

**MOSFET – Power,
 N-Channel, Automotive,
 SUPERFET® III, Easy-Drive**

650 V, 25 mΩ

NVCR8LS025N65S3A



Features

- Typical $R_{DS(on)} = 19.9\text{ m}\Omega$ at $V_{GS} = 10\text{ V}$
- Typical $Q_{g(tot)} = 236\text{ nC}$ at $V_{GS} = 10\text{ V}$
- AEC-Q101 Qualified
- RoHS Compliant

DIMENSION (μm)

Die Size	10830 x 7610
Die Size (Sawn)	10810 \pm 30 x 7590 \pm 30
Source Attach Area	(10155 x 3346) x 2
Gate Attach Area	406 x 618
Die Thickness	203.2 \pm 25.4

Gate and Source : AlSiCu
 Drain : Ti-NiV-Ag (back side of die)
 Passivation : SiN
 Wafer Diameter : 8 inch
 Wafer sawn on UV Tape
 Bad dice identified in Inking
 Gross Die Count : 296

ORDERING INFORMATION

Device	Package
NVCR8LS025N65S3A	Wafer Sawn on Foil

RECOMMENDED STORAGE CONDITIONS

Temperature	22 to 28°C
RH	40% to 66%

ELECTRICAL CHARACTERISTICS

The Chip is 100% Probed to Meet the Conditions and Limits Specified at $T_J = 25^\circ\text{C}$

Symbol	Parameter	Condition	Min.	Typ.	Max.	Unit
BV_{DSS}	Drain to Source Breakdown Voltage	$I_D = 1\text{ mA}, V_{GS} = 0\text{ V}$	650	-	-	V
I_{DSS}	Drain to Source Leakage Current	$V_{DS} = 650\text{ V}, V_{GS} = 0\text{ V}$	-	-	1	μA
I_{GSS}	Gate to Source Leakage Current	$V_{GS} = +30 / -20\text{ V}, V_{DS} = 0\text{ V}$	-	-	± 100	nA
$V_{GS(th)}$	Gate to Source Threshold Voltage	$V_{GS} = V_{DS}, I_D = 3\text{ mA}$	2.5	-	4.5	V
* $R_{DS(on)}$	Bare Die Drain to Source On Resistance	$I_D = 37.5\text{ A}, V_{GS} = 10\text{ V}$	-	19.9	25	$\text{m}\Omega$
V_{SD}	Drain to Source Diode Forward Voltage	$V_{GS} = 0\text{ V}, I_{SD} = 37.5\text{ V}$			1.2	V

*Accurate $R_{DS(on)}$ test at die level is not feasible for this thin die as limited by the test contact precision attainable in a die form. The max $R_{DS(on)}$ specification is defined from the historical performance of the die in package but is not guaranteed by test in production. The die $R_{DS(on)}$ performance depends on the Source wire/ribbon bonding layout.

NVCR8LS025N65S3A

ABSOLUTE MAXIMUM RATINGS

in Reference to the NVHL025N65S3 electrical data in TO-247-3LD ($T_J = 25^\circ\text{C}$ unless otherwise noted)

Symbol	Parameter	Ratings	Unit
V_{DSS}	Drain to Source Voltage	650	V
V_{GS}	Gate to Source Voltage	DC Positive	30
		AC Positive, (f > 1Hz)	30
		AC Negative, (f > 1Hz)	-20
I_D	Continuous Drain Current	$T_C = 25^\circ\text{C}$	75
		$T_C = 100^\circ\text{C}$	65.8
I_{DM}	Pulsed Drain Current	Pulsed (Note 1)	300
E_{AS}	Single Pulse Avalanche Energy (Note 2)	2025	mJ
E_{AR}	Repetitive Avalanche (Note 1)	5.95	mJ
dv/dt	MOSFET dv/dt	100	V/ns
	Peak Diode Recovery dv/dt (Note 3)	20	V/ns
P_D	Power Dissipation $R_{\theta JC}$	$T_C = 25^\circ\text{C}$	595
T_J, T_{STG}	Operating and Storage Temperature	-55 to +150	$^\circ\text{C}$

Stresses exceeding those listed in the Maximum Ratings table may damage the device. If any of these limits are exceeded, device functionality should not be assumed, damage may occur and reliability may be affected.

1. Repetitive rating; pulse-width limited by maximum junction temperature.
2. $I_{AS} = 15\text{ A}$, $R_G = 25\ \Omega$, Starting $T_J = 25^\circ\text{C}$.
3. $I_{SD} < 75\text{ A}$, $di/dt \leq 200\text{ A/ms}$, $V_{DD} \leq BVDSS$, starting $T_J = 25^\circ\text{C}$

THERMAL CHARACTERISTICS

Symbol	Parameter	Value	Unit
$R_{\theta JC}$	Thermal Resistance, Junction to Case, Max	0.21	$^\circ\text{C/W}$
$R_{\theta JA}$	Thermal Resistance, Junction to Ambient, Max	40	$^\circ\text{C/W}$

NVCR8LS025N65S3A

ELECTRICAL CHARACTERISTICS

in Reference to the NVHL025N65S3 electrical data in TO-247-3LD ($T_J = 25^\circ\text{C}$ unless otherwise noted)

Symbol	Parameter	Conditions	Min.	Typ.	Max.	Unit
OFF CHARACTERISTICS						
BV_{DSS}	Drain to Source Breakdown Voltage	$I_D = 1 \text{ mA}, V_{GS} = 0 \text{ V}$	650	-	-	V
I_{DSS}	Drain to Source Leakage Current	$V_{DS} = 650 \text{ V}, V_{GS} = 0 \text{ V}, T_J = 25^\circ\text{C}$	-	-	1	μA
		$V_{DS} = 520 \text{ V}, V_{GS} = 0 \text{ V}, T_J = 125^\circ\text{C}$	-	7.92	-	μA
I_{GSS}	Gate to Source Leakage Current	$V_{GS} = +30 \text{ V}$	-	-	+100	nA
		$V_{GS} = -20 \text{ V}$			-100	nA

ON CHARACTERISTICS

$V_{GS(th)}$	Gate to Source Threshold Voltage	$V_{GS} = V_{DS}, I_D = 3.0 \text{ mA}$	2.5		4.5	V	
$R_{DS(on)}$	Drain to Source On-Resistance	$I_D = 37.5 \text{ A}, V_{GS} = 10 \text{ V}$	$T_J = 25^\circ\text{C}$	-	19.9	25	$\text{m}\Omega$
			$T_J = 100^\circ\text{C}$	-	34.6	-	$\text{m}\Omega$
g_{FS}	Forward Transconductance	$V_{DS} = 20 \text{ V}, I_D = 75 \text{ A}$		78.5		S	

DYNAMIC CHARACTERISTICS

C_{iss}	Input Capacitance	$V_{DS} = 400 \text{ V}, V_{GS} = 0 \text{ V}, f = 1 \text{ MHz}$	-	7330	-	pF
C_{oss}	Output Capacitance		-	197	-	pF
C_{rss}	Reverse Transfer Capacitance		-	33.6	-	pF
$C_{oss(eff.)}$	Effective Output Capacitance	$V_{DS} = 0 \text{ V to } 400 \text{ V}, V_{GS} = 0 \text{ V}$		2062		pF
$C_{oss(er.)}$	Energy Related Output Capacitance	$V_{DS} = 0 \text{ V to } 400 \text{ V}, V_{GS} = 0 \text{ V}$		285		pF
$Q_{g(ToT)}$	Total Gate Charge	$V_{GS} = 10 \text{ V}, V_{DS} = 400 \text{ V}, I_D = 75 \text{ A}$ (Note 4)	-	236	-	nC
Q_{gs}	Gate to Source Gate Charge		-	59.3	-	nC
Q_{gd}	Gate to Drain "Miller" Charge		-	97.3	-	nC
R_G	Gate Resistance	$f = 1 \text{ MHz}$	-	0.818	-	Ω

SWITCHING CHARACTERISTICS

$t_{d(on)}$	Turn-On Delay Time	$V_{DD} = 400 \text{ V}, I_D = 75 \text{ A}, V_{GS} = 10 \text{ V}, R_G = 2 \Omega$ (Note 4)	-	43.3	-	ns
t_r	Rise Time		-	109	-	ns
$t_{d(off)}$	Turn-Off Delay Time		-	120	-	ns
t_f	Fall Time		-	107	-	ns

DRAIN - SOURCE DIODE CHARACTERISTICS

I_S	Maximum Continuous Drain to Source Diode Forward Current				75	A
I_{SM}	Maximum Pulsed Drain to Source Diode Forward Current				300	A
V_{SD}	Source to Drain Diode Voltage	$V_{GS} = 0 \text{ V}, I_{SD} = 37.5 \text{ A}, V_{GS} = 0 \text{ V}$	-	-	1.2	V
t_{rr}	Reverse Recovery Time	$V_{GS} = 0 \text{ V}, I_{SD} = 75 \text{ A}, dI_{SD}/dt = 100 \text{ A}/\mu\text{s}$	-	714	-	ns
Q_{rr}	Reverse Recovery Charge		-	26.4	-	μC

Product parametric performance is indicated in the Electrical Characteristics for the listed test conditions, unless otherwise noted. Product performance may not be indicated by the Electrical Characteristics if operated under different conditions.

4. Essentially independent of operating temperature typical characteristics.

NVCR8LS025N65S3A

TYPICAL CHARACTERISTICS

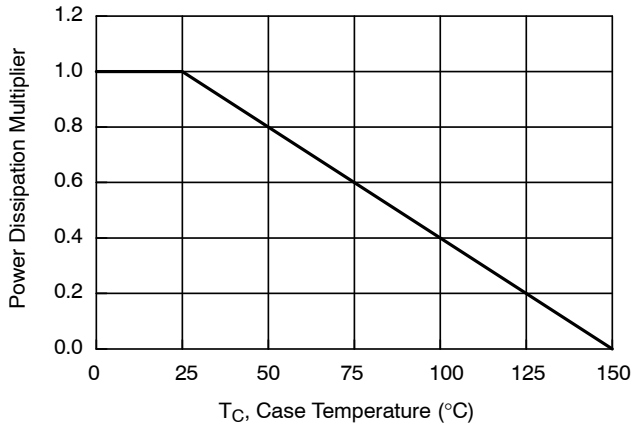

Figure 1. Normalized Power Dissipation vs. Case Temperature

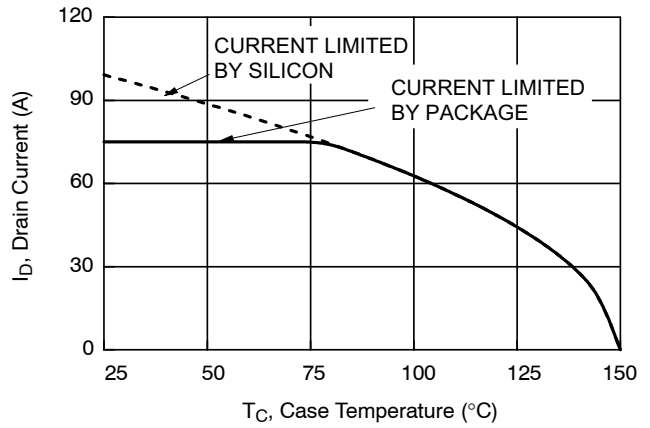

Figure 2. Maximum Continuous Drain Current vs. Case Temperature

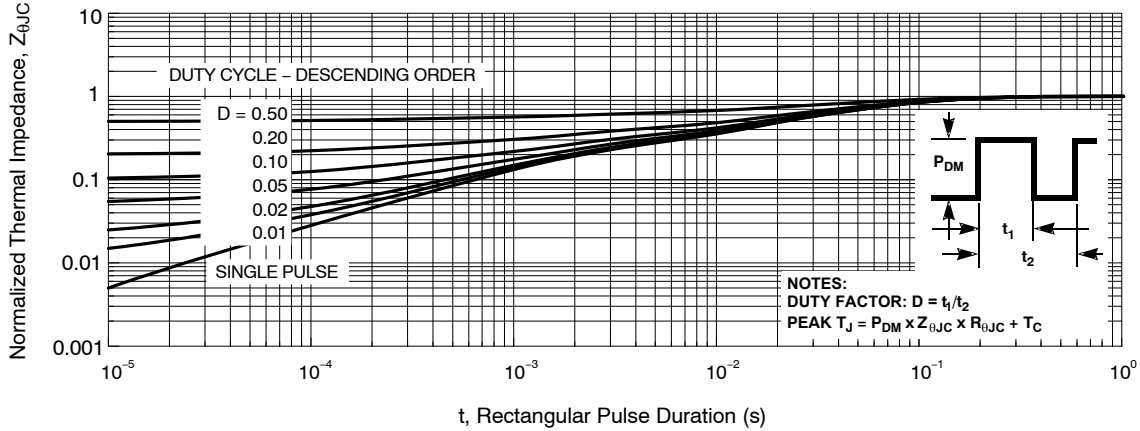

Figure 3. Normalized Maximum Transient Thermal Impedance

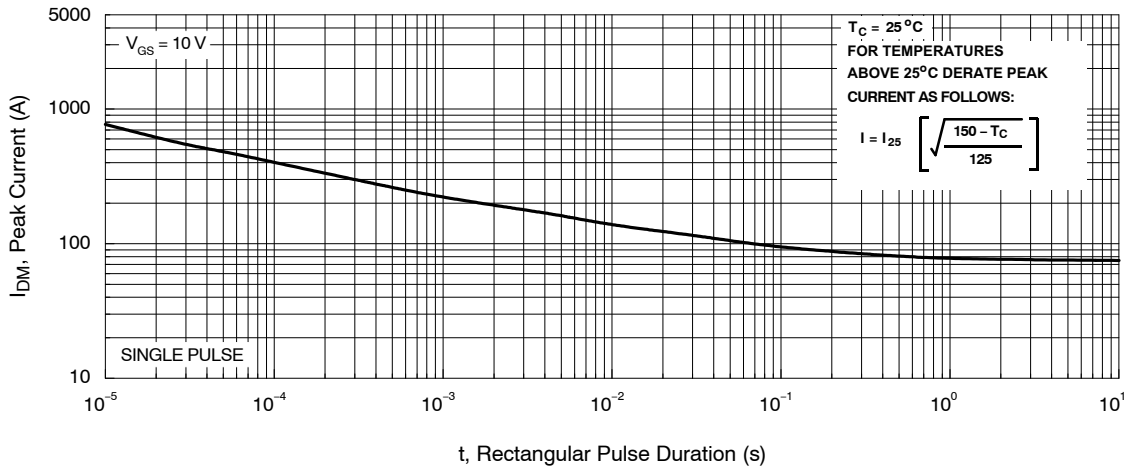

Figure 4. Peak Current Capability

TYPICAL CHARACTERISTICS (continued)

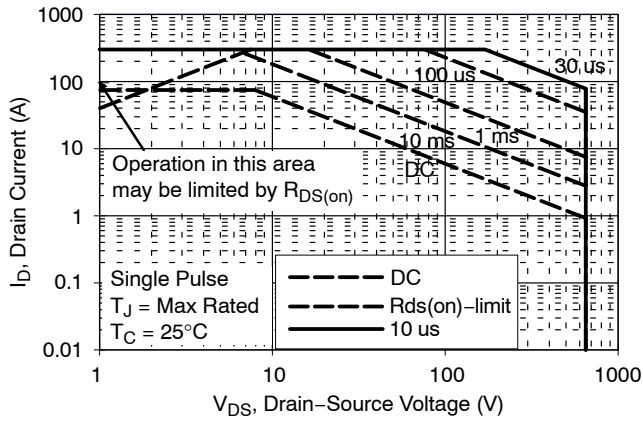

Figure 5. Forward Bias Safe Operating Area

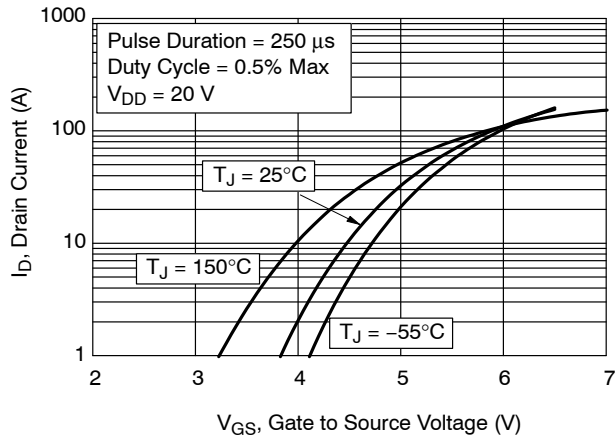

Figure 6. Transfer Characteristic

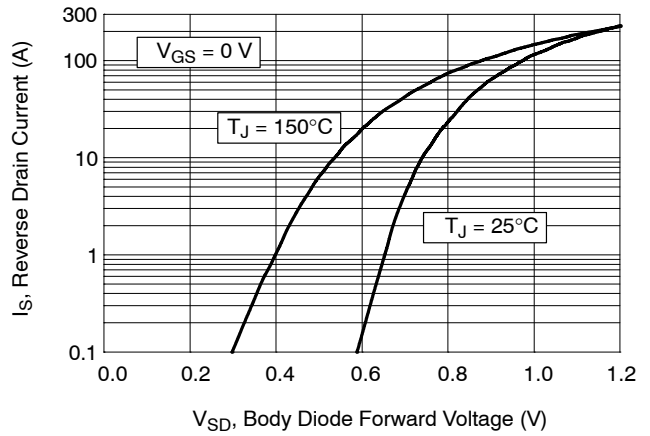

Figure 7. Forward Diode Characteristics

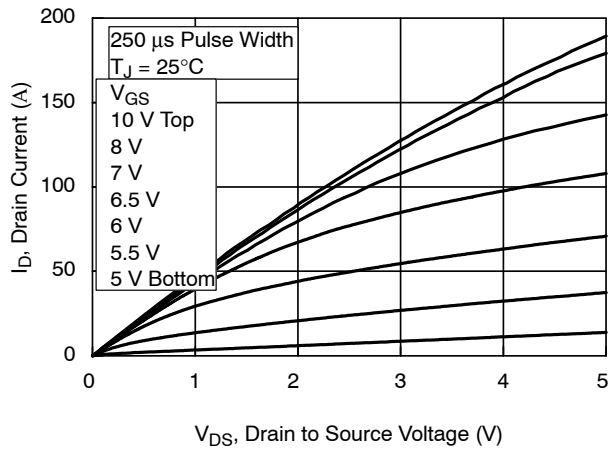

Figure 8. Saturation Characteristics

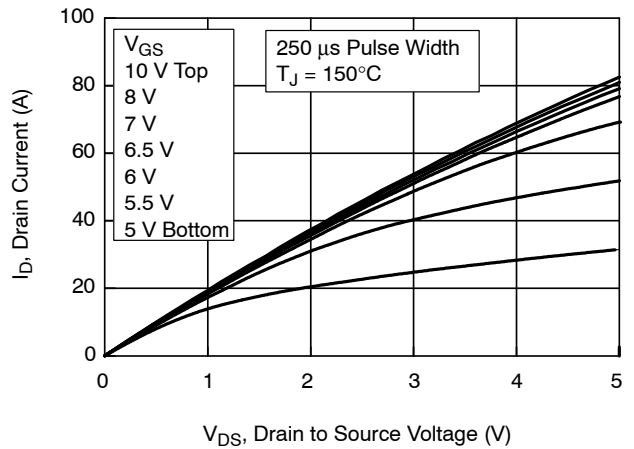

Figure 9. Saturation Characteristics

NVCR8LS025N65S3A

TYPICAL CHARACTERISTICS (continued)

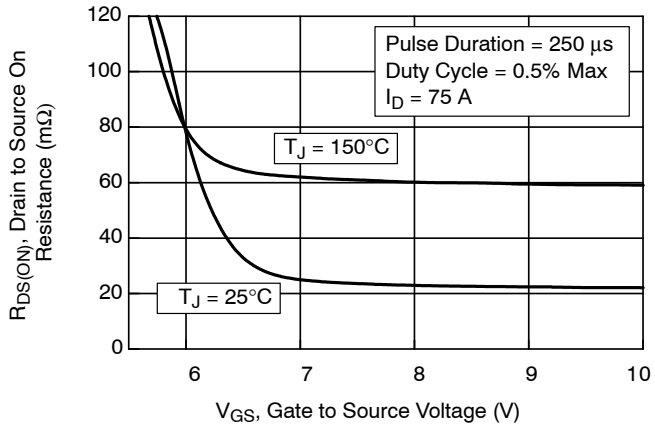

Figure 10. $R_{DS(on)}$ vs. Gate Voltage

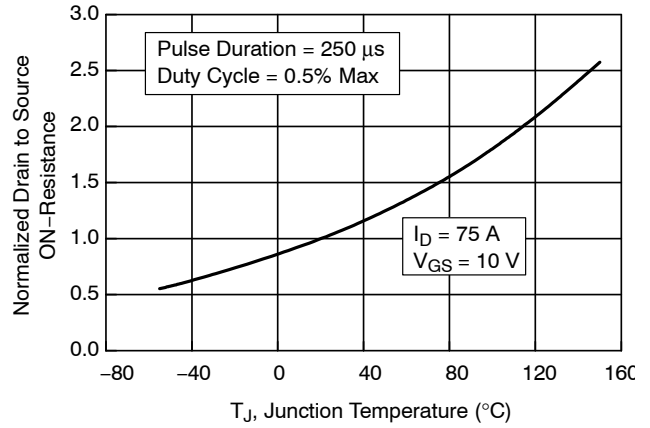

Figure 11. Normalized $R_{DS(on)}$ vs. Junction Temperature

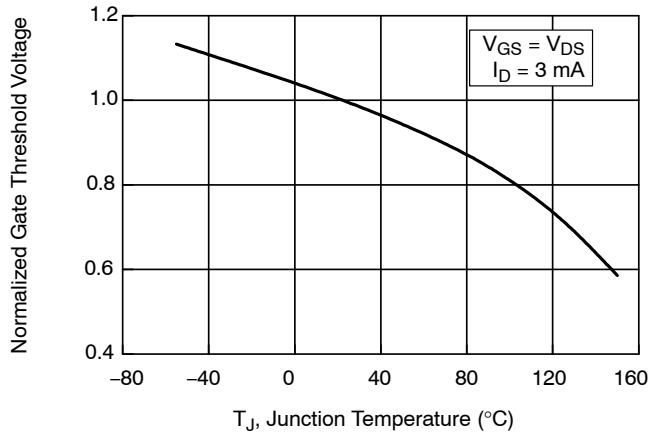

Figure 12. Normalized Gate Threshold Voltage vs. Temperature

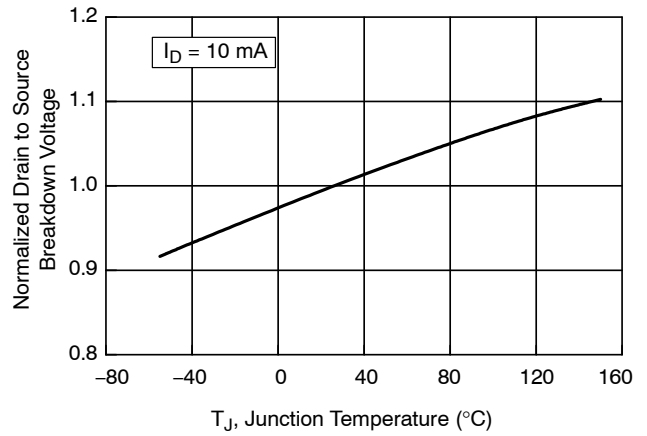

Figure 13. Normalized Drain to Source Breakdown Voltage vs. Junction Temperature

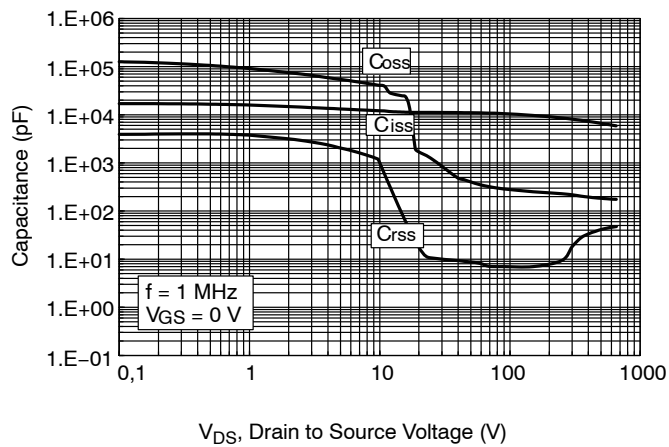

Figure 14. Capacitance vs. Drain to Source Voltage

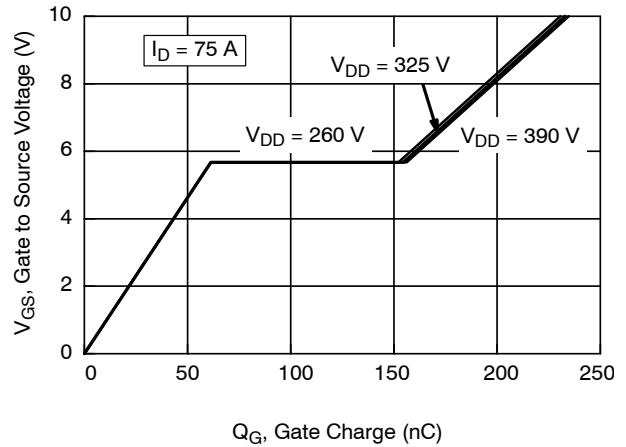

Figure 15. Gate Charge vs. Gate to Source Voltage

NVCR8LS025N65S3A

TYPICAL CHARACTERISTICS (continued)

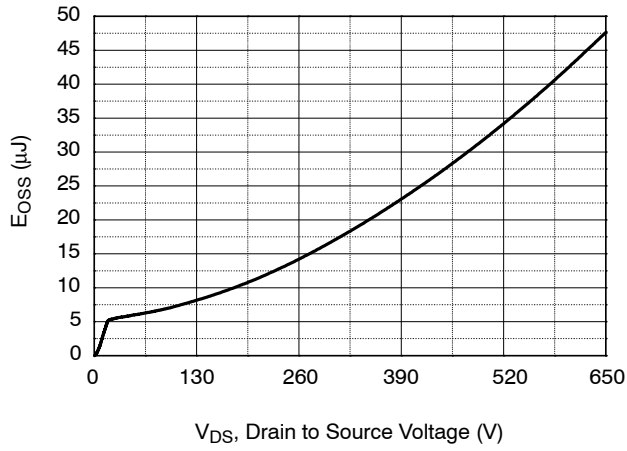

Figure 16. E_{OSS} vs. Drain to Source Voltage

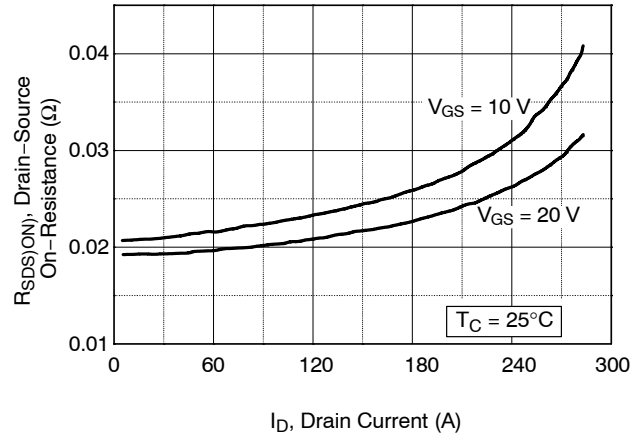

Figure 17. On-Resistance Variation vs. Drain Current and Gate Voltage

onsemi, **Onsemi**, and other names, marks, and brands are registered and/or common law trademarks of Semiconductor Components Industries, LLC dba "**onsemi**" or its affiliates and/or subsidiaries in the United States and/or other countries. **onsemi** owns the rights to a number of patents, trademarks, copyrights, trade secrets, and other intellectual property. A listing of **onsemi**'s product/patent coverage may be accessed at www.onsemi.com/site/pdf/Patent-Marking.pdf. **onsemi** reserves the right to make changes at any time to any products or information herein, without notice. The information herein is provided "as-is" and **onsemi** makes no warranty, representation or guarantee regarding the accuracy of the information, product features, availability, functionality, or suitability of its products for any particular purpose, nor does **onsemi** assume any liability arising out of the application or use of any product or circuit, and specifically disclaims any and all liability, including without limitation special, consequential or incidental damages. Buyer is responsible for its products and applications using **onsemi** products, including compliance with all laws, regulations and safety requirements or standards, regardless of any support or applications information provided by **onsemi**. "Typical" parameters which may be provided in **onsemi** data sheets and/or specifications can and do vary in different applications and actual performance may vary over time. All operating parameters, including "Typicals" must be validated for each customer application by customer's technical experts. **onsemi** does not convey any license under any of its intellectual property rights nor the rights of others. **onsemi** products are not designed, intended, or authorized for use as a critical component in life support systems or any FDA Class 3 medical devices or medical devices with a same or similar classification in a foreign jurisdiction or any devices intended for implantation in the human body. Should Buyer purchase or use **onsemi** products for any such unintended or unauthorized application, Buyer shall indemnify and hold **onsemi** and its officers, employees, subsidiaries, affiliates, and distributors harmless against all claims, costs, damages, and expenses, and reasonable attorney fees arising out of, directly or indirectly, any claim of personal injury or death associated with such unintended or unauthorized use, even if such claim alleges that **onsemi** was negligent regarding the design or manufacture of the part. **onsemi** is an Equal Opportunity/Affirmative Action Employer. This literature is subject to all applicable copyright laws and is not for resale in any manner.

PUBLICATION ORDERING INFORMATION

LITERATURE FULFILLMENT:

Email Requests to: orderlit@onsemi.com

onsemi Website: www.onsemi.com

TECHNICAL SUPPORT

North American Technical Support:

Voice Mail: 1 800-282-9855 Toll Free USA/Canada

Phone: 011 421 33 790 2910

Europe, Middle East and Africa Technical Support:

Phone: 00421 33 790 2910

For additional information, please contact your local Sales Representative