

Industrial Inductive Load Driver

NUD3160, SZNUD3160

This micro-integrated part provides a single component solution to switch inductive loads such as relays, solenoids, and small DC motors without the need of a free-wheeling diode. It accepts logic level inputs, thus allowing it to be driven by a large variety of devices including logic gates, inverters, and microcontrollers.

Features

- Provides Robust Interface between D.C. Relay Coils and Sensitive Logic
- Capable of Driving Relay Coils Rated up to 150 mA at 12 V, 24 V or 48 V
- Replaces 3 or 4 Discrete Components for Lower Cost
- Internal Zener Eliminates Need for Free-Wheeling Diode
- Meets Load Dump and other Automotive Specs
- SZ Prefix for Automotive and Other Applications Requiring Unique Site and Control Change Requirements; AEC-Q101 Qualified and PPAP Capable
- These Devices are Pb-Free, Halogen Free/BFR Free and are RoHS Compliant

Typical Applications

- Automotive and Industrial Environment
- Drives Window, Latch, Door, and Antenna Relays

Benefits

- Reduced PCB Space
- Standardized Driver for Wide Range of Relays
- Simplifies Circuit Design and PCB Layout
- Compliance with Automotive Specifications



SOT-23
CASE 318
STYLE 21



SC-74
CASE 318F
STYLE 7

MARKING DIAGRAMS

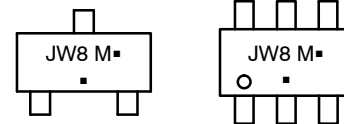

JW8 = Specific Device Code
M = Date Code
▪ = Pb-Free Package
(Note: Microdot may be in either location)

JW8 = Specific Device Code
M = Date Code
▪ = Pb-Free Package
(Note: Microdot may be in either location)

ORDERING INFORMATION

Device	Package	Shipping [†]
SZNUD3160LT1G	SOT-23 (Pb-Free)	3000 / Tape & Reel
SZNUD3160DMT1G	SC-74 (Pb-Free)	3000 / Tape & Reel

DISCONTINUED (Note 1)

NU31D60LT1G	SOT-23 (Pb-Free)	3000 / Tape & Reel
NUD3160DMT1G	SC-74 (Pb-Free)	3000 / Tape & Reel

[†]For information on tape and reel specifications, including part orientation and tape sizes, please refer to our Tape and Reel Packaging Specifications Brochure, [BRD8011/D](#).

1. **DISCONTINUED:** These devices are not recommended for new design. Please contact your **onsemi** representative for information. The most current information on these devices may be available on [www.onsemi.com](#).

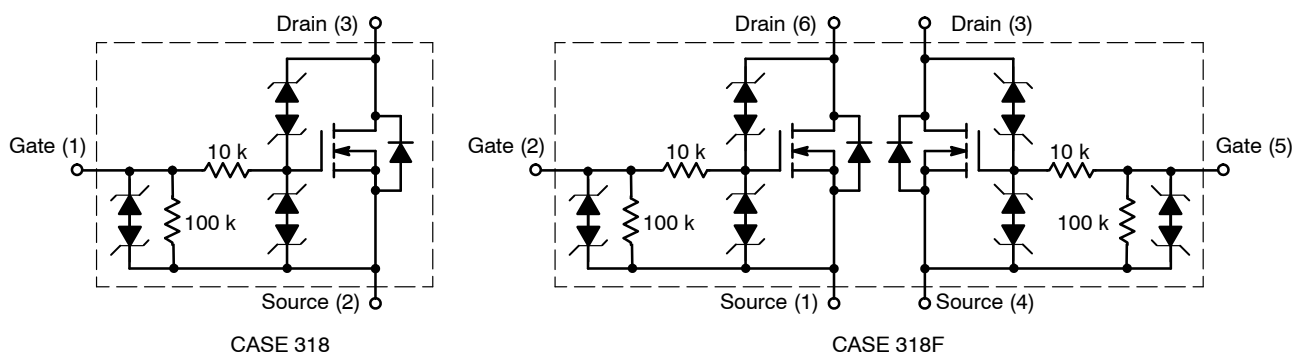

Figure 1. Internal Circuit Diagrams

NUD3160, SZNUD3160

MAXIMUM RATINGS (T_J = 25°C unless otherwise specified)

Symbol	Rating	Value	Unit
V _{DSS}	Drain-to-Source Voltage – Continuous (T _J = 125°C)	60	V
V _{GSS}	Gate-to-Source Voltage – Continuous (T _J = 125°C)	12	V
I _D	Drain Current – Continuous (T _J = 125°C) Minimum copper, double sided board, T _A = 80°C SOT-23 SC74 Single device driven SC74 Both devices driven 1 in ² copper, double sided board, T _A = 25°C SOT-23 SC74 Single device driven SC74 Both devices driven	158 157 132 ea 272 263 230 ea	mA
E _Z	Single Pulse Drain-to-Source Avalanche Energy (For Relay's Coils/Inductive Loads of 80 Ω or Higher) (T _J Initial = 85°C)	200	mJ
P _{PK}	Peak Power Dissipation, Drain-to-Source (Notes 2 and 3) (T _J Initial = 85°C)	20	W
E _{LD1}	Load Dump Pulse, Drain-to-Source (Note 4) R _{SOURCE} = 0.5 Ω, T = 300 ms (For Relay's Coils/Inductive Loads of 80 Ω or Higher) (T _J Initial = 85°C)	60	V
E _{LD2}	Inductive Switching Transient 1, Drain-to-Source (Waveform: R _{SOURCE} = 10 Ω, T = 2.0 ms) (For Relay's Coils/Inductive Loads of 80 Ω or Higher) (T _J Initial = 85°C)	100	V
E _{LD3}	Inductive Switching Transient 2, Drain-to-Source (Waveform: R _{SOURCE} = 4.0 Ω, T = 50 μs) (For Relay's Coils/Inductive Loads of 80 Ω or Higher) (T _J Initial = 85°C)	300	V
Rev-Bat	Reverse Battery, 10 Minutes (Drain-to-Source) (For Relay's Coils/Inductive Loads of 80 Ω or more)	-14	V
Dual-Volt	Dual Voltage Jump Start, 10 Minutes (Drain-to-Source)	28	V
ESD	Human Body Model (HBM) According to EIA/JESD22/A114 Specification	2000	V

Stresses exceeding those listed in the Maximum Ratings table may damage the device. If any of these limits are exceeded, device functionality should not be assumed, damage may occur and reliability may be affected.

THERMAL CHARACTERISTICS

Symbol	Rating	Value	Unit	
T _A	Operating Ambient Temperature	-40 to 125	°C	
T _J	Maximum Junction Temperature	150	°C	
T _{STG}	Storage Temperature Range	-65 to 150	°C	
P _D	Total Power Dissipation (Note 5) Derating above 25°C	SOT-23 225 1.8	mW mW/°C	
P _D	Total Power Dissipation (Note 5) Derating above 25°C	SC-74 380 3.0	mW mW/°C	
R _{θJA}	Thermal Resistance, Junction-to-Ambient Minimum Copper 300 mm ² Copper	SOT-23 SC-74 One Device Powered SC-74 Both Devices Equally Powered SOT-23 SC-74 One Device Powered SC-74 Both Devices Equally Powered	556 556 398 395 420 270	°C/W

2. Nonrepetitive current square pulse 1.0 ms duration.
3. For different square pulse durations, see Figure 12.
4. Nonrepetitive load dump pulse per Figure 3.
5. Mounted onto minimum pad board.

NUD3160, SZNUD3160

ELECTRICAL CHARACTERISTICS (T_J = 25°C unless otherwise specified)

Characteristic	Symbol	Min	Typ	Max	Unit
OFF CHARACTERISTICS					
Drain to Source Sustaining Voltage (I _D = 10 mA)	V _{BRDSS}	61	66	70	V
Drain to Source Leakage Current (V _{DS} = 12 V, V _{GS} = 0 V) (V _{DS} = 12 V, V _{GS} = 0 V, T _J = 125°C) (V _{DS} = 60 V, V _{GS} = 0 V) (V _{DS} = 60 V, V _{GS} = 0 V, T _J = 125°C)	I _{DSS}	–	–	0.5 1.0 50 80	μA
Gate Body Leakage Current (V _{GS} = 3.0 V, V _{DS} = 0 V) (V _{GS} = 3.0 V, V _{DS} = 0 V, T _J = 125°C) (V _{GS} = 5.0 V, V _{DS} = 0 V) (V _{GS} = 5.0 V, V _{DS} = 0 V, T _J = 125°C)	I _{GSS}	–	–	60 80 90 110	μA
ON CHARACTERISTICS					
Gate Threshold Voltage (V _{GS} = V _{DS} , I _D = 1.0 mA) (V _{GS} = V _{DS} , I _D = 1.0 mA, T _J = 125°C)	V _{GS(th)}	1.3 1.3	1.8 –	2.0 2.0	V
Drain to Source On-Resistance (I _D = 150 mA, V _{GS} = 3.0 V) (I _D = 150 mA, V _{GS} = 3.0 V, T _J = 125°C) (I _D = 150 mA, V _{GS} = 5.0 V) (I _D = 150 mA, V _{GS} = 5.0 V, T _J = 125°C)	R _{DS(on)}	–	–	2.4 3.7 1.8 2.9	Ω
Output Continuous Current (V _{DS} = 0.3 V, V _{GS} = 5.0 V) (V _{DS} = 0.3 V, V _{GS} = 5.0 V, T _J = 125°C)	I _{DS(on)}	150 100	200 –	– –	mA
Forward Transconductance (V _{DS} = 12 V, I _D = 150 mA)	g _{FS}	–	400	–	mmho
DYNAMIC CHARACTERISTICS					
Input Capacitance (V _{DS} = 12 V, V _{GS} = 0 V, f = 10 kHz)	C _{iss}	–	30	–	pf
Output Capacitance (V _{DS} = 12 V, V _{GS} = 0 V, f = 10 kHz)	C _{oss}	–	14	–	pf
Transfer Capacitance (V _{DS} = 12 V, V _{GS} = 0 V, f = 10 kHz)	C _{rss}	–	6.0	–	pf
SWITCHING CHARACTERISTICS					
Propagation Delay Times: High to Low Propagation Delay; Figure 2, (V _{DS} = 12 V, V _{GS} = 3.0 V) Low to High Propagation Delay; Figure 2, (V _{DS} = 12 V, V _{GS} = 3.0 V) High to Low Propagation Delay; Figure 2, (V _{DS} = 12 V, V _{GS} = 5.0 V) Low to High Propagation Delay; Figure 2, (V _{DS} = 12 V, V _{GS} = 5.0 V)	t _{PHL} t _{PLH} t _{PHL} t _{PLH}	– – – –	918 798 331 1160	– – – –	ns
Transition Times: Fall Time; Figure 2, (V _{DS} = 12 V, V _{GS} = 3.0 V) Rise Time; Figure 2, (V _{DS} = 12 V, V _{GS} = 3.0 V) Fall Time; Figure 2, (V _{DS} = 12 V, V _{GS} = 5.0 V) Rise Time; Figure 2, (V _{DS} = 12 V, V _{GS} = 5.0 V)	t _f t _r t _f t _r	– – – –	2290 618 622 600	– – – –	ns

Product parametric performance is indicated in the Electrical Characteristics for the listed test conditions, unless otherwise noted. Product performance may not be indicated by the Electrical Characteristics if operated under different conditions.

NUD3160, SZNUD3160

TYPICAL WAVEFORMS

($T_J = 25^\circ\text{C}$ unless otherwise specified)

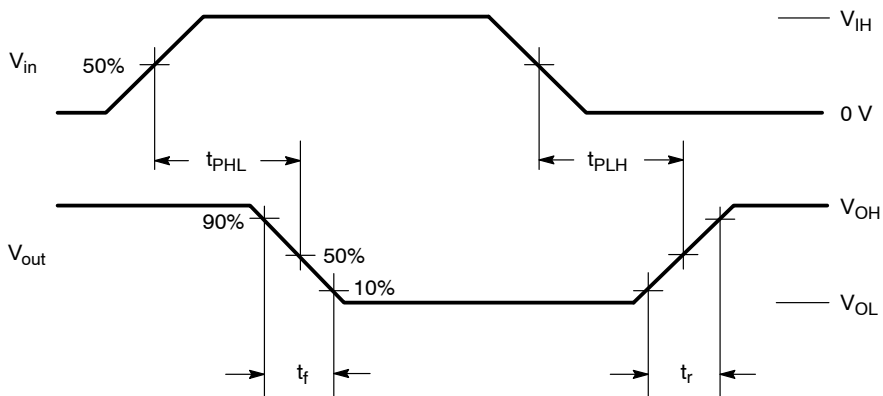

Figure 2. Switching Waveforms

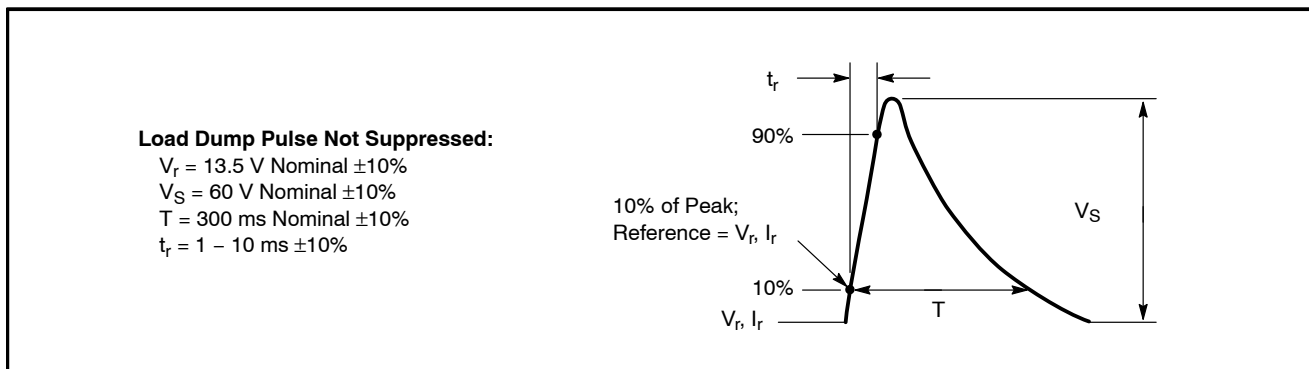

Figure 3. Load Dump Waveform Definition

NUD3160, SZNUD3160

TYPICAL PERFORMANCE CURVES

($T_J = 25^\circ\text{C}$ unless otherwise specified)

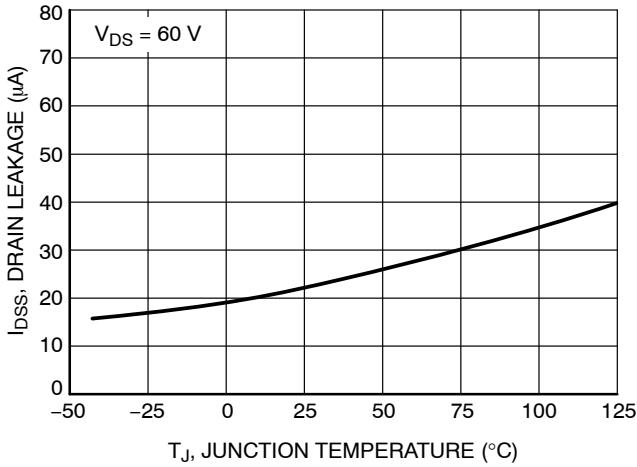

Figure 4. Drain-to-Source Leakage vs. Junction Temperature

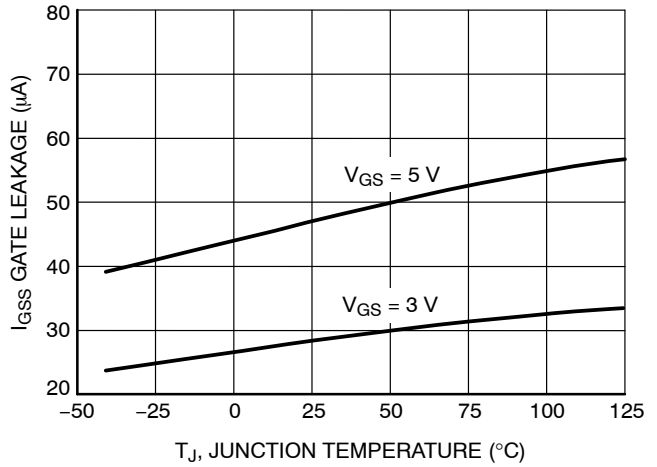

Figure 5. Gate-to-Source Leakage vs. Junction Temperature

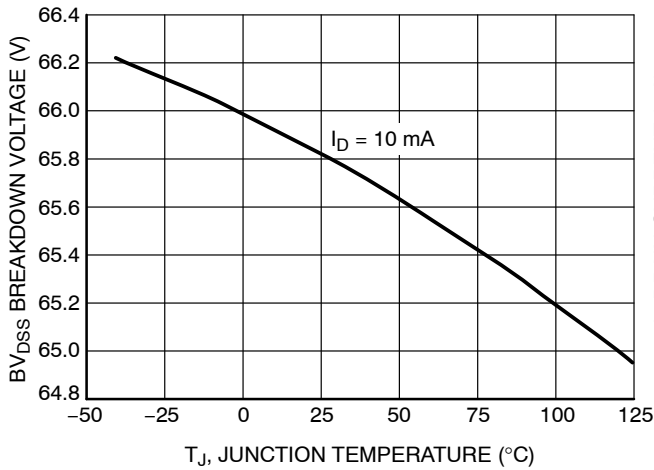

Figure 6. Breakdown Voltage vs. Junction Temperature

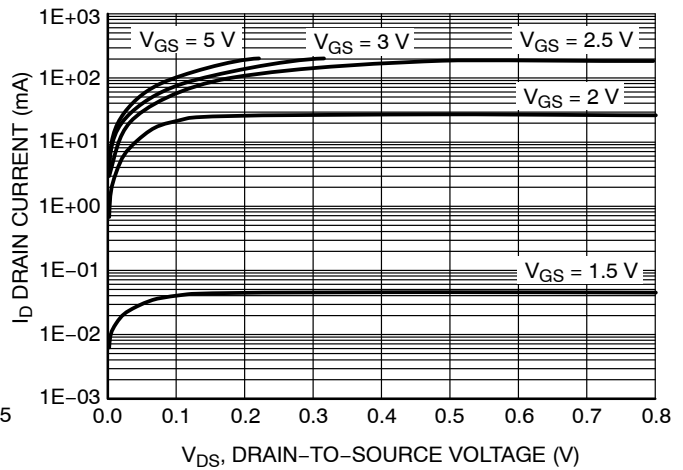

Figure 7. Output Characteristics

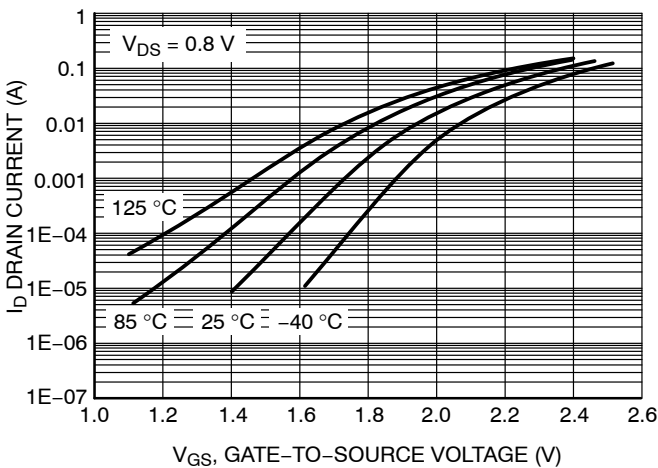

Figure 8. Transfer Function

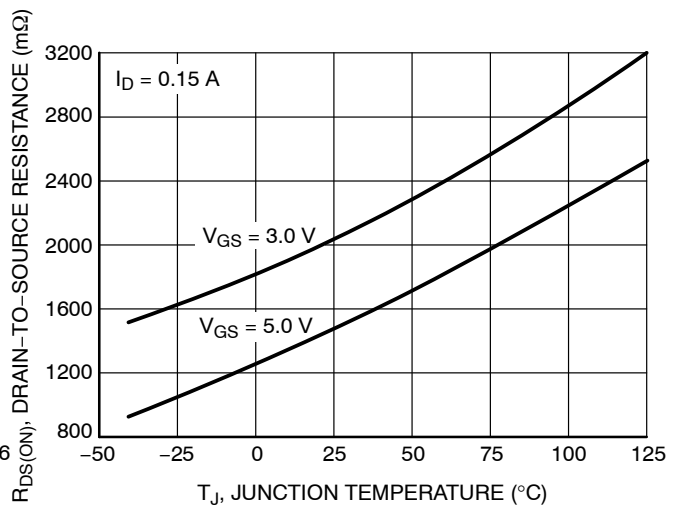

Figure 9. On Resistance Variation vs. Junction Temperature

NUD3160, SZNUD3160

TYPICAL PERFORMANCE CURVES

($T_J = 25^\circ\text{C}$ unless otherwise specified)

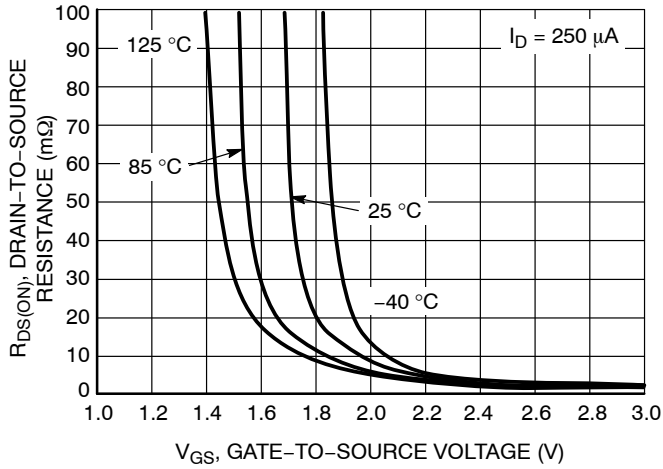

Figure 10. On Resistance Variation vs. Gate-to-Source Voltage

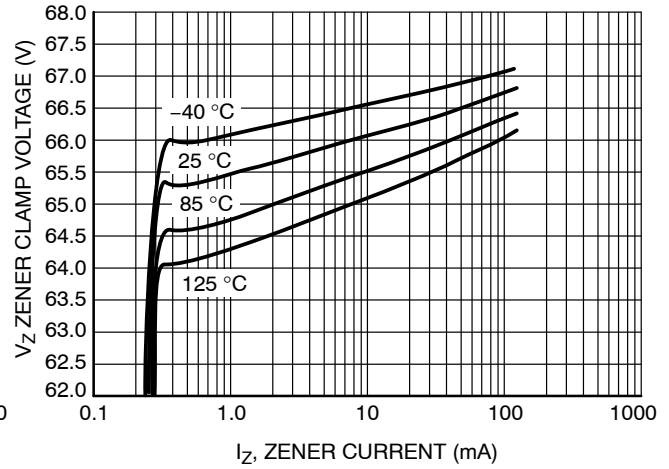

Figure 11. Zener Clamp Voltage vs. Zener Current

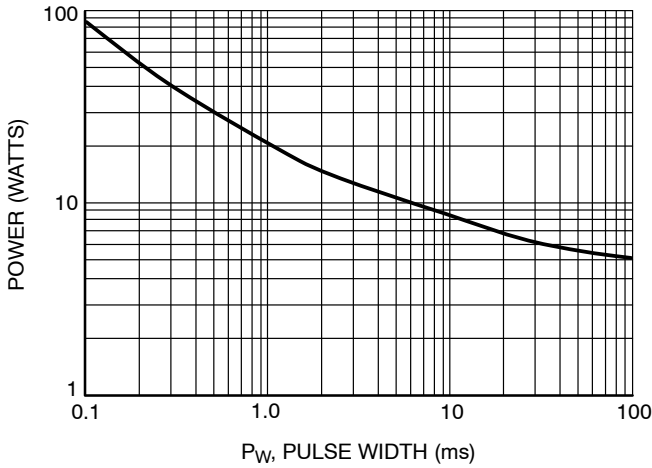

Figure 12. Maximum Non-repetitive Surge Power vs. Pulse Width

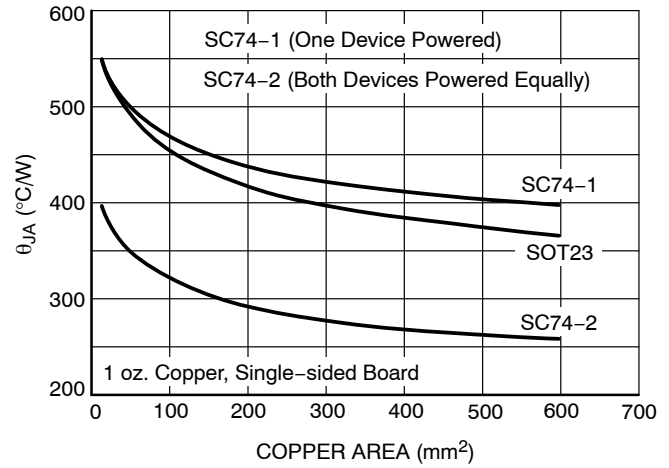

Figure 13. Thermal Performance vs. Board Copper Area

NUD3160, SZNUD3160

APPLICATIONS INFORMATION

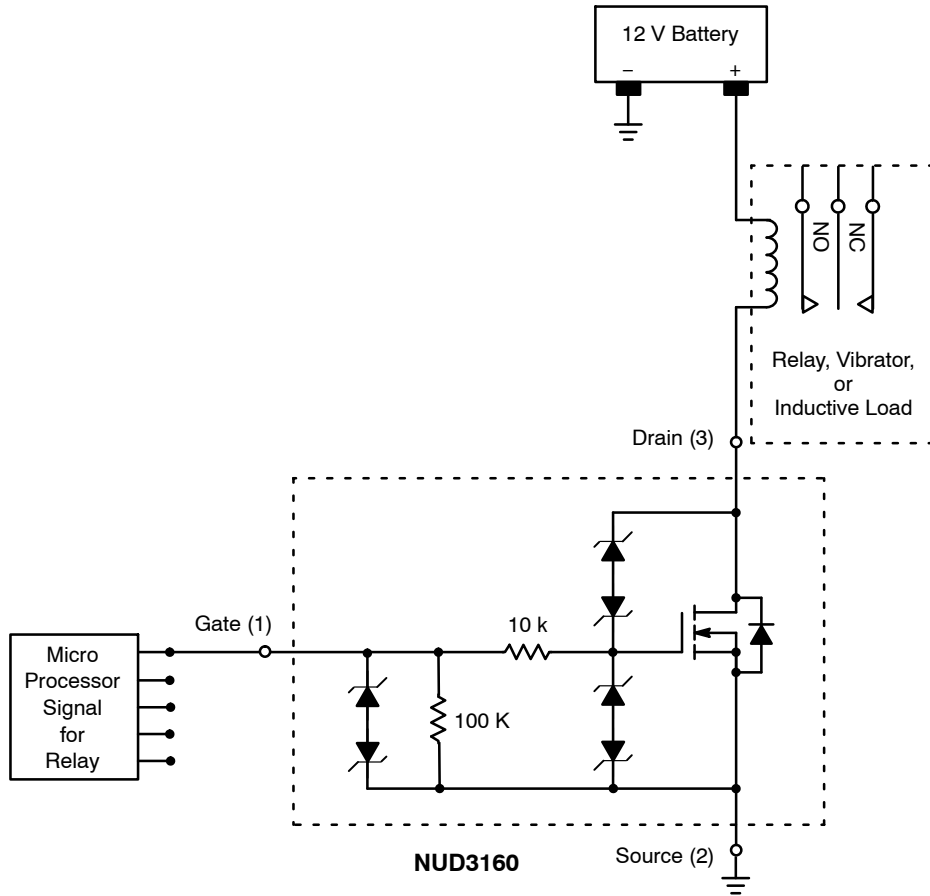
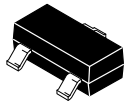

Figure 14. Applications Diagram



SCALE 4:1

SOT-23 (TO-236) 2.90x1.30x1.00 1.90P
CASE 318
ISSUE AU

DATE 14 AUG 2024

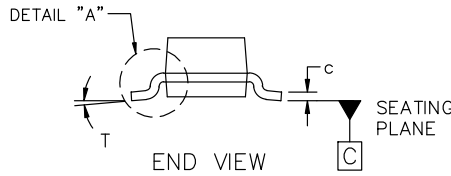
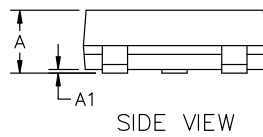
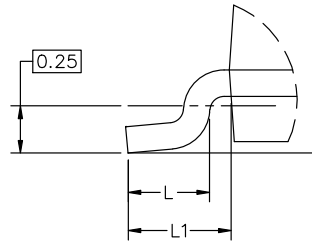
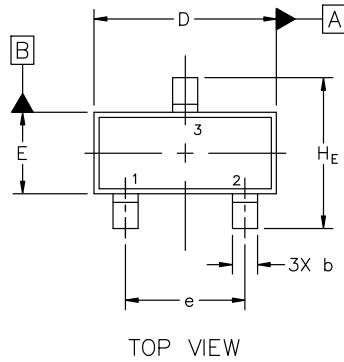

MILLIMETERS			
DIM	MIN	NOM	MAX
A	0.89	1.00	1.11
A1	0.01	0.06	0.10
b	0.37	0.44	0.50
c	0.08	0.14	0.20
D	2.80	2.90	3.04
E	1.20	1.30	1.40
e	1.78	1.90	2.04
L	0.30	0.43	0.55
L1	0.35	0.54	0.69
HE	2.10	2.40	2.64
T	0°	---	10°

NOTES:

1. DIMENSIONING AND TOLERANCING PER ASME Y14.5M, 2018.
2. CONTROLLING DIMENSIONS: MILLIMETERS.
3. MAXIMUM LEAD THICKNESS INCLUDES LEAD FINISH. MINIMUM LEAD THICKNESS IS THE MINIMUM THICKNESS OF THE BASE MATERIAL.
4. DIMENSIONS D AND E DO NOT INCLUDE MOLD FLASH, PROTRUSIONS, OR GATE BURRS.

GENERIC MARKING DIAGRAM*

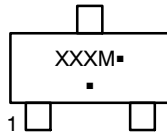

XXX = Specific Device Code
M = Date Code
▪ = Pb-Free Package

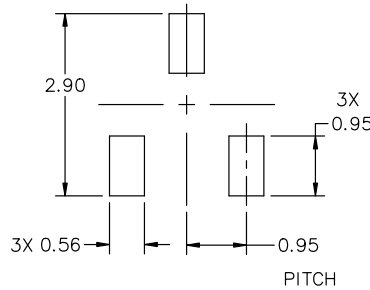

* For additional information on our Pb-Free strategy and soldering details, please download the onsemi Soldering and Mounting Techniques Reference Manual, SOLDERRM/D.

*This information is generic. Please refer to device data sheet for actual part marking. Pb-Free indicator, "G" or microdot "▪", may or may not be present. Some products may not follow the Generic Marking.

STYLES ON PAGE 2

DOCUMENT NUMBER:	98ASB42226B	Electronic versions are uncontrolled except when accessed directly from the Document Repository. Printed versions are uncontrolled except when stamped "CONTROLLED COPY" in red.
DESCRIPTION:	SOT-23 (TO-236) 2.90x1.30x1.00 1.90P	PAGE 1 OF 2

onsemi and ONSEMI are trademarks of Semiconductor Components Industries, LLC dba onsemi or its subsidiaries in the United States and/or other countries. onsemi reserves the right to make changes without further notice to any products herein. onsemi makes no warranty, representation or guarantee regarding the suitability of its products for any particular purpose, nor does onsemi assume any liability arising out of the application or use of any product or circuit, and specifically disclaims any and all liability, including without limitation special, consequential or incidental damages. onsemi does not convey any license under its patent rights nor the rights of others.

SOT-23 (TO-236) 2.90x1.30x1.00 1.90P
CASE 318
ISSUE AU

DATE 14 AUG 2024

STYLE 1 THRU 5:
CANCELLED

STYLE 6:
PIN 1. BASE
2. EMITTER
3. COLLECTOR

STYLE 7:
PIN 1. EMITTER
2. BASE
3. COLLECTOR

STYLE 8:
PIN 1. ANODE
2. NO CONNECTION
3. CATHODE

STYLE 9:
PIN 1. ANODE
2. ANODE
3. CATHODE

STYLE 10:
PIN 1. DRAIN
2. SOURCE
3. GATE

STYLE 11:
PIN 1. ANODE
2. CATHODE
3. CATHODE-ANODE

STYLE 12:
PIN 1. CATHODE
2. CATHODE
3. ANODE

STYLE 13:
PIN 1. SOURCE
2. DRAIN
3. GATE

STYLE 14:
PIN 1. CATHODE
2. GATE
3. ANODE

STYLE 15:
PIN 1. GATE
2. CATHODE
3. ANODE

STYLE 16:
PIN 1. ANODE
2. CATHODE
3. CATHODE

STYLE 17:
PIN 1. NO CONNECTION
2. ANODE
3. CATHODE

STYLE 18:
PIN 1. NO CONNECTION
2. CATHODE
3. ANODE

STYLE 19:
PIN 1. CATHODE
2. ANODE
3. CATHODE-ANODE

STYLE 20:
PIN 1. CATHODE
2. ANODE
3. GATE

STYLE 21:
PIN 1. GATE
2. SOURCE
3. DRAIN

STYLE 22:
PIN 1. RETURN
2. OUTPUT
3. INPUT

STYLE 23:
PIN 1. ANODE
2. ANODE
3. CATHODE

STYLE 24:
PIN 1. GATE
2. DRAIN
3. SOURCE

STYLE 25:
PIN 1. ANODE
2. CATHODE
3. GATE

STYLE 26:
PIN 1. CATHODE
2. ANODE
3. NO CONNECTION

STYLE 27:
PIN 1. CATHODE
2. CATHODE
3. CATHODE

STYLE 28:
PIN 1. ANODE
2. ANODE
3. ANODE

DOCUMENT NUMBER:	98ASB42226B	Electronic versions are uncontrolled except when accessed directly from the Document Repository. Printed versions are uncontrolled except when stamped "CONTROLLED COPY" in red.
DESCRIPTION:	SOT-23 (TO-236) 2.90x1.30x1.00 1.90P	PAGE 2 OF 2

onsemi and **ONSEMI** are trademarks of Semiconductor Components Industries, LLC dba **onsemi** or its subsidiaries in the United States and/or other countries. **onsemi** reserves the right to make changes without further notice to any products herein. **onsemi** makes no warranty, representation or guarantee regarding the suitability of its products for any particular purpose, nor does **onsemi** assume any liability arising out of the application or use of any product or circuit, and specifically disclaims any and all liability, including without limitation special, consequential or incidental damages. **onsemi** does not convey any license under its patent rights nor the rights of others.



SCALE 2:1

SC-74
CASE 318F
ISSUE P

DATE 07 OCT 2021

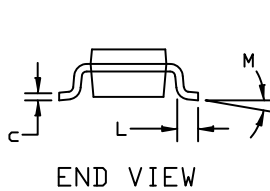
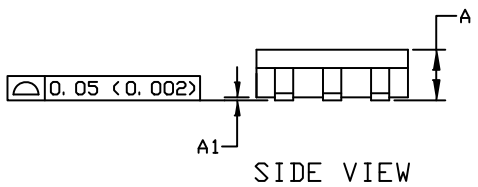
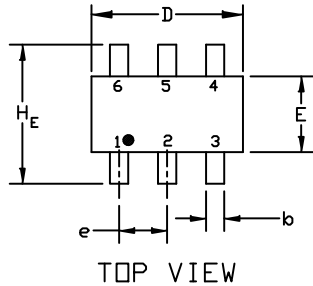

GENERIC
MARKING DIAGRAM*

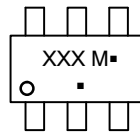

XXX = Specific Device Code
M = Date Code
▪ = Pb-Free Package

(Note: Microdot may be in either location)

*This information is generic. Please refer to device data sheet for actual part marking. Pb-Free indicator, "G" or microdot "▪", may or may not be present. Some products may not follow the Generic Marking.

NOTES:

1. DIMENSIONING AND TOLERANCING PER ASME Y14.5M, 1994
2. CONTROLLING DIMENSION: INCHES
3. MAXIMUM LEAD THICKNESS INCLUDES LEAD FINISH THICKNESS. MINIMUM LEAD THICKNESS IS THE MINIMUM THICKNESS OF THE BASE MATERIAL.

DIM	MILLIMETERS			INCHES		
	MIN.	NOM.	MAX.	MIN.	NOM.	MAX.
A	0.90	1.00	1.10	0.035	0.039	0.043
A1	0.01	0.06	0.10	0.001	0.002	0.004
b	0.25	0.37	0.50	0.010	0.015	0.020
c	0.10	0.18	0.26	0.004	0.007	0.010
D	2.90	3.00	3.10	0.114	0.118	0.122
E	1.30	1.50	1.70	0.051	0.059	0.067
e	0.85	0.95	1.05	0.034	0.037	0.041
HE	2.50	2.75	3.00	0.099	0.108	0.118
L	0.20	0.40	0.60	0.008	0.016	0.024
M	0*	---	10*	0*	---	10*

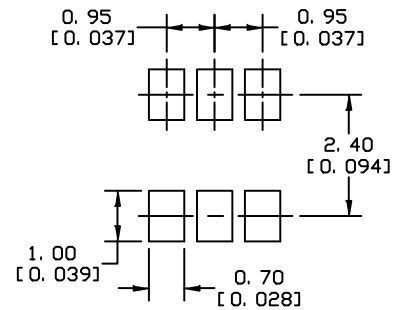

* For additional information on our Pb-Free strategy and soldering details, please download the DN Semiconductor Soldering and Mounting Techniques Reference Manual, SOLDERM/D.

SOLDERING FOOTPRINT

<p>STYLE 1: PIN 1. CATHODE 2. ANODE 3. CATHODE 4. CATHODE 5. ANODE 6. CATHODE</p>	<p>STYLE 2: PIN 1. NO CONNECTION 2. COLLECTOR 3. EMITTER 4. NO CONNECTION 5. COLLECTOR 6. BASE</p>	<p>STYLE 3: PIN 1. EMITTER 1 2. BASE 1 3. COLLECTOR 2 4. EMITTER 2 5. BASE 2 6. COLLECTOR 1</p>	<p>STYLE 4: PIN 1. COLLECTOR 2 2. EMITTER 1/EMITTER 2 3. COLLECTOR 1 4. EMITTER 3 5. BASE 1/BASE 2/COLLECTOR 3 6. BASE 3</p>	<p>STYLE 5: PIN 1. CHANNEL 1 2. ANODE 3. CHANNEL 2 4. CHANNEL 3 5. CATHODE 6. CHANNEL 4</p>	<p>STYLE 6: PIN 1. CATHODE 2. ANODE 3. CATHODE 4. CATHODE 5. CATHODE 6. CATHODE</p>
<p>STYLE 7: PIN 1. SOURCE 1 2. GATE 1 3. DRAIN 2 4. SOURCE 2 5. GATE 2 6. DRAIN 1</p>	<p>STYLE 8: PIN 1. EMITTER 1 2. BASE 2 3. COLLECTOR 2 4. EMITTER 2 5. BASE 1 6. COLLECTOR 1</p>	<p>STYLE 9: PIN 1. EMITTER 2 2. BASE 2 3. COLLECTOR 1 4. EMITTER 1 5. BASE 1 6. COLLECTOR 2</p>	<p>STYLE 10: PIN 1. ANODE/CATHODE 2. BASE 3. EMITTER 4. COLLECTOR 5. ANODE 6. CATHODE</p>	<p>STYLE 11: PIN 1. EMITTER 2. BASE 3. ANODE/CATHODE 4. ANODE 5. CATHODE 6. COLLECTOR</p>	

DOCUMENT NUMBER:	98ASB42973B	Electronic versions are uncontrolled except when accessed directly from the Document Repository. Printed versions are uncontrolled except when stamped "CONTROLLED COPY" in red.
DESCRIPTION:	SC-74	PAGE 1 OF 1

onsemi and ONSEMI are trademarks of Semiconductor Components Industries, LLC dba onsemi or its subsidiaries in the United States and/or other countries. onsemi reserves the right to make changes without further notice to any products herein. onsemi makes no warranty, representation or guarantee regarding the suitability of its products for any particular purpose, nor does onsemi assume any liability arising out of the application or use of any product or circuit, and specifically disclaims any and all liability, including without limitation special, consequential or incidental damages. onsemi does not convey any license under its patent rights nor the rights of others.

onsemi, **Onsemi**, and other names, marks, and brands are registered and/or common law trademarks of Semiconductor Components Industries, LLC dba "**onsemi**" or its affiliates and/or subsidiaries in the United States and/or other countries. **onsemi** owns the rights to a number of patents, trademarks, copyrights, trade secrets, and other intellectual property. A listing of **onsemi**'s product/patent coverage may be accessed at www.onsemi.com/site/pdf/Patent-Marking.pdf. **onsemi** reserves the right to make changes at any time to any products or information herein, without notice. The information herein is provided "as-is" and **onsemi** makes no warranty, representation or guarantee regarding the accuracy of the information, product features, availability, functionality, or suitability of its products for any particular purpose, nor does **onsemi** assume any liability arising out of the application or use of any product or circuit, and specifically disclaims any and all liability, including without limitation special, consequential or incidental damages. Buyer is responsible for its products and applications using **onsemi** products, including compliance with all laws, regulations and safety requirements or standards, regardless of any support or applications information provided by **onsemi**. "Typical" parameters which may be provided in **onsemi** data sheets and/or specifications can and do vary in different applications and actual performance may vary over time. All operating parameters, including "Typicals" must be validated for each customer application by customer's technical experts. **onsemi** does not convey any license under any of its intellectual property rights nor the rights of others. **onsemi** products are not designed, intended, or authorized for use as a critical component in life support systems or any FDA Class 3 medical devices or medical devices with a same or similar classification in a foreign jurisdiction or any devices intended for implantation in the human body. Should Buyer purchase or use **onsemi** products for any such unintended or unauthorized application, Buyer shall indemnify and hold **onsemi** and its officers, employees, subsidiaries, affiliates, and distributors harmless against all claims, costs, damages, and expenses, and reasonable attorney fees arising out of, directly or indirectly, any claim of personal injury or death associated with such unintended or unauthorized use, even if such claim alleges that **onsemi** was negligent regarding the design or manufacture of the part. **onsemi** is an Equal Opportunity/Affirmative Action Employer. This literature is subject to all applicable copyright laws and is not for resale in any manner.

ADDITIONAL INFORMATION

TECHNICAL PUBLICATIONS:

Technical Library: www.onsemi.com/design/resources/technical-documentation
onsemi Website: www.onsemi.com

ONLINE SUPPORT: www.onsemi.com/support

For additional information, please contact your local Sales Representative at www.onsemi.com/support/sales