

NTUD3128N

Small Signal MOSFET

20 V, 200 mA, Dual N-Channel, 1.0 mm x 1.0 mm SOT-963 Package



ON Semiconductor®

<http://onsemi.com>

Features

- Dual N-Channel MOSFET
- Offers a Low $R_{DS(ON)}$ Solution in the Ultra Small 1.0 x 1.0 mm Package
- 1.5 V Gate Voltage Rating
- Ultra Thin Profile (< 0.5 mm) Allows It to Fit Easily into Extremely Thin Environments such as Portable Electronics
- These are Pb-Free Devices

Applications

- General Purpose Interfacing Switch
- Optimized for Power Management in Ultra Portable Equipment

MAXIMUM RATINGS ($T_J = 25^\circ\text{C}$ unless otherwise specified)

Parameter		Symbol	Value	Unit
Drain-to-Source Voltage		V_{DSS}	20	V
Gate-to-Source Voltage		V_{GS}	± 8	V
Continuous Drain Current (Note 1)	Steady State	$T_A = 25^\circ\text{C}$	I_D	160
				$T_A = 85^\circ\text{C}$
	$t \leq 5 \text{ s}$	$T_A = 25^\circ\text{C}$		200
Power Dissipation (Note 1)	Steady State	$T_A = 25^\circ\text{C}$	P_D	125
				$t \leq 5 \text{ s}$
Pulsed Drain Current		$t_p = 10 \mu\text{s}$	I_{DM}	800
Operating Junction and Storage Temperature		T_J, T_{STG}	-55 to 150	$^\circ\text{C}$
Source Current (Body Diode) (Note 2)		I_S	200	mA
Lead Temperature for Soldering Purposes (1/8" from case for 10 s)		T_L	260	$^\circ\text{C}$

Stresses exceeding Maximum Ratings may damage the device. Maximum Ratings are stress ratings only. Functional operation above the Recommended Operating Conditions is not implied. Extended exposure to stresses above the Recommended Operating Conditions may affect device reliability.

1. Surface-mounted on FR4 board using the minimum recommended pad size, 1 oz Cu.
2. Pulse Test: pulse width $\leq 300 \mu\text{s}$, duty cycle $\leq 2\%$

$V_{(BR)DSS}$	$R_{DS(ON)} \text{ MAX}$	$I_D \text{ Max}$
20 V	3.0 Ω @ 4.5 V	0.2 A
	4.0 Ω @ 2.5 V	
	6.0 Ω @ 1.8 V	
	10 Ω @ 1.5 V	

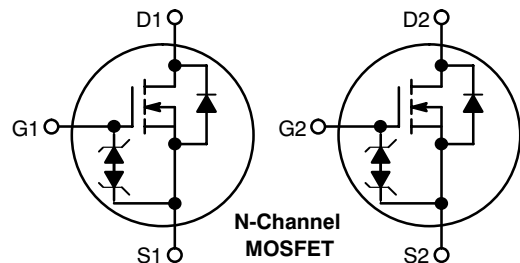

PINOUT: SOT-963

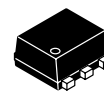
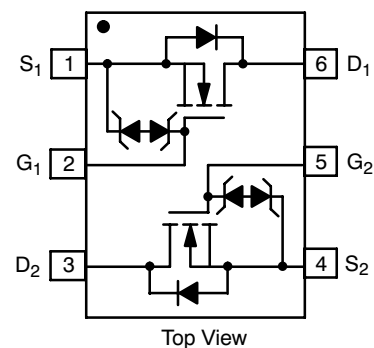

SOT-963
CASE 527AA

MARKING DIAGRAM

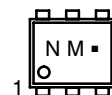

- N = Specific Device Code
- M = Date Code
- = Pb-Free Package

ORDERING INFORMATION

See detailed ordering and shipping information in the package dimensions section on page 4 of this data sheet.

NTUD3128N

THERMAL RESISTANCE RATINGS

Parameter	Symbol	Max	Unit
Junction-to-Ambient – Steady State (Note 3)	$R_{\theta JA}$	1000	$^{\circ}\text{C}/\text{W}$
Junction-to-Ambient – $t = 5$ s (Note 3)		600	

3. Surface-mounted on FR4 board using the minimum recommended pad size, 1 oz Cu.

ELECTRICAL CHARACTERISTICS ($T_J = 25^{\circ}\text{C}$ unless otherwise specified)

Parameter	Symbol	Test Condition	Min	Typ	Max	Unit
OFF CHARACTERISTICS						
Drain-to-Source Breakdown Voltage	$V_{(BR)DSS}$	$V_{GS} = 0\text{ V}, I_D = 250\ \mu\text{A}$	20			V
Zero Gate Voltage Drain Current	I_{DSS}	$V_{GS} = 0\text{ V}, V_{DS} = 5\text{ V}$	$T_J = 25^{\circ}\text{C}$		50	nA
			$T_J = 85^{\circ}\text{C}$		200	
		$V_{GS} = 0\text{ V}, V_{DS} = 16\text{ V}$	$T_J = 25^{\circ}\text{C}$		100	
Gate-to-Source Leakage Current	I_{GSS}	$V_{DS} = 0\text{ V}, V_{GS} = \pm 5.0\text{ V}$			100	nA

ON CHARACTERISTICS (Note 4)

Gate Threshold Voltage	$V_{GS(TH)}$	$V_{GS} = V_{DS}, I_D = 250\ \mu\text{A}$	0.4		1.0	V
Drain-to-Source On Resistance	$R_{DS(ON)}$	$V_{GS} = 4.5\text{ V}, I_D = 100\text{ mA}$		1.5	3.0	Ω
		$V_{GS} = 2.5\text{ V}, I_D = 50\text{ mA}$		2.0	4.0	
		$V_{GS} = 1.8\text{ V}, I_D = 20\text{ mA}$		3.0	6.0	
		$V_{GS} = 1.5\text{ V}, I_D = 10\text{ mA}$		4.0	10	
		$V_{GS} = 1.2\text{ V}, I_D = 1.0\text{ mA}$		5.5		
Forward Transconductance	g_{FS}	$V_{DS} = 5.0\text{ V}, I_D = 125\text{ mA}$		0.35		S
Source-Drain Diode Voltage	V_{SD}	$V_{GS} = 0\text{ V}, I_D = 10\text{ mA}$		0.6	1.0	V

CHARGES, CAPACITANCES AND GATE RESISTANCE

Input Capacitance	C_{ISS}	$f = 1.0\text{ MHz}, V_{GS} = 0\text{ V}$ $V_{DS} = 15\text{ V}$		9.0		pF
Output Capacitance	C_{OSS}			3.0		
Reverse Transfer Capacitance	C_{RSS}			2.2		

SWITCHING CHARACTERISTICS, $V_{GS} = 4.5\text{ V}$ (Note 4)

Turn-On Delay Time	$t_{d(ON)}$	$V_{GS} = 4.5\text{ V}, V_{DD} = 10\text{ V}, I_D = 200\text{ mA},$ $R_G = 2.0\ \Omega$		15		ns
Rise Time	t_r			24		
Turn-Off Delay Time	$t_{d(OFF)}$			90		
Fall Time	t_f			60		

4. Switching characteristics are independent of operating junction temperatures.

TYPICAL PERFORMANCE CURVES

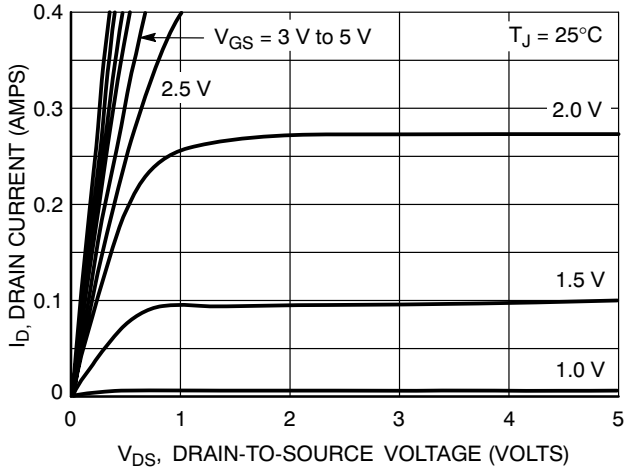

Figure 1. On-Region Characteristics

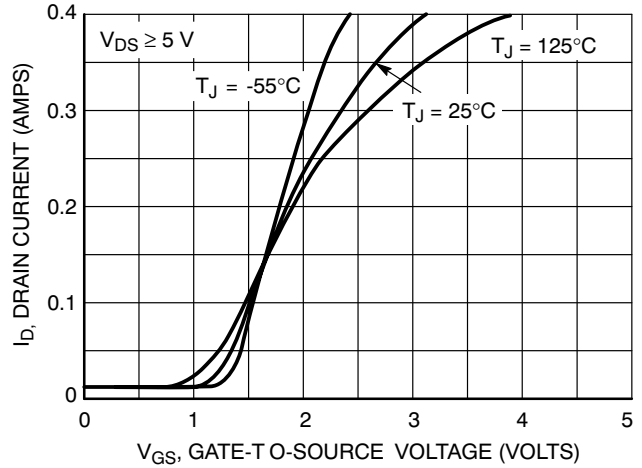

Figure 2. Transfer Characteristics

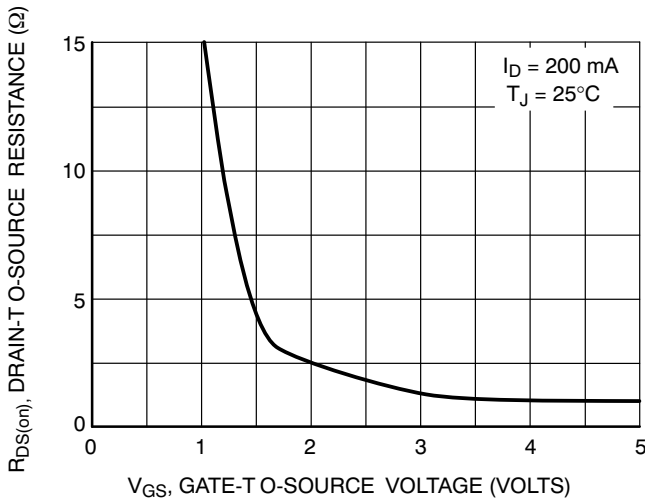

Figure 3. On-Resistance vs. Gate Voltage

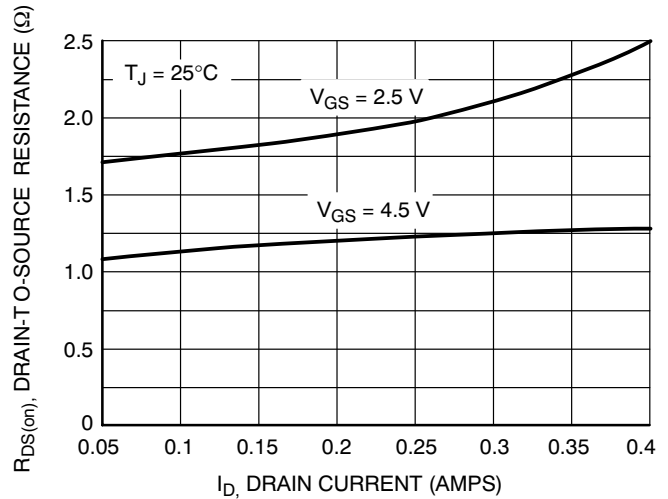

Figure 4. On-Resistance vs. Drain Current and Gate Voltage

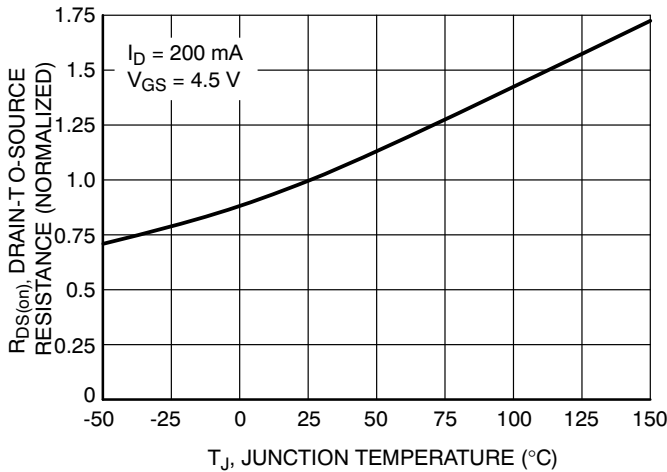

Figure 5. On-Resistance Variation with Temperature

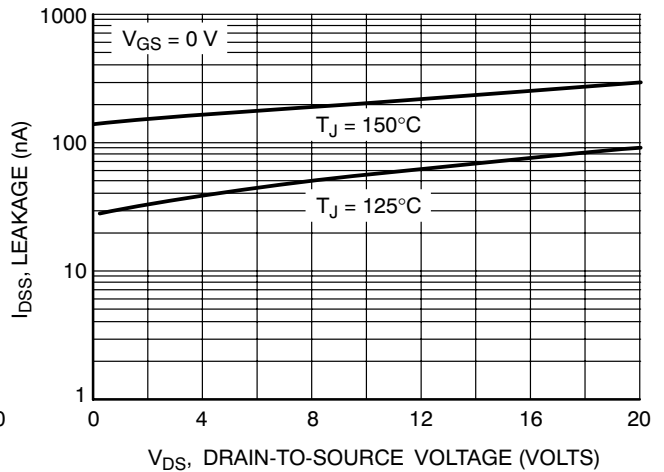

Figure 6. Drain-to-Source Leakage Current vs. Voltage

NTUD3128N

TYPICAL PERFORMANCE CURVES

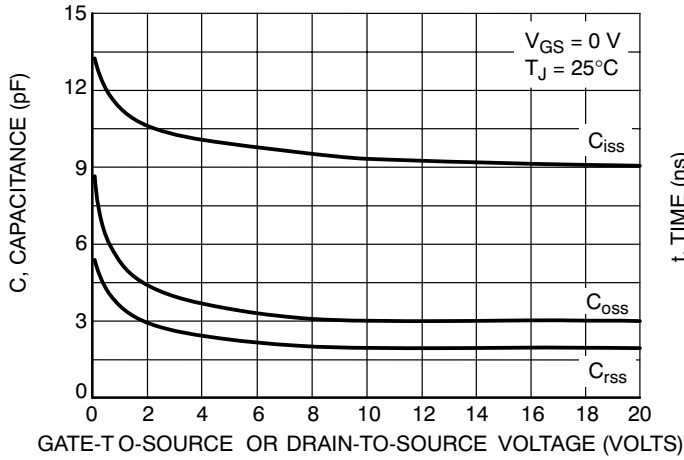

Figure 7. Capacitance Variation

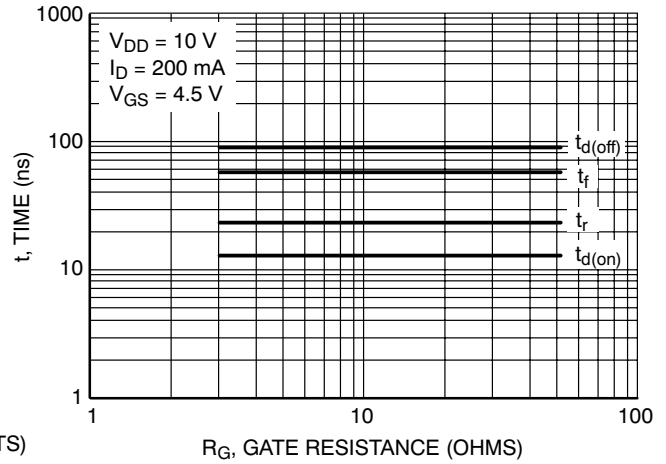

Figure 8. Resistive Switching Time Variation vs. Gate Resistance

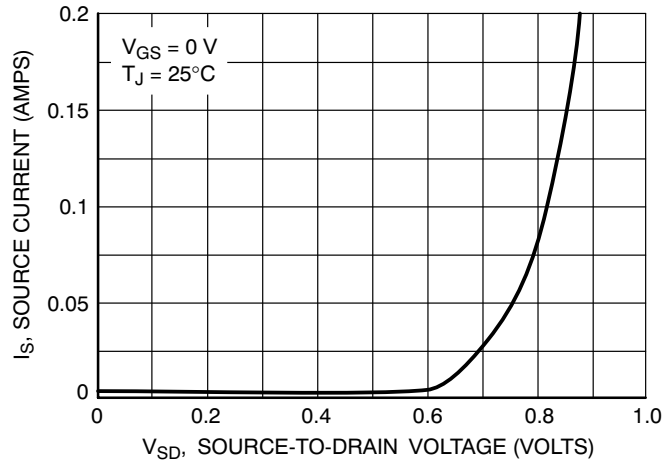

Figure 9. Diode Forward Voltage vs. Current

ORDERING INFORMATION

Device	Package	Shipping [†]
NTUD3128NT5G	SOT-963 (Pb-Free)	8000 / Tape & Reel

[†]For information on tape and reel specifications, including part orientation and tape sizes, please refer to our Tape and Reel Packaging Specifications Brochure, BRD8011/D.

MECHANICAL CASE OUTLINE PACKAGE DIMENSIONS

ON Semiconductor®



SOT-963
CASE 527AA-01
ISSUE D

DATE 30 JUL 2008

SCALE 4:1

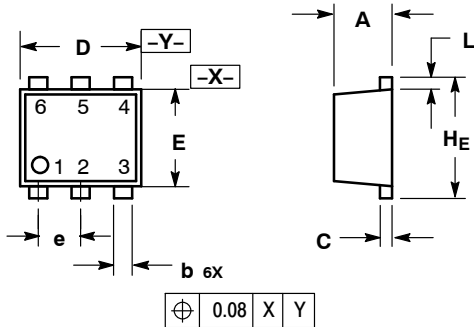

NOTES:

1. DIMENSIONING AND TOLERANCING PER ANSI Y14.5M, 1982.
2. CONTROLLING DIMENSION: MILLIMETERS
3. MAXIMUM LEAD THICKNESS INCLUDES LEAD FINISH THICKNESS. MINIMUM LEAD THICKNESS IS THE MINIMUM THICKNESS OF BASE MATERIAL

DIM	MILLIMETERS			INCHES		
	MIN	NOM	MAX	MIN	NOM	MAX
A	0.40	0.45	0.50	0.016	0.018	0.020
b	0.10	0.15	0.20	0.004	0.006	0.008
C	0.05	0.10	0.15	0.002	0.004	0.006
D	0.95	1.00	1.05	0.037	0.039	0.041
E	0.75	0.80	0.85	0.03	0.032	0.034
e	0.35 BSC			0.014 BSC		
L	0.05	0.10	0.15	0.002	0.004	0.006
H _E	0.95	1.00	1.05	0.037	0.039	0.041

- | | | |
|--|---|--|
| <p>STYLE 1:
PIN 1. EMITTER 1
2. BASE 1
3. COLLECTOR 2
4. EMITTER 2
5. BASE 2
6. COLLECTOR 1</p> | <p>STYLE 2:
PIN 1. EMITTER 1
2. EMITTER2
3. BASE 2
4. COLLECTOR 2
5. BASE 1
6. COLLECTOR 1</p> | <p>STYLE 3:
PIN 1. CATHODE 1
2. CATHODE 1
3. ANODE/ANODE 2
4. CATHODE 2
5. CATHODE 2
6. ANODE/ANODE 1</p> |
| <p>STYLE 4:
PIN 1. COLLECTOR
2. COLLECTOR
3. BASE
4. EMITTER
5. COLLECTOR
6. COLLECTOR</p> | <p>STYLE 5:
PIN 1. CATHODE
2. CATHODE
3. ANODE
4. ANODE
5. CATHODE
6. CATHODE</p> | <p>STYLE 6:
PIN 1. CATHODE
2. ANODE
3. CATHODE
4. CATHODE
5. CATHODE
6. CATHODE</p> |
| <p>STYLE 7:
PIN 1. CATHODE
2. ANODE
3. CATHODE
4. CATHODE
5. ANODE
6. CATHODE</p> | <p>STYLE 8:
PIN 1. DRAIN
2. DRAIN
3. GATE
4. SOURCE
5. DRAIN
6. DRAIN</p> | <p>STYLE 9:
PIN 1. SOURCE 1
2. GATE 1
3. DRAIN 2
4. SOURCE 2
5. GATE 2
6. DRAIN 1</p> |
| <p>STYLE 10:
PIN 1. CATHODE 1
2. N/C
3. CATHODE 2
4. ANODE 2
5. N/C
6. ANODE 1</p> | | |

GENERIC MARKING DIAGRAM*

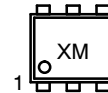

X = Specific Device Code
M = Month Code

*This information is generic. Please refer to device data sheet for actual part marking.

Pb-Free indicator, "G" or microdot "▪", may or may not be present.

SOLDERING FOOTPRINT*

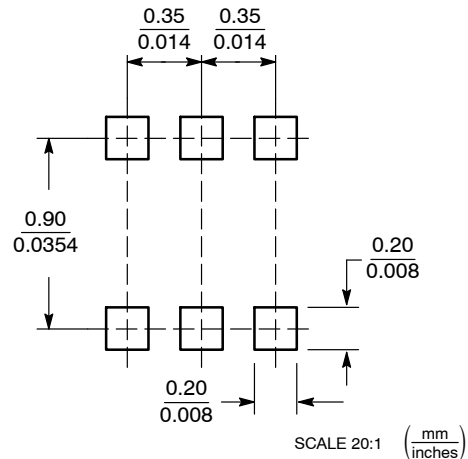

*For additional information on our Pb-Free strategy and soldering details, please download the ON Semiconductor Soldering and Mounting Techniques Reference Manual, SOLDERRM/D.

DOCUMENT NUMBER:	98AON18698D	Electronic versions are uncontrolled except when accessed directly from the Document Repository. Printed versions are uncontrolled except when stamped "CONTROLLED COPY" in red.
DESCRIPTION:	SOT-963, 1X1, 0.35P	PAGE 1 OF 1

ON Semiconductor and are trademarks of Semiconductor Components Industries, LLC dba ON Semiconductor or its subsidiaries in the United States and/or other countries. ON Semiconductor reserves the right to make changes without further notice to any products herein. ON Semiconductor makes no warranty, representation or guarantee regarding the suitability of its products for any particular purpose, nor does ON Semiconductor assume any liability arising out of the application or use of any product or circuit, and specifically disclaims any and all liability, including without limitation special, consequential or incidental damages. ON Semiconductor does not convey any license under its patent rights nor the rights of others.

onsemi, **Onsemi**, and other names, marks, and brands are registered and/or common law trademarks of Semiconductor Components Industries, LLC dba "**onsemi**" or its affiliates and/or subsidiaries in the United States and/or other countries. **onsemi** owns the rights to a number of patents, trademarks, copyrights, trade secrets, and other intellectual property. A listing of **onsemi**'s product/patent coverage may be accessed at www.onsemi.com/site/pdf/Patent-Marking.pdf. **onsemi** reserves the right to make changes at any time to any products or information herein, without notice. The information herein is provided "as-is" and **onsemi** makes no warranty, representation or guarantee regarding the accuracy of the information, product features, availability, functionality, or suitability of its products for any particular purpose, nor does **onsemi** assume any liability arising out of the application or use of any product or circuit, and specifically disclaims any and all liability, including without limitation special, consequential or incidental damages. Buyer is responsible for its products and applications using **onsemi** products, including compliance with all laws, regulations and safety requirements or standards, regardless of any support or applications information provided by **onsemi**. "Typical" parameters which may be provided in **onsemi** data sheets and/or specifications can and do vary in different applications and actual performance may vary over time. All operating parameters, including "Typicals" must be validated for each customer application by customer's technical experts. **onsemi** does not convey any license under any of its intellectual property rights nor the rights of others. **onsemi** products are not designed, intended, or authorized for use as a critical component in life support systems or any FDA Class 3 medical devices or medical devices with a same or similar classification in a foreign jurisdiction or any devices intended for implantation in the human body. Should Buyer purchase or use **onsemi** products for any such unintended or unauthorized application, Buyer shall indemnify and hold **onsemi** and its officers, employees, subsidiaries, affiliates, and distributors harmless against all claims, costs, damages, and expenses, and reasonable attorney fees arising out of, directly or indirectly, any claim of personal injury or death associated with such unintended or unauthorized use, even if such claim alleges that **onsemi** was negligent regarding the design or manufacture of the part. **onsemi** is an Equal Opportunity/Affirmative Action Employer. This literature is subject to all applicable copyright laws and is not for resale in any manner.

ADDITIONAL INFORMATION

TECHNICAL PUBLICATIONS:

Technical Library: www.onsemi.com/design/resources/technical-documentation
onsemi Website: www.onsemi.com

ONLINE SUPPORT: www.onsemi.com/support

For additional information, please contact your local Sales Representative at www.onsemi.com/support/sales