

MOSFET – Power, Single N-Channel, Logic Level, SO8FL

40 V, 0.7 mΩ, 349 A

NTMFS0D7N04XL

Features

- Low $R_{DS(on)}$ to Minimize Conduction Loss
- Low Q_{RR} with Soft Recovery to Minimize E_{RR} Loss and Voltage Spike
- Low Q_G and Capacitance to Minimize Driving and Switching Loss
- These Devices are Pb-Free, Halogen Free/BFR Free and are RoHS Compliant

Typical Applications

- High Switching Frequency DC-DC Conversion
- Synchronous Rectification

MAXIMUM RATINGS ($T_J = 25^\circ\text{C}$ unless otherwise stated)

Parameter	Symbol	Value	Unit
Drain-to-Source Voltage	V_{DSS}	40	V
Gate-to-Source Voltage	DC V_{GS}	± 20	V
Continuous Drain Current (Note 2)	I_D	$T_C = 25^\circ\text{C}$	349
		$T_C = 100^\circ\text{C}$	247
Power Dissipation (Note 2)	P_D	$T_C = 25^\circ\text{C}$	167
		$T_C = 100^\circ\text{C}$	83
Pulsed Drain Current	$T_C = 25^\circ\text{C}, t_p = 100 \mu\text{s}$	I_{DM}	1667
Pulsed Source Current (Body Diode)		I_{SM}	1667
Operating Junction and Storage Temperature Range	T_J, T_{STG}	-55 to +175	$^\circ\text{C}$
Source Current (Body Diode)	I_S	256	A
Single Pulse Avalanche Energy ($I_{PK} = 97 \text{ A}$) (Note 3)	E_{AS}	470	mJ
Lead Temperature for Soldering Purposes (1/8" from case for 10 s)	T_L	260	$^\circ\text{C}$

Stresses exceeding those listed in the Maximum Ratings table may damage the device. If any of these limits are exceeded, device functionality should not be assumed, damage may occur and reliability may be affected.

1. Surface-mounted on FR4 board using 1 in² pad size, 1 oz Cu pad.
2. The entire application environment impacts the thermal resistance values shown, they are not constants and are only valid for the particular conditions noted.
3. E_{AS} of 470 mJ is based on started $T_J = 25^\circ\text{C}$, $I_{AS} = 97 \text{ A}$, $V_{DD} = 32 \text{ V}$, $V_{GS} = 10 \text{ V}$, 100% avalanche tested.

$V_{(BR)DSS}$	$R_{DS(ON)} \text{ MAX}$	$I_D \text{ MAX}$
40 V	0.7 mΩ @ 10 V	349 A
	1.1 mΩ @ 4.5 V	

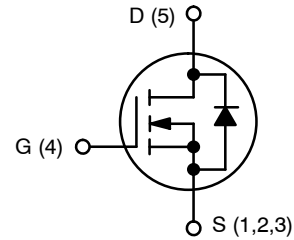

N-CHANNEL MOSFET

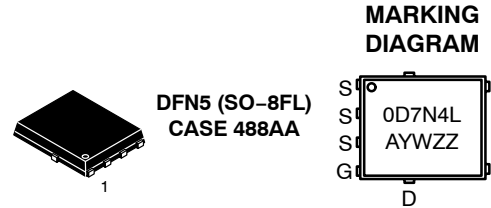

0D7N4L = Specific Device Code
 A = Assembly Location
 Y = Year
 W = Work Week
 ZZ = Lot Traceability

ORDERING INFORMATION

See detailed ordering, marking and shipping information on page 6 of this data sheet.

NTMFS0D7N04XL

THERMAL CHARACTERISTICS

Parameter	Symbol	Value	Unit
Thermal Resistance, Junction-to-Case	$R_{\theta JC}$	0.9	°C/W
Thermal Resistance, Junction-to-Ambient	$R_{\theta JA}$	38	

ELECTRICAL CHARACTERISTICS ($T_J = 25^\circ\text{C}$ unless otherwise specified)

Parameter	Symbol	Test Conditions	Min	Typ	Max	Unit
OFF CHARACTERISTICS						
Drain-to-Source Breakdown Voltage	$V_{(BR)DSS}$	$V_{GS} = 0\text{ V}, I_D = 1\text{ mA}$	40			V
Drain-to-Source Breakdown Voltage Temperature Coefficient	$\Delta V_{(BR)DSS} / \Delta T_J$	$I_D = 1\text{ mA}$, Referenced to 25°C		16.6		mV/°C
Zero Gate Voltage Drain Current	I_{DSS}	$V_{DS} = 40\text{ V}, T_J = 25^\circ\text{C}$			1	μA
		$V_{DS} = 40\text{ V}, T_J = 125^\circ\text{C}$			60	
Gate-to-Source Leakage Current	I_{GSS}	$V_{GS} = 20\text{ V}, V_{DS} = 0\text{ V}$			100	nA

ON CHARACTERISTICS

Drain-to-Source On Resistance	$R_{DS(on)}$	$V_{GS} = 10\text{ V}, I_D = 49\text{ A}$		0.58	0.7	m Ω
		$V_{GS} = 6\text{ V}, I_D = 49\text{ A}$		0.66	0.9	
		$V_{GS} = 4.5\text{ V}, I_D = 39\text{ A}$		0.77	1.1	
Gate Threshold Voltage	$V_{GS(TH)}$	$V_{GS} = V_{DS}, I_D = 250\ \mu\text{A}$	1.3		2.2	V
Gate Threshold Voltage Temperature Coefficient	$\Delta V_{GS(TH)} / \Delta T_J$	$V_{GS} = V_{DS}, I_D = 250\ \mu\text{A}$		-5.35		mV/°C
Forward Transconductance	g_{FS}	$V_{DS} = 5\text{ V}, I_D = 49\text{ A}$		245		S

CHARGES, CAPACITANCES & GATE RESISTANCE

Input Capacitance	C_{ISS}	$V_{GS} = 0\text{ V}, V_{DS} = 20\text{ V}, f = 1\text{ MHz}$		7090		pF
Output Capacitance	C_{OSS}			1860		
Reverse Transfer Capacitance	C_{RSS}			40		
Output Charge	Q_{OSS}	$V_{GS} = 0\text{ V}, V_{DS} = 20\text{ V}$		72		nC
Total Gate Charge	$Q_{G(TOT)}$	$V_{GS} = 4.5\text{ V}, V_{DD} = 20\text{ V}; I_D = 49\text{ A}$		42		
		$V_{GS} = 6\text{ V}, V_{DD} = 20\text{ V}; I_D = 49\text{ A}$		57		
		$V_{GS} = 10\text{ V}, V_{DD} = 20\text{ V}; I_D = 49\text{ A}$		96		
Threshold Gate Charge	$Q_{G(TH)}$	$V_{GS} = 10\text{ V}, V_{DD} = 20\text{ V}; I_D = 49\text{ A}$		11		
Gate-to-Source Charge	Q_{GS}			20		
Gate-to-Drain Charge	Q_{GD}			6		
Gate Plateau Voltage	V_{GP}			2.89		V
Gate Resistance	R_G		$f = 1\text{ MHz}$		0.5	

SWITCHING CHARACTERISTICS

Turn-On Delay Time	$t_{d(ON)}$	Resistive Load, $V_{GS} = 0/10\text{ V}, V_{DD} = 20\text{ V},$ $I_D = 49\text{ A}, R_G = 2.5\ \Omega$		25		ns
Rise Time	t_r			7		
Turn-Off Delay Time	$t_{d(OFF)}$			64		
Fall Time	t_f			5		

SOURCE-TO-DRAIN DIODE CHARACTERISTICS

Forward Diode Voltage	V_{SD}	$V_{GS} = 0\text{ V}, I_S = 49\text{ A}, T_J = 25^\circ\text{C}$		0.8	1.2	V
		$V_{GS} = 0\text{ V}, I_S = 49\text{ A}, T_J = 125^\circ\text{C}$		0.65		

NTMFS0D7N04XL

ELECTRICAL CHARACTERISTICS (T_J = 25°C unless otherwise specified)

Parameter	Symbol	Test Conditions	Min	Typ	Max	Unit
SOURCE-TO-DRAIN DIODE CHARACTERISTICS						
Reverse Recovery Time	t _{RR}	V _{GS} = 0 V, dl/dt = 300 A/μs, I _S = 49 A, V _{DD} = 20 V		39		ns
Charge Time	t _a			21		
Discharge Time	t _b			18		
Reverse Recovery Charge	Q _{RR}			87		nC

Product parametric performance is indicated in the Electrical Characteristics for the listed test conditions, unless otherwise noted. Product performance may not be indicated by the Electrical Characteristics if operated under different conditions.

NTMFS0D7N04XL

TYPICAL CHARACTERISTICS

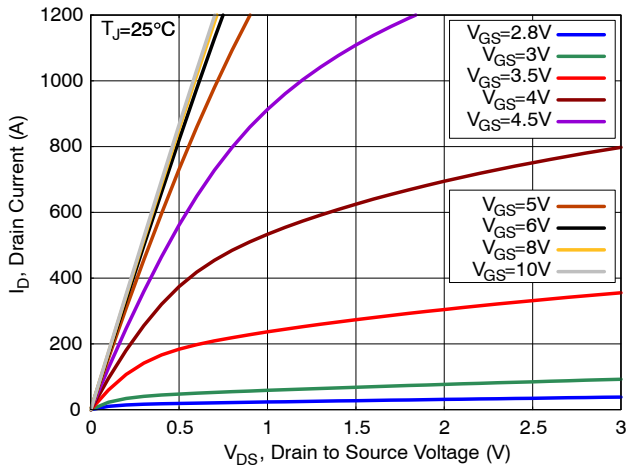

Figure 1. On-Region Characteristics

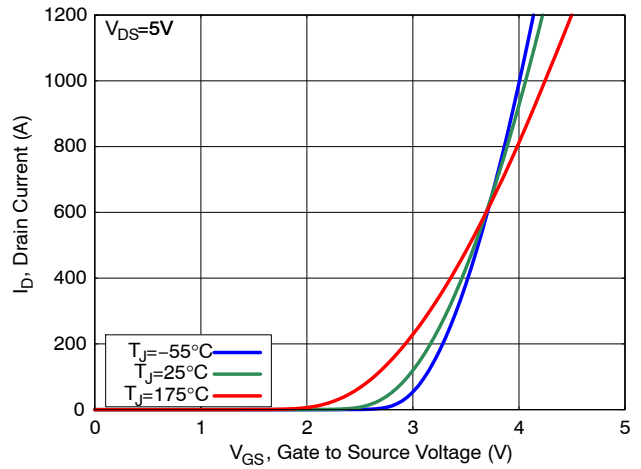

Figure 2. Transfer Characteristics

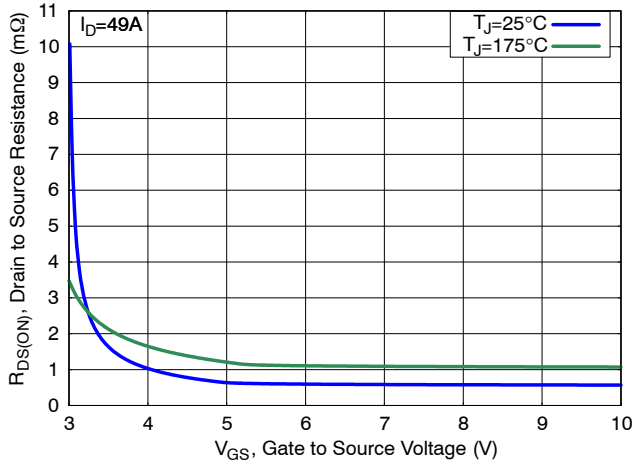

Figure 3. On-Resistance vs. Gate Voltage

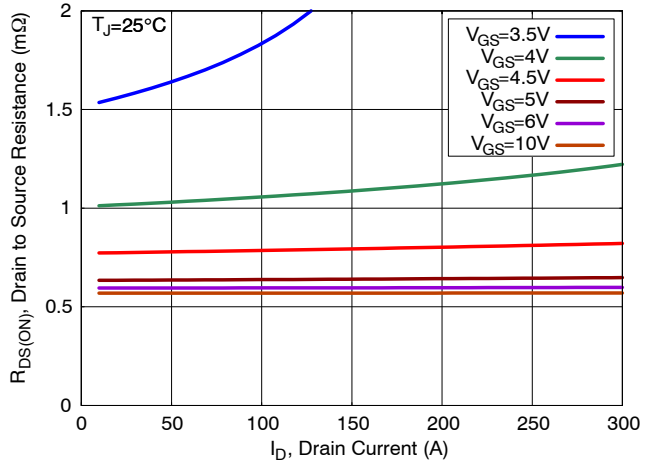

Figure 4. On-Resistance vs. Drain Current

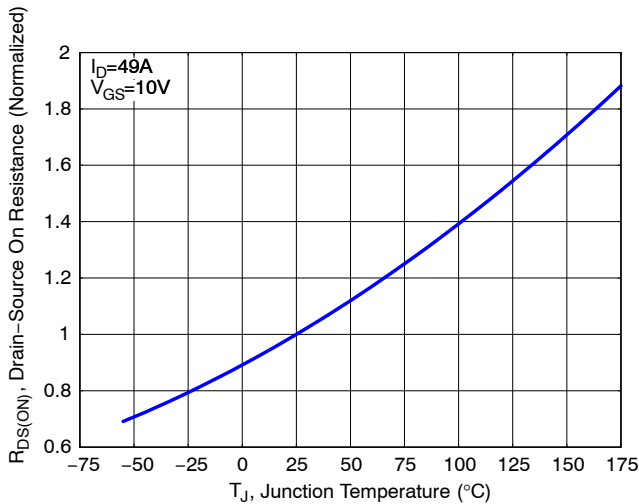

Figure 5. Normalized ON Resistance vs. Junction Temperature

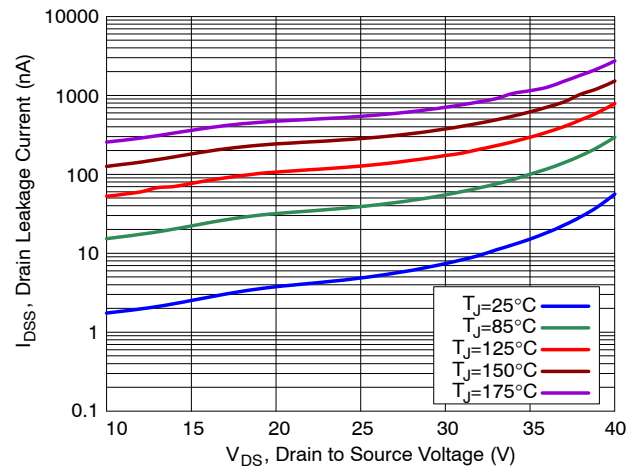

Figure 6. Drain Leakage Current vs. Drain Voltage

NTMFS0D7N04XL

TYPICAL CHARACTERISTICS (CONTINUED)

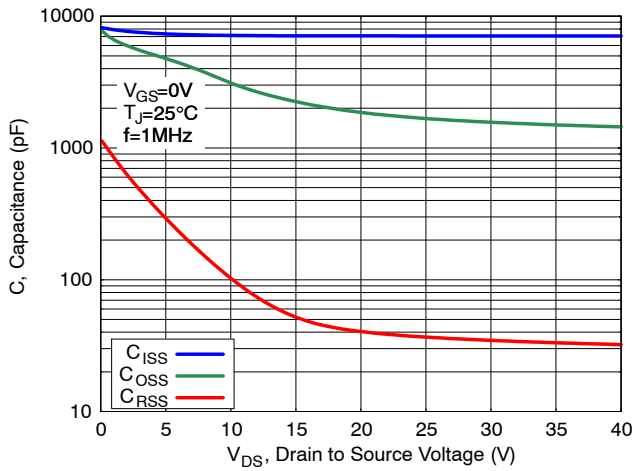

Figure 7. Capacitance Characteristics

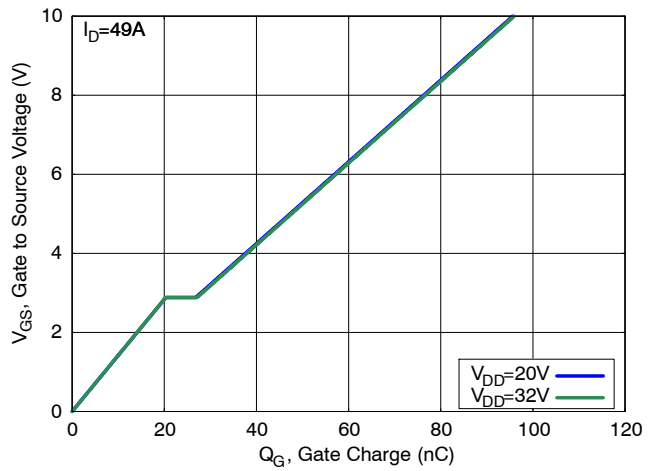

Figure 8. Gate Charge Characteristics

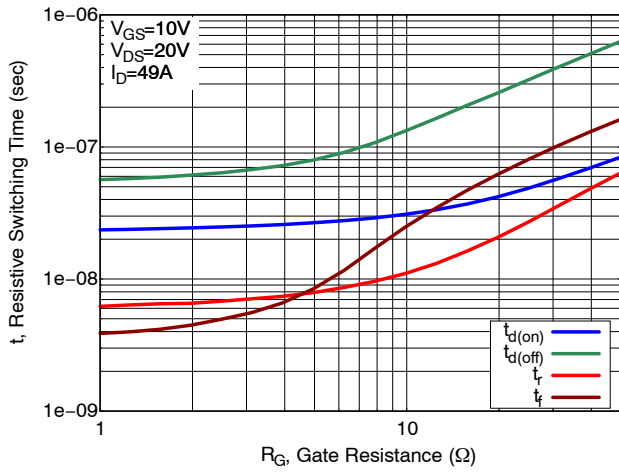

Figure 9. Resistive Switching Time Variation vs. Gate Resistance

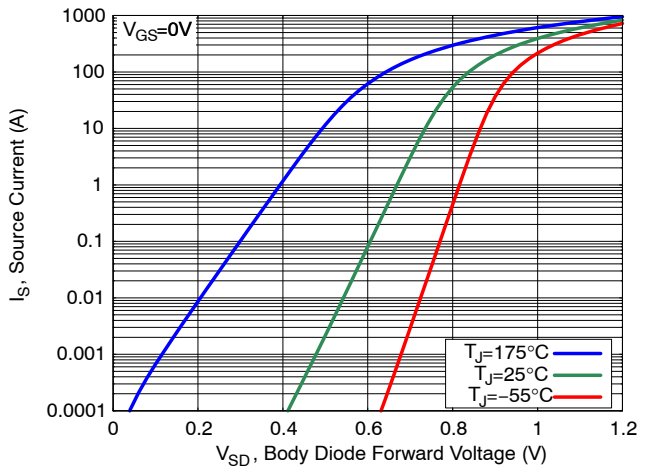

Figure 10. Diode Forward Characteristics

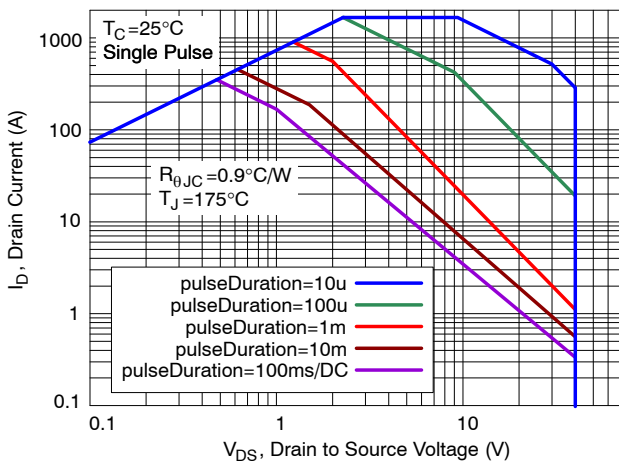

Figure 11. Safe Operating Area (SOA)

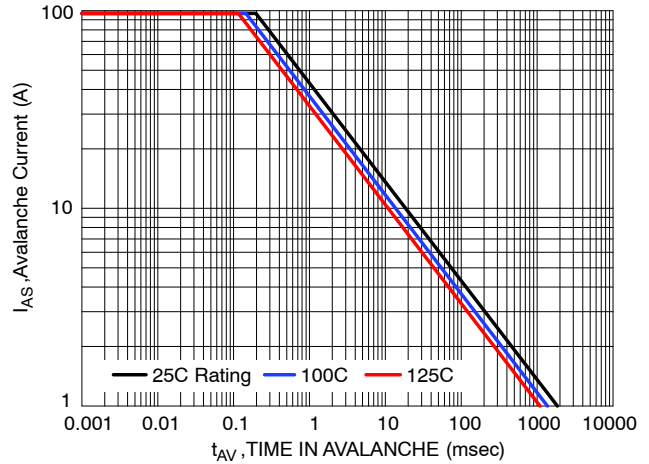

Figure 12. Avalanche Current vs. Pulse Time (UIS)

NTMFS0D7N04XL

TYPICAL CHARACTERISTICS (CONTINUED)

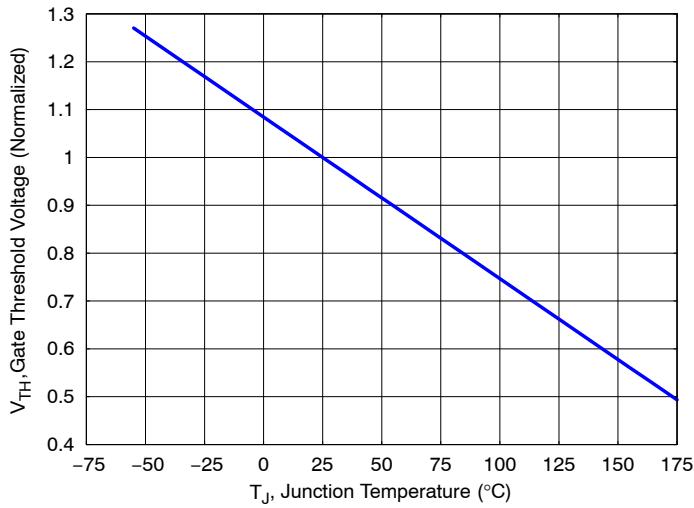

Figure 13. Gate Threshold Voltage vs. Junction Temperature

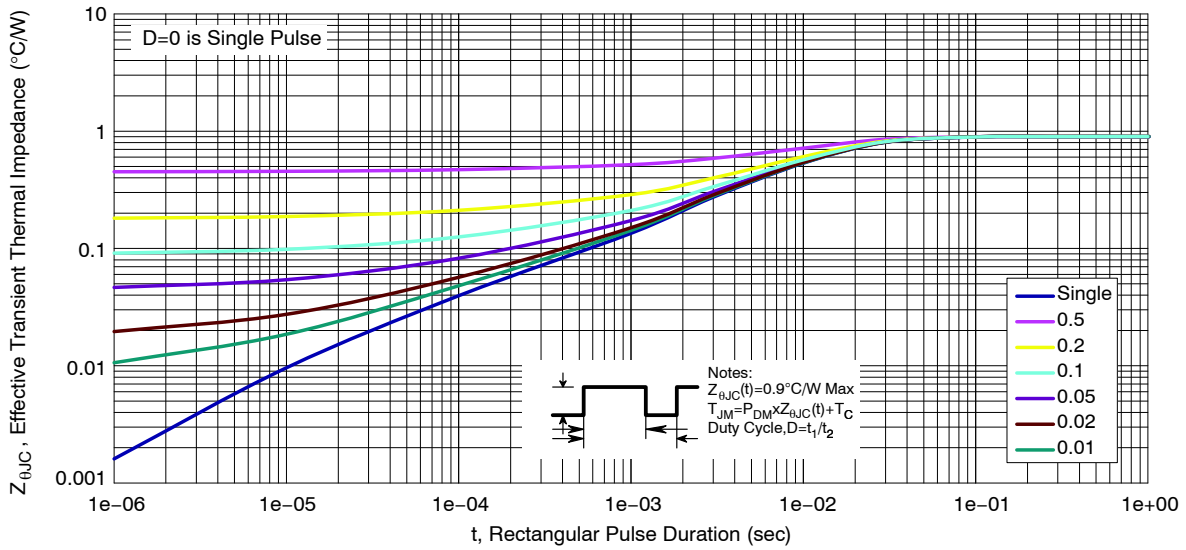

Figure 14. Thermal Characteristics

DEVICE ORDERING INFORMATION

Device	Marking	Package	Shipping [†]
NTMFS0D7N04XLT1G	0D7N4L	DFN5 (Pb-Free)	1500 / Tape & Reel

[†]For information on tape and reel specifications, including part orientation and tape sizes, please refer to our Tape and Reel Packaging Specifications Brochure, BRD8011/D.

MECHANICAL CASE OUTLINE

PACKAGE DIMENSIONS



1
SCALE 2:1

DFN5 5x6, 1.27P
(SO-8FL)
CASE 488AA
ISSUE N

DATE 25 JUN 2018



NOTES:

1. DIMENSIONING AND TOLERANCING PER ASME Y14.5M, 1994.
2. CONTROLLING DIMENSION: MILLIMETER.
3. DIMENSION D1 AND E1 DO NOT INCLUDE MOLD FLASH PROTRUSIONS OR GATE BURRS.

DIM	MILLIMETERS		
	MIN	NOM	MAX
A	0.90	1.00	1.10
A1	0.00	---	0.05
b	0.33	0.41	0.51
c	0.23	0.28	0.33
D	5.00	5.15	5.30
D1	4.70	4.90	5.10
D2	3.80	4.00	4.20
E	6.00	6.15	6.30
E1	5.70	5.90	6.10
E2	3.45	3.65	3.85
e	1.27 BSC		
G	0.51	0.575	0.71
K	1.20	1.35	1.50
L	0.51	0.575	0.71
L1	0.125 REF		
M	3.00	3.40	3.80
θ	0°	---	12°

GENERIC MARKING DIAGRAM*



- XXXXXX = Specific Device Code
- A = Assembly Location
- Y = Year
- W = Work Week
- ZZ = Lot Traceability

*This information is generic. Please refer to device data sheet for actual part marking. Pb-Free indicator, "G" or microdot "•", may or may not be present. Some products may not follow the Generic Marking.



- STYLE 1:
PIN 1. SOURCE
2. SOURCE
3. SOURCE
4. GATE
5. DRAIN
- STYLE 2:
PIN 1. ANODE
2. ANODE
3. ANODE
4. NO CONNECT
5. CATHODE

DIMENSIONS: MILLIMETERS

*For additional information on our Pb-Free strategy and soldering details, please download the ON Semiconductor Soldering and Mounting Techniques Reference Manual, SOLDERRM/D.

DOCUMENT NUMBER:	98AON14036D	Electronic versions are uncontrolled except when accessed directly from the Document Repository. Printed versions are uncontrolled except when stamped "CONTROLLED COPY" in red.
DESCRIPTION:	DFN5 5x6, 1.27P (SO-8FL)	PAGE 1 OF 1

onsemi and ONSEMI are trademarks of Semiconductor Components Industries, LLC dba onsemi or its subsidiaries in the United States and/or other countries. onsemi reserves the right to make changes without further notice to any products herein. onsemi makes no warranty, representation or guarantee regarding the suitability of its products for any particular purpose, nor does onsemi assume any liability arising out of the application or use of any product or circuit, and specifically disclaims any and all liability, including without limitation special, consequential or incidental damages. onsemi does not convey any license under its patent rights nor the rights of others.

onsemi, **Onsemi**, and other names, marks, and brands are registered and/or common law trademarks of Semiconductor Components Industries, LLC dba "**onsemi**" or its affiliates and/or subsidiaries in the United States and/or other countries. **onsemi** owns the rights to a number of patents, trademarks, copyrights, trade secrets, and other intellectual property. A listing of **onsemi**'s product/patent coverage may be accessed at www.onsemi.com/site/pdf/Patent-Marking.pdf. **onsemi** reserves the right to make changes at any time to any products or information herein, without notice. The information herein is provided "as-is" and **onsemi** makes no warranty, representation or guarantee regarding the accuracy of the information, product features, availability, functionality, or suitability of its products for any particular purpose, nor does **onsemi** assume any liability arising out of the application or use of any product or circuit, and specifically disclaims any and all liability, including without limitation special, consequential or incidental damages. Buyer is responsible for its products and applications using **onsemi** products, including compliance with all laws, regulations and safety requirements or standards, regardless of any support or applications information provided by **onsemi**. "Typical" parameters which may be provided in **onsemi** data sheets and/or specifications can and do vary in different applications and actual performance may vary over time. All operating parameters, including "Typicals" must be validated for each customer application by customer's technical experts. **onsemi** does not convey any license under any of its intellectual property rights nor the rights of others. **onsemi** products are not designed, intended, or authorized for use as a critical component in life support systems or any FDA Class 3 medical devices or medical devices with a same or similar classification in a foreign jurisdiction or any devices intended for implantation in the human body. Should Buyer purchase or use **onsemi** products for any such unintended or unauthorized application, Buyer shall indemnify and hold **onsemi** and its officers, employees, subsidiaries, affiliates, and distributors harmless against all claims, costs, damages, and expenses, and reasonable attorney fees arising out of, directly or indirectly, any claim of personal injury or death associated with such unintended or unauthorized use, even if such claim alleges that **onsemi** was negligent regarding the design or manufacture of the part. **onsemi** is an Equal Opportunity/Affirmative Action Employer. This literature is subject to all applicable copyright laws and is not for resale in any manner.

PUBLICATION ORDERING INFORMATION

LITERATURE FULFILLMENT:

Email Requests to: orderlit@onsemi.com

onsemi Website: www.onsemi.com

TECHNICAL SUPPORT

North American Technical Support:

Voice Mail: 1 800-282-9855 Toll Free USA/Canada

Phone: 011 421 33 790 2910

Europe, Middle East and Africa Technical Support:

Phone: 00421 33 790 2910

For additional information, please contact your local Sales Representative