

NTLGF3402P

MOSFET – Power, P-Channel, Schottky Diode, Schottky Barrier Diode, FETKY, DFN6

-20 V, -3.9 A, 2.0 A

Features

- Flat Lead 6 Terminal Package 3x3x1 mm
- Enhanced Thermal Characteristics
- Low V_F and Low Leakage Schottky Diode
- Reduced Gate Charge to Improve Switching Response
- This is a Pb-Free Device

Applications

- Buck Converter
- High Side DC-DC Conversion Circuits
- Power Management in Portable, HDD and Computing

MOSFET MAXIMUM RATINGS ($T_J = 25^\circ\text{C}$ unless otherwise noted)

Parameter		Symbol	Value	Unit	
Drain-to-Source Voltage		V_{DSS}	-20	V	
Gate-to-Source Voltage		V_{GS}	± 12	V	
Continuous Drain Current (Note 1)	Steady State	$T_A = 25^\circ\text{C}$	I_D	-2.7	A
			$T_A = 85^\circ\text{C}$	-2.0	
	$t \leq 10\text{ s}$	$T_A = 25^\circ\text{C}$	I_D	-3.9	
Power Dissipation (Note 1)	Steady State	$T_A = 25^\circ\text{C}$	P_D	1.6	W
	$t \leq 10\text{ s}$		P_D	3.0	
Continuous Drain Current (Note 2)	Steady State	$T_A = 25^\circ\text{C}$	I_D	-2.3	A
		$T_A = 85^\circ\text{C}$	I_D	-1.7	
		$T_A = 25^\circ\text{C}$	P_D	1.14	
Pulsed Drain Current	$t_p = 10\ \mu\text{s}$	I_{DM}	11	A	
Operating Junction and Storage Temperature		T_J, T_{STG}	-55 to 150	$^\circ\text{C}$	
Source Current (Body Diode)		I_S	1.1	A	
Lead Temperature for Soldering Purposes (1/8" from case for 10 s)		T_L	260	$^\circ\text{C}$	

Stresses exceeding Maximum Ratings may damage the device. Maximum Ratings are stress ratings only. Functional operation above the Recommended Operating Conditions is not implied. Extended exposure to stresses above the Recommended Operating Conditions may affect device reliability.

1. Surface Mounted on FR4 Board using 1 in sq pad size (Cu area = 1.127 in sq [1 oz] including traces).
2. Surface Mounted on FR4 Board using the minimum recommended pad size (Cu area = 0.5 in sq).



ON Semiconductor®

<http://onsemi.com>

MOSFET

$V_{(BR)DSS}$	$R_{DS(on)}$ TYP	I_D MAX
-20 V	110 m Ω @ -4.5 V	-3.9 A

SCHOTTKY DIODE

V_R MAX	V_F TYP	I_F MAX
20 V	0.36 V	2.0 A

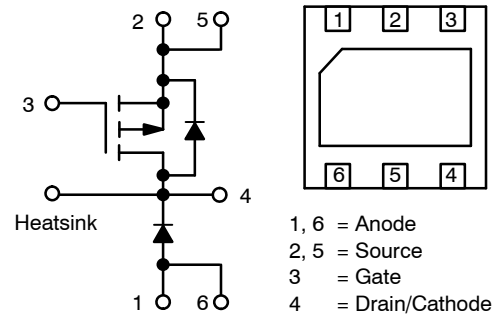

MARKING DIAGRAMS



**DFN6
CASE 506AH**

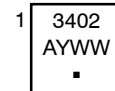

3402 = Specific Device Code
A = Assembly Location
Y = Year
WW = Work Week
▪ = Pb-Free Package

ORDERING INFORMATION

Device	Package	Shipping†
NTLGF3402PT1G	DFN6 (Pb-Free)	3000 / Tape & Reel
NTLGF3402PT2G	DFN6 (Pb-Free)	3000 / Tape & Reel

†For information on tape and reel specifications, including part orientation and tape sizes, please refer to our Tape and Reel Packaging Specifications Brochure, BRD8011/D.

NTLGF3402P

SCHOTTKY DIODE MAXIMUM RATINGS ($T_J = 25^\circ\text{C}$ unless otherwise noted)

Parameter	Symbol	Max	Unit
Peak Repetitive Reverse Voltage	V_{RRM}	20	V
DC Blocking Voltage	V_R	20	V
Average Rectified Forward Current	I_F	2.0	A

THERMAL RESISTANCE RATINGS

Parameter	Symbol	Max	Unit
Junction-to-Ambient – Steady State (Note 2)	$R_{\theta JA}$	110	$^\circ\text{C}/\text{W}$
Junction-to-Ambient – $t \leq 10$ s (Note 2)	$R_{\theta JA}$	58	$^\circ\text{C}/\text{W}$
Junction-to-Ambient – Steady State (Note 3)	$R_{\theta JA}$	79	$^\circ\text{C}/\text{W}$
Junction-to-Ambient – $t \leq 10$ s (Note 3)	$R_{\theta JA}$	41	$^\circ\text{C}/\text{W}$

3. Surface Mounted on FR4 Board using 1 in sq pad size (Cu area = 1.127 in sq [1 oz] including traces).

MOSFET ELECTRICAL CHARACTERISTICS ($T_J = 25^\circ\text{C}$ unless otherwise noted)

Parameter	Symbol	Test Conditions	Min	Typ	Max	Unit
-----------	--------	-----------------	-----	-----	-----	------

OFF CHARACTERISTICS

Drain-to-Source Breakdown Voltage	$V_{(BR)DSS}$	$V_{GS} = 0$ V, $I_D = -250$ μA	-20			V
Drain-to-Source Breakdown Voltage Temperature Coefficient	$V_{(BR)DSS}/T_J$			-9.0		$\text{mV}/^\circ\text{C}$
Zero Gate Voltage Drain Current	I_{DSS}	$V_{DS} = -16$ V, $V_{GS} = 0$ V	$T_J = 25^\circ\text{C}$		-1.0	μA
			$T_J = 125^\circ\text{C}$		-5.0	
Gate-to-Source Leakage Current	I_{GSS}	$V_{DS} = 0$ V, $V_{GS} = \pm 12$ V			± 100	nA

ON CHARACTERISTICS (Note 4)

Gate Threshold Voltage	$V_{GS(TH)}$	$V_{GS} = V_{DS}$, $I_D = -250$ μA	-0.6		-2.0	V
Gate Threshold Temperature Coefficient	$V_{GS(TH)}/T_J$			2.7		$\text{mV}/^\circ\text{C}$
Drain-to-Source On-Resistance	$R_{DS(on)}$	$V_{GS} = -4.5$ V, $I_D = -2.7$ A		110	140	$\text{m}\Omega$
		$V_{GS} = -2.5$ V, $I_D = -1.0$ A		190	225	
Forward Transconductance	g_{FS}	$V_{DS} = -10$ V, $I_D = -2.7$ A		4.8		S

CHARGES AND CAPACITANCES

Input Capacitance	C_{ISS}	$V_{GS} = 0$ V, $f = 1.0$ MHz, $V_{DS} = -10$ V		230	350	pF
Output Capacitance	C_{OSS}			105	225	
Reverse Transfer Capacitance	C_{RSS}			40	75	
Total Gate Charge	$Q_{G(TOT)}$	$V_{GS} = -4.5$ V, $V_{DS} = -10$ V, $I_D = -2.7$ A		3.8	10	nC
Threshold Gate Charge	$Q_{G(TH)}$			0.32		
Gate-to-Source Charge	Q_{GS}			0.7		
Gate-to-Drain Charge	Q_{GD}			1.6		

SWITCHING CHARACTERISTICS (Note 5)

Turn-On Delay Time	$t_{d(ON)}$	$V_{GS} = -4.5$ V, $V_{DD} = -16$ V, $I_D = -2.7$ A, $R_G = 2.4$ Ω		6.2	15	ns
Rise Time	t_r			22	30	
Turn-Off Delay Time	$t_{d(OFF)}$			25	45	
Fall Time	t_f			34	60	

4. Pulse Test: Pulse Width ≤ 300 μs , Duty Cycle $\leq 2\%$.

5. Switching characteristics are independent of operating junction temperatures.

NTLGF3402P

MOSFET ELECTRICAL CHARACTERISTICS ($T_J = 25^\circ\text{C}$ unless otherwise noted)

Parameter	Symbol	Test Conditions	Min	Typ	Max	Unit
-----------	--------	-----------------	-----	-----	-----	------

DRAIN-SOURCE DIODE CHARACTERISTICS

Forward Diode Voltage	V_{SD}	$V_{GS} = 0\text{ V}, I_S = -1.1\text{ A}$		$T_J = 25^\circ\text{C}$		-0.8	-1.2	V
Reverse Recovery Time	t_{RR}	$V_{GS} = 0\text{ V}, I_S = -1.1\text{ A},$ $di_S/dt = 100\text{ A}/\mu\text{s}$				53		ns
Charge Time	t_a					15		
Discharge Time	t_b					38		
Reverse Recovery Charge	Q_{RR}					37		

SCHOTTKY DIODE ELECTRICAL CHARACTERISTICS ($T_J = 25^\circ\text{C}$ unless otherwise noted)

Parameter	Symbol	Test Conditions	Min	Typ	Max	Unit
Maximum Instantaneous Forward Voltage	V_F	$I_F = 0.1\text{ A}$		0.32	0.34	V
		$I_F = 1.0\text{ A}$		0.36	0.39	
Maximum Instantaneous Reverse Current	I_R	$V_R = 5\text{ V}, T_J = 100^\circ\text{C}$			12	mA
		$V_R = 10\text{ V}$		70		μA
		$V_R = 20\text{ V}$		225		

6. Pulse Test: Pulse Width $\leq 300\ \mu\text{s}$, Duty Cycle $\leq 2\%$.
7. Switching characteristics are independent of operating junction temperatures.

NTLGF3402P

TYPICAL P-CHANNEL PERFORMANCE CURVES

($T_J = 25^\circ\text{C}$ unless otherwise noted)

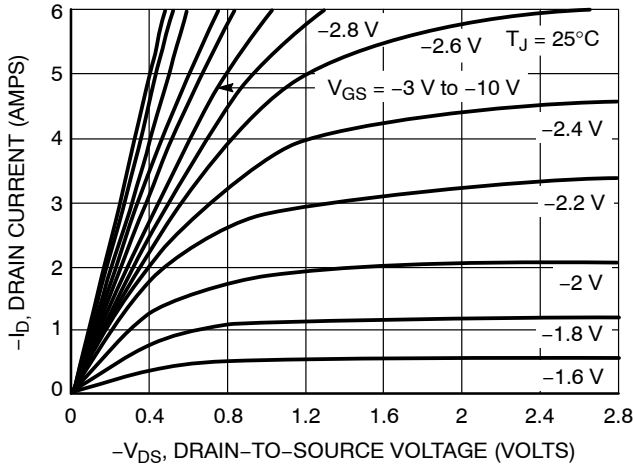

Figure 1. On-Region Characteristics

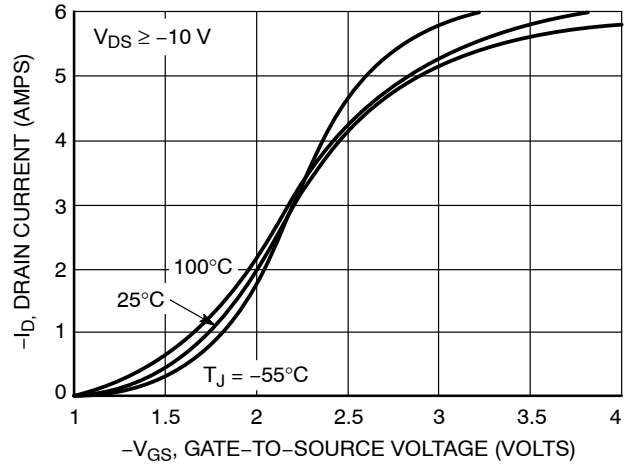

Figure 2. Transfer Characteristics

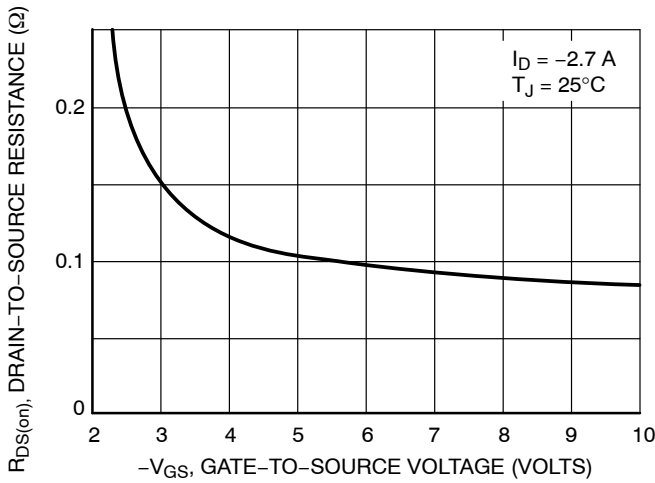

Figure 3. On-Resistance vs. Gate-to-Source Voltage

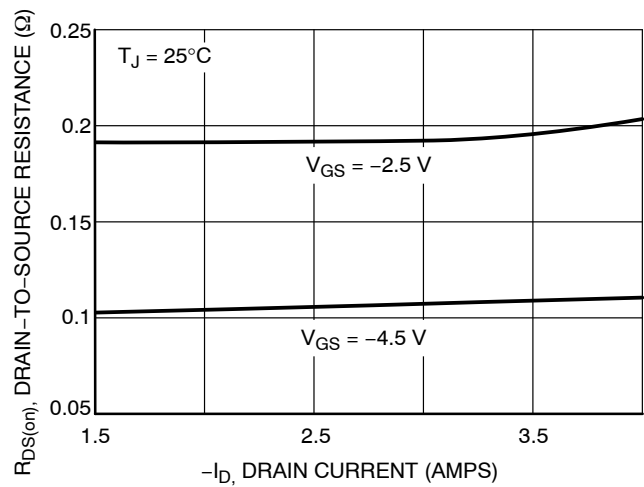

Figure 4. On-Resistance vs. Drain Current and Gate Voltage

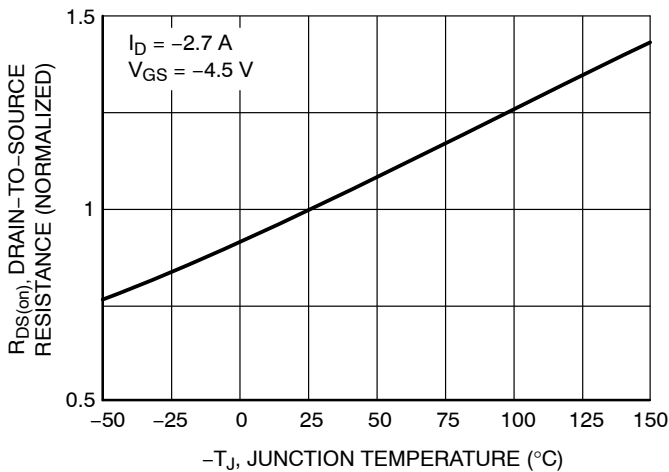

Figure 5. On-Resistance Variation with Temperature

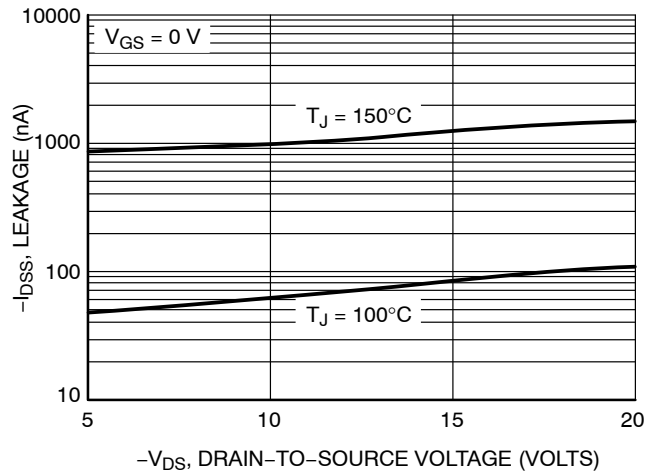

Figure 6. Drain-to-Source Leakage Current vs. Voltage

NTLGF3402P

TYPICAL P-CHANNEL PERFORMANCE CURVES

($T_J = 25^\circ\text{C}$ unless otherwise noted)

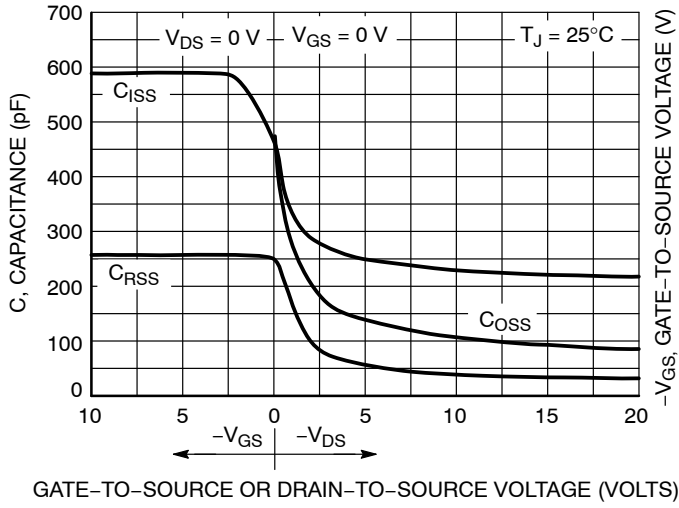

Figure 7. Capacitance Variation

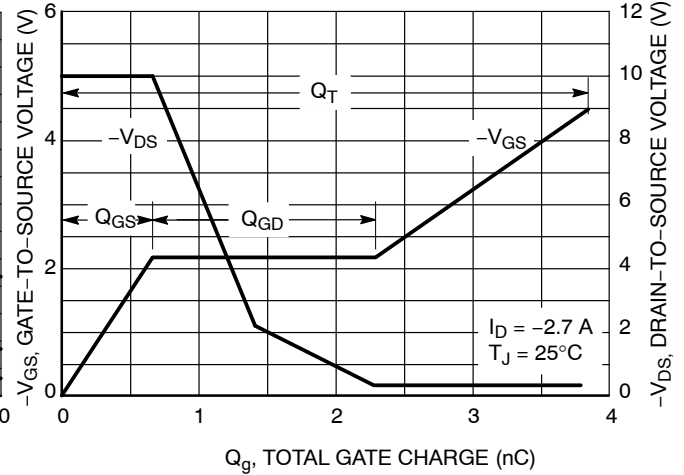

Figure 8. Gate-to-Source and Drain-to-Source Voltage vs. Total Charge

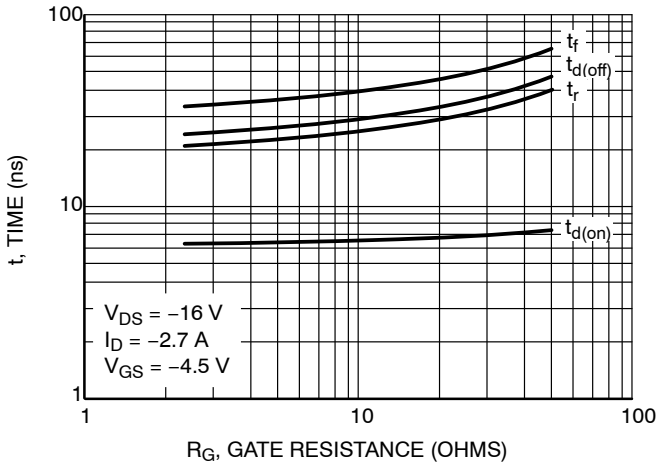

Figure 9. Resistive Switching Time Variation vs. Gate Resistance

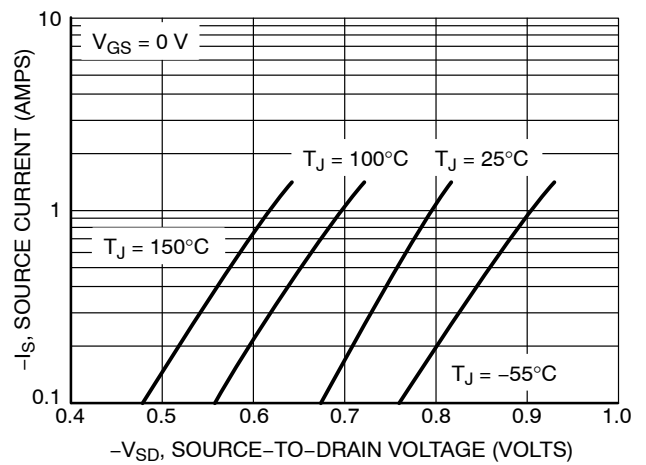

Figure 10. Diode Forward Voltage vs. Current

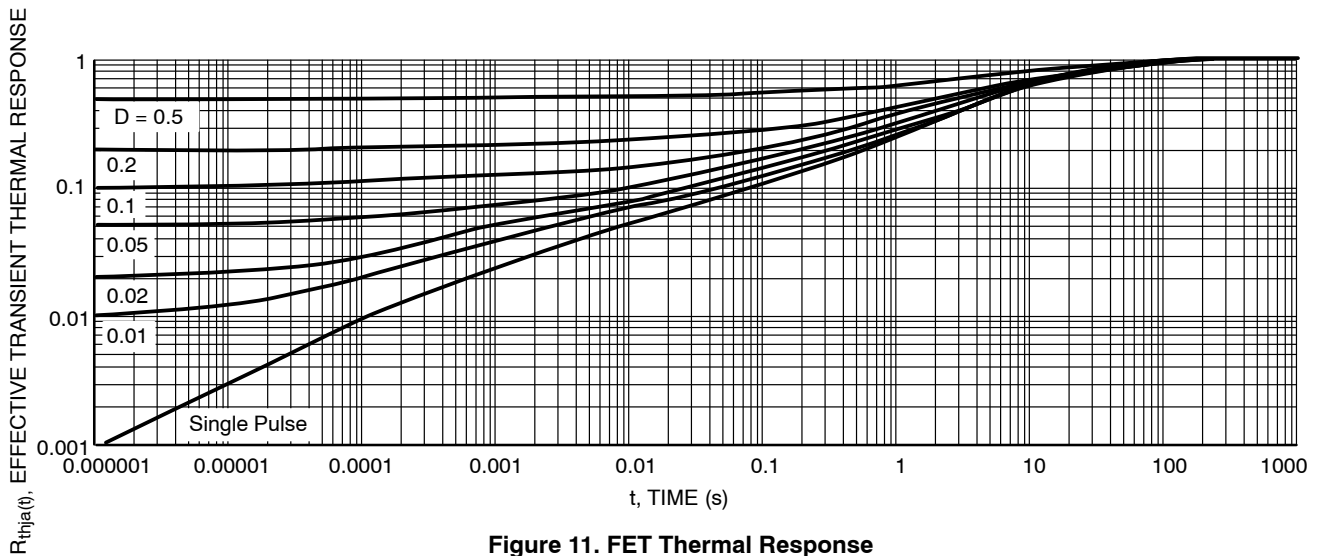

Figure 11. FET Thermal Response

NTLGF3402P

TYPICAL SCHOTTKY PERFORMANCE CURVES ($T_J = 25^\circ\text{C}$ unless otherwise noted)

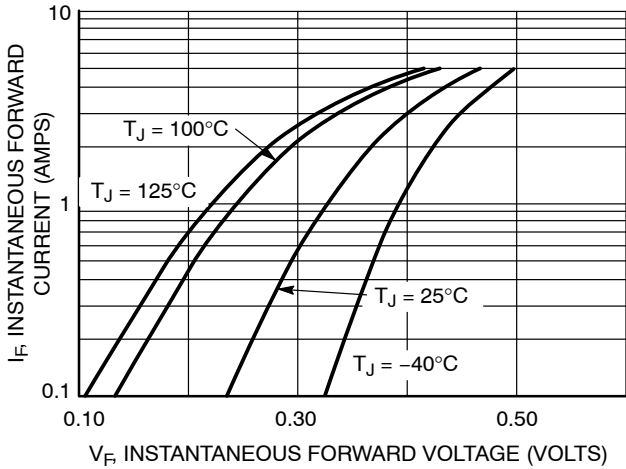

Figure 12. Typical Forward Voltage

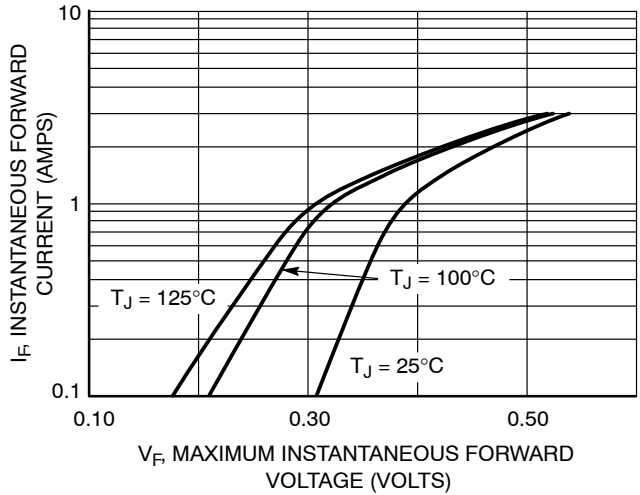

Figure 13. Maximum Forward Voltage

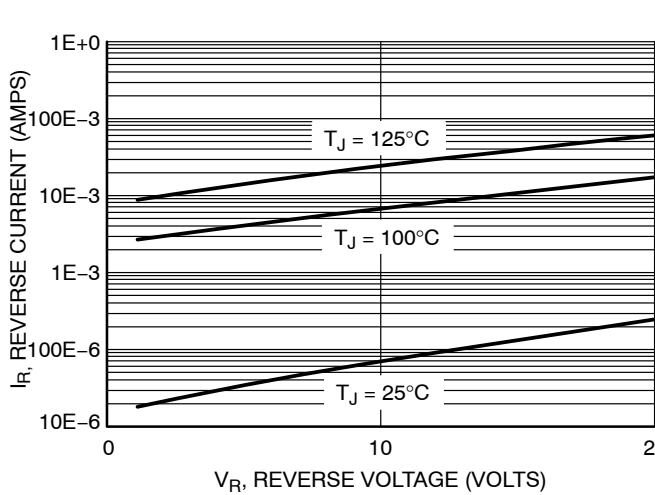

Figure 14. Typical Reverse Current

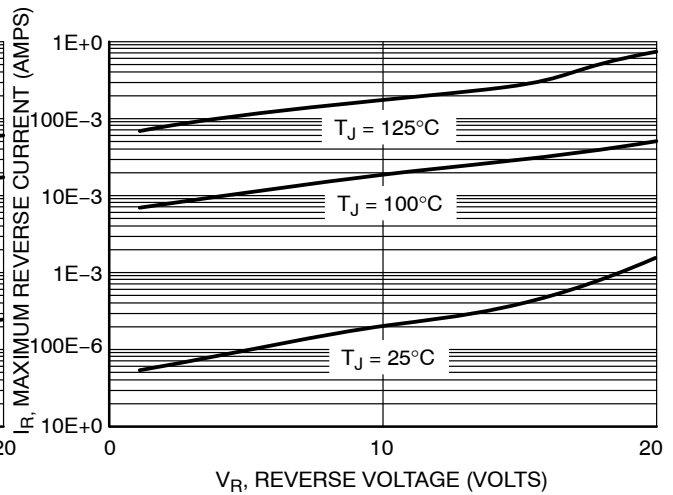

Figure 15. Maximum Reverse Current

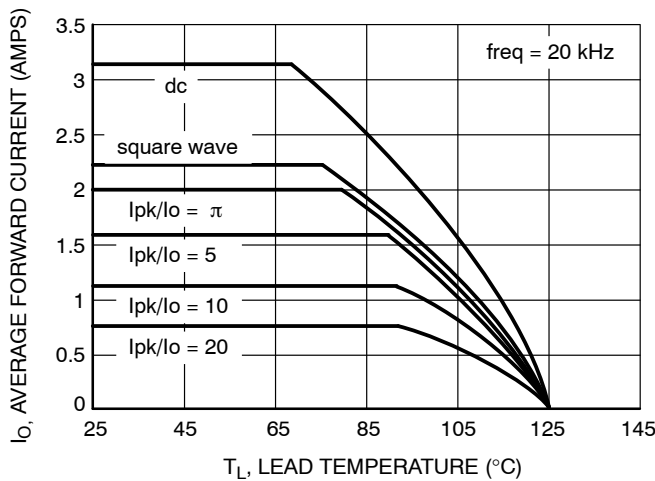

Figure 16. Current Derating

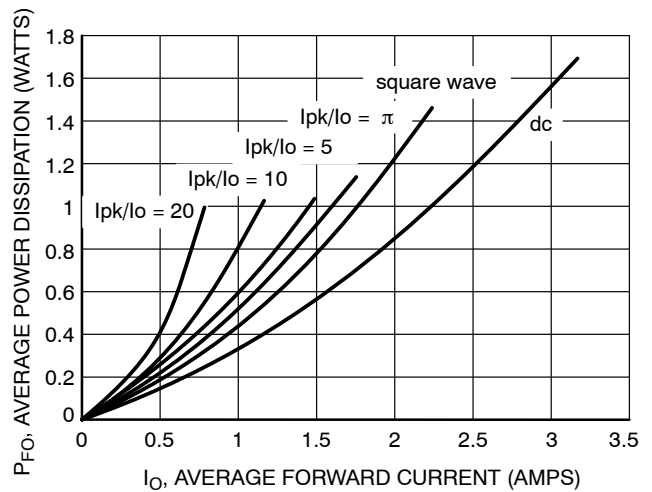

Figure 17. Forward Power Dissipation

NTLGF3402P

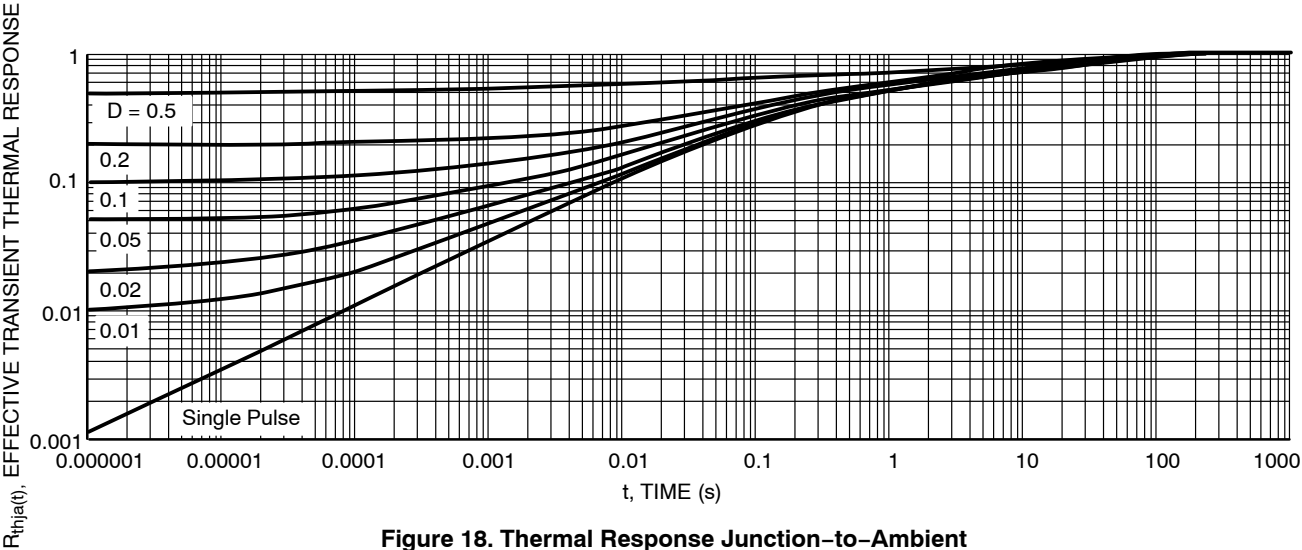

Figure 18. Thermal Response Junction-to-Ambient

FETKY is a registered trademark of International Rectifier Corporation.

MECHANICAL CASE OUTLINE

PACKAGE DIMENSIONS

ON Semiconductor®



1
SCALE 2:1

DFN6 3*3 MM, 0.95 PITCH
CASE 506AH-01
ISSUE O

DATE 17 NOV 2004

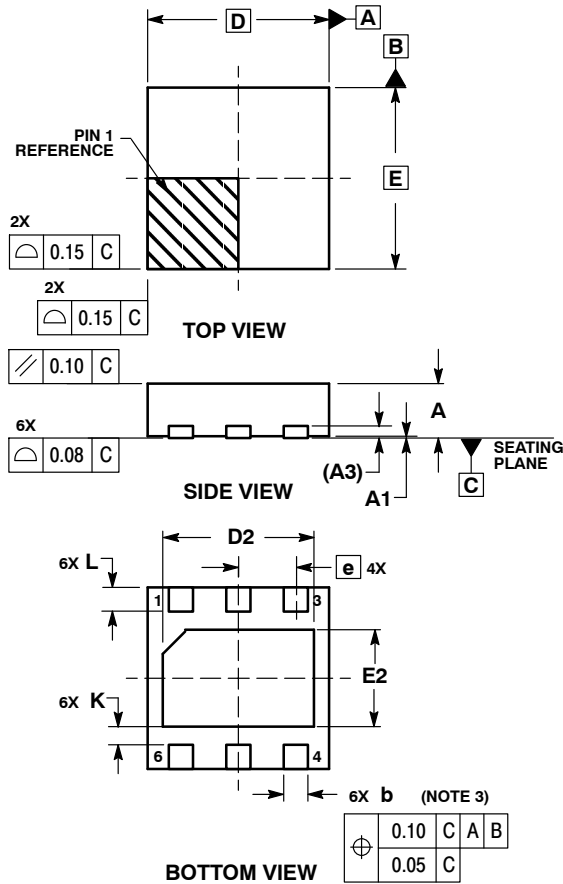

SOLDERING FOOTPRINT*

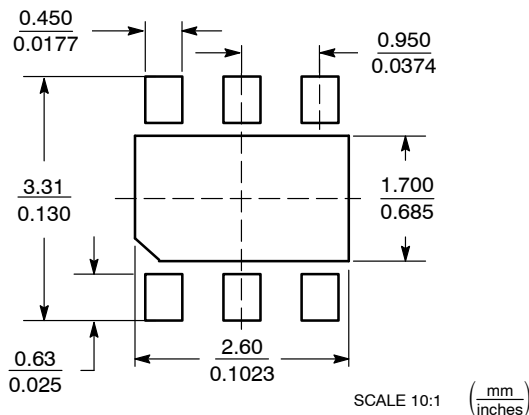

NOTES:

1. DIMENSIONS AND TOLERANCING PER ASME Y14.5M, 1994.
2. CONTROLLING DIMENSION: MILLIMETERS.
3. DIMENSION b APPLIES TO PLATED TERMINAL AND IS MEASURED BETWEEN 0.25 AND 0.30 MM FROM TERMINAL.
4. COPLANARITY APPLIES TO THE EXPOSED PAD AS WELL AS THE TERMINALS.

MILLIMETERS			
DIM	MIN	NOM	MAX
A	0.80	0.90	1.00
A1	0.00	0.03	0.05
A3	0.20 REF		
b	0.35	0.40	0.45
D	3.00 BSC		
D2	2.40	2.50	2.60
E	3.00 BSC		
E2	1.50	1.60	1.70
e	0.95 BSC		
K	0.21	---	---
L	0.30	0.40	0.50

GENERIC MARKING DIAGRAM*

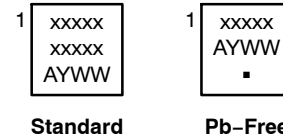

- xxxxx = Specific Device Code
A = Assembly Location
Y = Year
WW = Work Week
■ = Pb-Free Package

*This information is generic. Please refer to device data sheet for actual part marking.

Pb-Free indicator, "G" or microdot "■", may or may not be present.

*For additional information on our Pb-Free strategy and soldering details, please download the ON Semiconductor Soldering and Mounting Techniques Reference Manual, SOLDERRM/D.

DOCUMENT NUMBER:	98AON19891D	Electronic versions are uncontrolled except when accessed directly from the Document Repository. Printed versions are uncontrolled except when stamped "CONTROLLED COPY" in red.
DESCRIPTION:	DFN6 3*3 MM, 0.95 PITCH, SINGLE FLAG	PAGE 1 OF 1

ON Semiconductor and ON are trademarks of Semiconductor Components Industries, LLC dba ON Semiconductor or its subsidiaries in the United States and/or other countries. ON Semiconductor reserves the right to make changes without further notice to any products herein. ON Semiconductor makes no warranty, representation or guarantee regarding the suitability of its products for any particular purpose, nor does ON Semiconductor assume any liability arising out of the application or use of any product or circuit, and specifically disclaims any and all liability, including without limitation special, consequential or incidental damages. ON Semiconductor does not convey any license under its patent rights nor the rights of others.

onsemi, **Onsemi**, and other names, marks, and brands are registered and/or common law trademarks of Semiconductor Components Industries, LLC dba "**onsemi**" or its affiliates and/or subsidiaries in the United States and/or other countries. **onsemi** owns the rights to a number of patents, trademarks, copyrights, trade secrets, and other intellectual property. A listing of **onsemi**'s product/patent coverage may be accessed at www.onsemi.com/site/pdf/Patent-Marking.pdf. **onsemi** reserves the right to make changes at any time to any products or information herein, without notice. The information herein is provided "as-is" and **onsemi** makes no warranty, representation or guarantee regarding the accuracy of the information, product features, availability, functionality, or suitability of its products for any particular purpose, nor does **onsemi** assume any liability arising out of the application or use of any product or circuit, and specifically disclaims any and all liability, including without limitation special, consequential or incidental damages. Buyer is responsible for its products and applications using **onsemi** products, including compliance with all laws, regulations and safety requirements or standards, regardless of any support or applications information provided by **onsemi**. "Typical" parameters which may be provided in **onsemi** data sheets and/or specifications can and do vary in different applications and actual performance may vary over time. All operating parameters, including "Typicals" must be validated for each customer application by customer's technical experts. **onsemi** does not convey any license under any of its intellectual property rights nor the rights of others. **onsemi** products are not designed, intended, or authorized for use as a critical component in life support systems or any FDA Class 3 medical devices or medical devices with a same or similar classification in a foreign jurisdiction or any devices intended for implantation in the human body. Should Buyer purchase or use **onsemi** products for any such unintended or unauthorized application, Buyer shall indemnify and hold **onsemi** and its officers, employees, subsidiaries, affiliates, and distributors harmless against all claims, costs, damages, and expenses, and reasonable attorney fees arising out of, directly or indirectly, any claim of personal injury or death associated with such unintended or unauthorized use, even if such claim alleges that **onsemi** was negligent regarding the design or manufacture of the part. **onsemi** is an Equal Opportunity/Affirmative Action Employer. This literature is subject to all applicable copyright laws and is not for resale in any manner.

ADDITIONAL INFORMATION

TECHNICAL PUBLICATIONS:

Technical Library: www.onsemi.com/design/resources/technical-documentation
onsemi Website: www.onsemi.com

ONLINE SUPPORT: www.onsemi.com/support

For additional information, please contact your local Sales Representative at www.onsemi.com/support/sales