

NTGS3441P

Power MOSFET

-20 V, -3.16 A, Single P-Channel TSOP-6

Features

- Ultra Low $R_{DS(on)}$ to Improve Conduction Loss
- Low Gate Charge to Improve Switching Losses
- TSOP-6 Surface Mount Package
- This is a Pb-Free Device

Applications

- High Side Switch in DC-DC Converters
- Battery Management

MAXIMUM RATINGS ($T_J = 25^\circ\text{C}$ unless otherwise stated)

Parameter			Symbol	Value	Unit
Drain-to-Source Voltage			V_{DSS}	-20	V
Gate-to-Source Voltage			V_{GS}	± 12	V
Continuous Drain Current (Note 1)	Steady State	$T_A = 25^\circ\text{C}$	I_D	-2.5	A
		$T_A = 85^\circ\text{C}$		-1.8	
	$t = 10\text{ s}$	$T_A = 25^\circ\text{C}$		-3.16	
Power Dissipation (Note 1)	Steady State	$T_A = 25^\circ\text{C}$	P_D	0.98	W
	$t = 10\text{ s}$			1.60	
Continuous Drain Current (Note 2)	Steady State	$T_A = 25^\circ\text{C}$	I_D	-1.8	A
		$T_A = 85^\circ\text{C}$		-1.3	
Power Dissipation (Note 2)		$T_A = 25^\circ\text{C}$	P_D	0.51	W
Pulsed Drain Current	$t_p = 10\ \mu\text{s}$		I_{DM}	-13	A
Operating Junction and Storage Temperature			T_J, T_{STG}	-55 to 150	$^\circ\text{C}$
Source Current (Body Diode)			I_S	-1.5	A
Lead Temperature for Soldering Purposes (1/8" from case for 10 s)			T_L	260	$^\circ\text{C}$

Maximum ratings are those values beyond which device damage can occur. Maximum ratings applied to the device are individual stress limit values (not normal operating conditions) and are not valid simultaneously. If these limits are exceeded, device functional operation is not implied, damage may occur and reliability may be affected.

1. Surface-mounted on FR4 board using 1 in sq pad size (Cu area = 1.127 in sq [1 oz] including traces)
2. Surface-mounted on FR4 board using the minimum recommended pad size (Cu area = 0.0751 in sq)



ON Semiconductor®

<http://onsemi.com>

$V_{(BR)DSS}$	$R_{DS(ON)}$ TYP	I_D MAX
-20 V	91 m Ω @ 4.5 V	-3.16 A
	144 m Ω @ 2.7 V	
	188 m Ω @ 2.5 V	

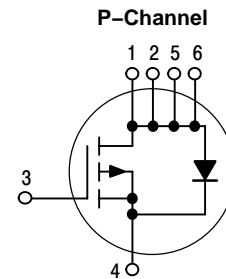

MARKING DIAGRAM



TSOP-6
CASE 318G
STYLE 1

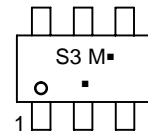

PT = Device Code
M = Date Code
▪ = Pb-Free Package
(Note: Microdot may be in either location)

PIN ASSIGNMENT

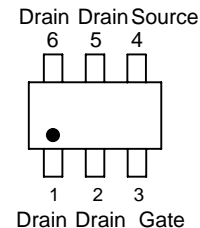

ORDERING INFORMATION

Device	Package	Shipping†
NTGS3441PT1G	TSOP-6 (Pb-Free)	3000 / Tape & Reel

†For information on tape and reel specifications, including part orientation and tape sizes, please refer to our Tape and Reel Packaging Specifications Brochure, BRD8011/D.

NTGS3441P

THERMAL RESISTANCE MAXIMUM RATINGS

Parameter	Symbol	Value	Unit
Junction-to-Ambient – Steady State (Note 3)	$R_{\theta JA}$	128	°C/W
Junction-to-Ambient – $t = 10$ s (Note 3)	$R_{\theta JA}$	78	
Junction-to-Ambient – Steady State (Note 4)	$R_{\theta JA}$	244	

3. Surface-mounted on FR4 board using 1 in sq pad size (Cu area = 1.127 in sq [1 oz] including traces)
 4. Surface-mounted on FR4 board using the minimum recommended pad size (Cu area = TBD in sq)

ELECTRICAL CHARACTERISTICS ($T_J = 25^\circ\text{C}$ unless otherwise specified)

Parameter	Symbol	Test Condition	Min	Typ	Max	Unit
-----------	--------	----------------	-----	-----	-----	------

OFF CHARACTERISTICS

Drain-to-Source Breakdown Voltage	$V_{(BR)DSS}$	$V_{GS} = 0$ V, $I_D = -250$ μA	-20			V
Drain-to-Source Breakdown Voltage Temperature Coefficient	$V_{(BR)DSS}/T_J$			16		mV/°C
Zero Gate Voltage Drain Current	I_{DSS}	$V_{GS} = 0$ V, $V_{DS} = -20$ V			-1	μA
					-10	
Gate-to-Source Leakage Current	I_{GSS}	$V_{DS} = 0$ V, $V_{GS} = \pm 12$ V			± 100	nA

ON CHARACTERISTICS (Note 5)

Gate Threshold Voltage	$V_{GS(TH)}$	$V_{GS} = V_{DS}$, $I_D = -250$ μA	0.6		1.6	V
Negative Threshold Temperature Coefficient	$V_{GS(TH)}/T_J$			3.2		mV/°C
Drain-to-Source On Resistance	$R_{DS(on)}$	$V_{GS} = 4.5$ V, $I_D = -3.0$ A		91	110	m Ω
		$V_{GS} = 2.7$ V, $I_D = -1.5$ A		144	165	
		$V_{GS} = 2.5$ V, $I_D = -1.5$ A		188		
Forward Transconductance	g_{FS}	$V_{DS} = -15$ V, $I_D = -1.5$ A		4.0		S

CHARGES, CAPACITANCES AND GATE RESISTANCE

Input Capacitance	C_{ISS}	$V_{GS} = 0$ V, $f = 1$ MHz, $V_{DS} = -15$ V		345		pF
Output Capacitance	C_{OSS}			150		
Reverse Transfer Capacitance	C_{RSS}			40		
Total Gate Charge	$Q_{G(TOT)}$	$V_{GS} = 4.5$ V, $V_{DS} = -10$ V; $I_D = -3.0$ A		3.25	6.0	nC
Threshold Gate Charge	$Q_{G(TH)}$			0.3		
Gate-to-Source Charge	Q_{GS}			0.6		
Gate-to-Drain Charge	Q_{GD}			1.4		

SWITCHING CHARACTERISTICS (Note 6)

Turn-On Delay Time	$t_{d(ON)}$	$V_{GS} = 4.5$ V, $V_{DD} = -10$ V, $I_D = -1.5$ A, $R_G = 4.7$ Ω		7.0	12	ns
Rise Time	T_r			14	25	
Turn-Off Delay Time	$t_{d(OFF)}$			13	25	
Fall Time	T_f			4.0	8.0	

DRAIN-SOURCE DIODE CHARACTERISTICS

Forward Diode Voltage	V_{SD}	$V_{GS} = 0$ V, $I_S = -3.0$ A	$T_J = 25^\circ\text{C}$		0.8	1.2	V
			$T_J = 125^\circ\text{C}$		0.7		
Reverse Recovery Time	t_{RR}	$V_{GS} = 0$ V, $dI_S/dt = 100$ A/ μs , $I_S = -3.0$ A		25		ns	
Charge Time	T_a			10			
Discharge Time	T_b			15			
Reverse Recovery Charge	Q_{RR}			15			nC

5. Switching characteristics are independent of operating junction temperatures
 6. Pulse Test: pulse width = 300 μs , duty cycle = 2%

NTGS3441P

TYPICAL PERFORMANCE CURVES ($T_J = 25^\circ\text{C}$ unless otherwise noted)

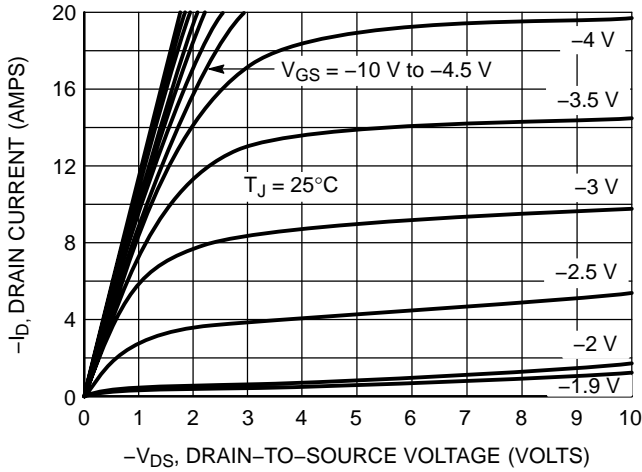

Figure 1. On-Region Characteristics

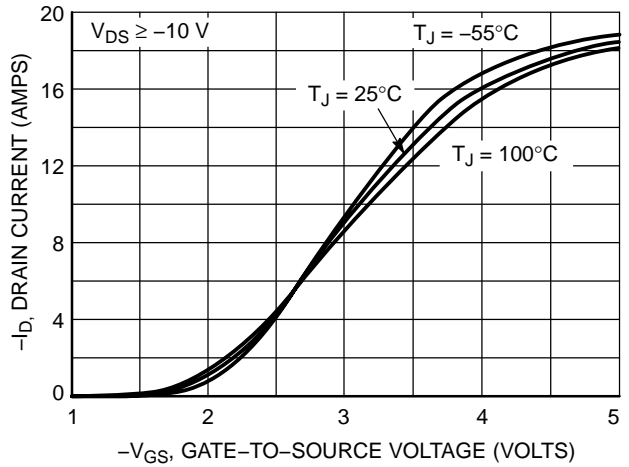

Figure 2. Transfer Characteristics

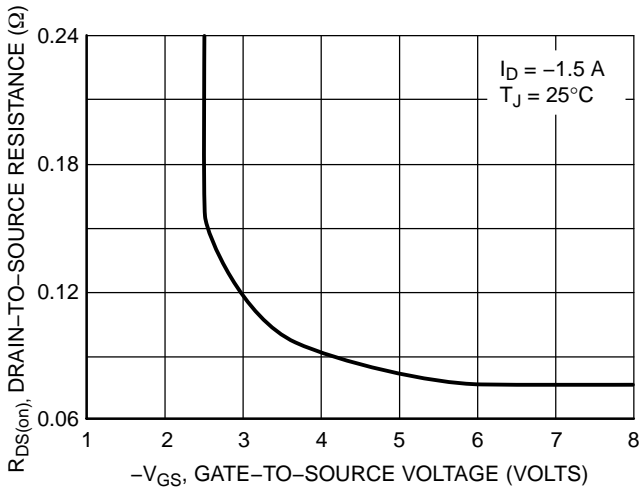

Figure 3. On-Resistance vs. Gate-to-Source Voltage

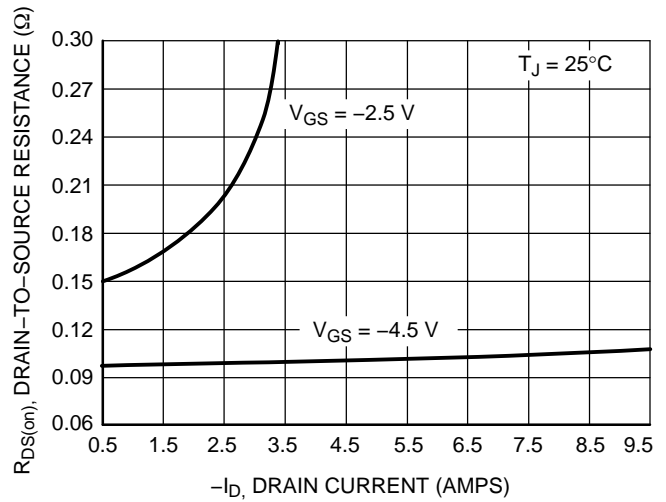

Figure 4. On-Resistance vs. Drain Current and Gate Voltage

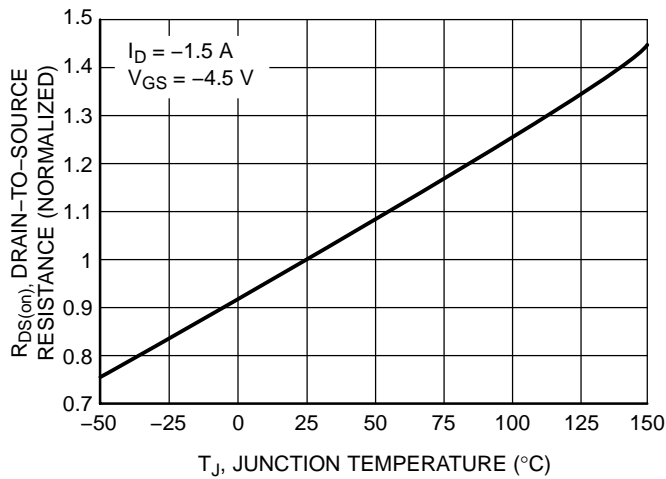

Figure 5. On-Resistance Variation with Temperature

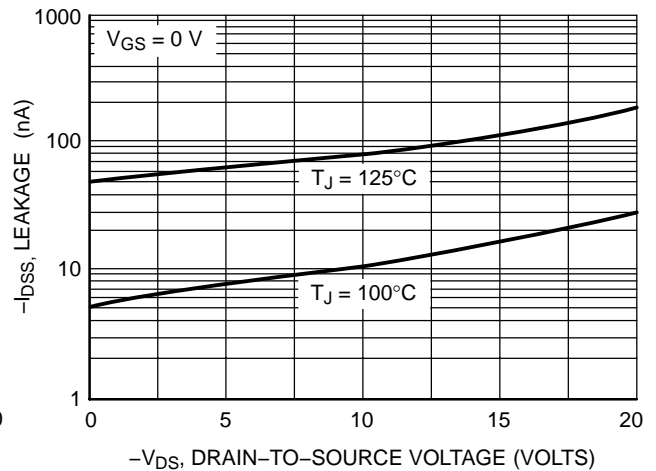

Figure 6. Drain-to-Source Leakage Current vs. Voltage

NTGS3441P

TYPICAL PERFORMANCE CURVES ($T_J = 25^\circ\text{C}$ unless otherwise noted)

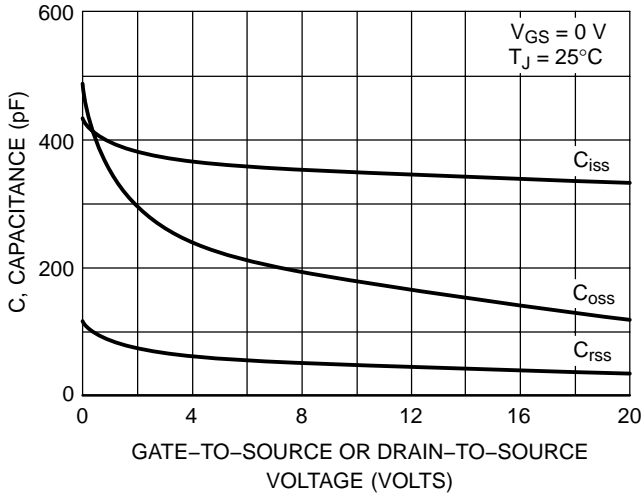

Figure 7. Capacitance Variation

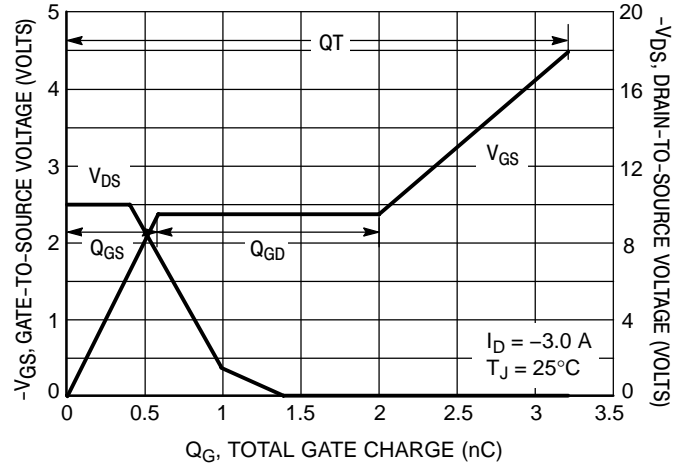

Figure 8. Gate-to-Source and Drain-to-Source Voltage vs. Total Charge

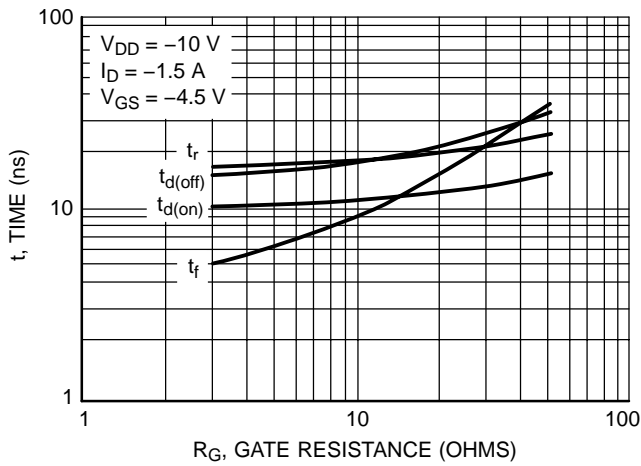

Figure 9. Gate Threshold Voltage Variation with Temperature

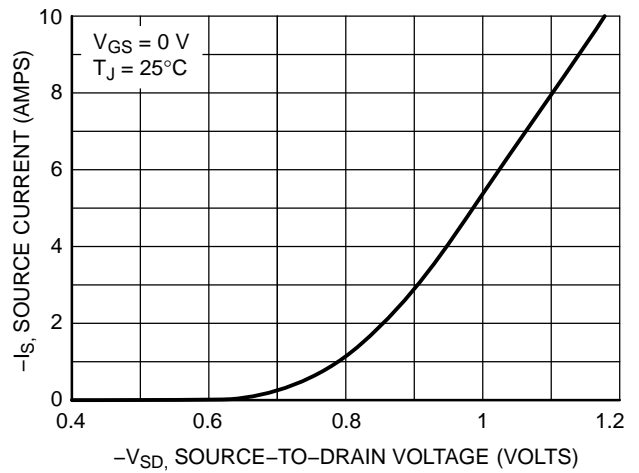
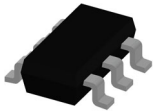

Figure 10. Diode Forward Voltage vs. Current

MECHANICAL CASE OUTLINE PACKAGE DIMENSIONS



TSOP-6 3.00x1.50x0.90, 0.95P
CASE 318G
ISSUE W

DATE 26 FEB 2024

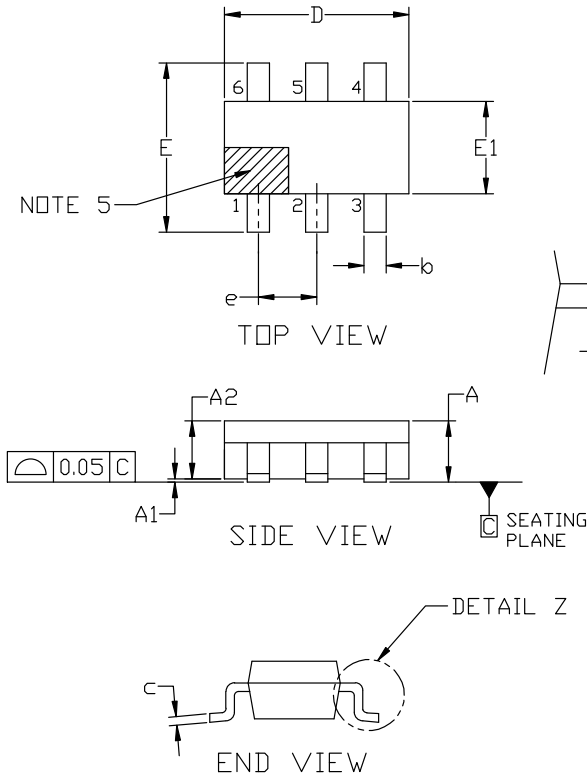

NOTES:

1. DIMENSIONING AND TOLERANCING PER ASME Y14.5M, 2018.
2. CONTROLLING DIMENSION: MILLIMETERS.
3. MAXIMUM LEAD THICKNESS INCLUDES LEAD FINISH. MINIMUM LEAD THICKNESS IS THE MINIMUM THICKNESS OF BASE MATERIAL.
4. DIMENSIONS D AND E1 DO NOT INCLUDE MOLD FLASH, PROTRUSIONS, OR GATE BURRS. MOLD FLASH, PROTRUSIONS, OR GATE BURRS SHALL NOT EXCEED 0.15 PER SIDE. DIMENSIONS D AND E1 ARE DETERMINED AT DATUM H.
5. PIN 1 INDICATOR MUST BE LOCATED IN THE INDICATED ZONE

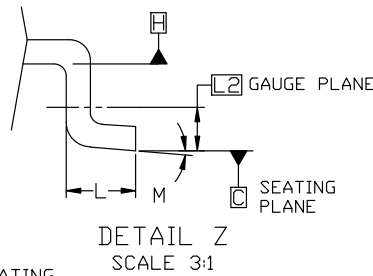

MILLIMETERS			
DIM	MIN	NOM	MAX
A	0.90	1.00	1.10
A1	0.01	0.06	0.10
A2	0.80	0.90	1.00
b	0.25	0.38	0.50
c	0.10	0.18	0.26
D	2.90	3.00	3.10
E	2.50	2.75	3.00
E1	1.30	1.50	1.70
e	0.85	0.95	1.05
L	0.20	0.40	0.60
L2	0.25 BSC		
M	0°	---	10°

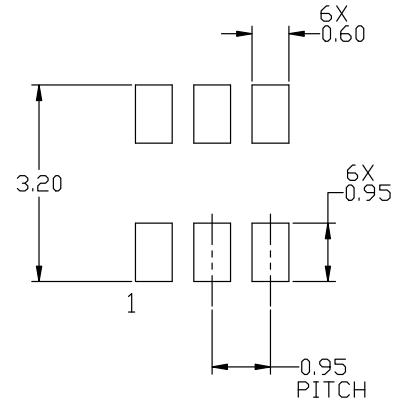

RECOMMENDED MOUNTING FOOTPRINT

*For additional information on our Pb-Free strategy and soldering details, please download the ON Semiconductor Soldering and Mounting Techniques Reference manual, SOLDERRM/D.

DOCUMENT NUMBER:	98ASB14888C	Electronic versions are uncontrolled except when accessed directly from the Document Repository. Printed versions are uncontrolled except when stamped "CONTROLLED COPY" in red.
DESCRIPTION:	TSOP-6 3.00x1.50x0.90, 0.95P	PAGE 1 OF 2

onsemi and ONSEMI are trademarks of Semiconductor Components Industries, LLC dba onsemi or its subsidiaries in the United States and/or other countries. onsemi reserves the right to make changes without further notice to any products herein. onsemi makes no warranty, representation or guarantee regarding the suitability of its products for any particular purpose, nor does onsemi assume any liability arising out of the application or use of any product or circuit, and specifically disclaims any and all liability, including without limitation special, consequential or incidental damages. onsemi does not convey any license under its patent rights nor the rights of others.

MECHANICAL CASE OUTLINE

PACKAGE DIMENSIONS



TSOP-6 3.00x1.50x0.90, 0.95P
CASE 318G
ISSUE W

DATE 26 FEB 2024

GENERIC MARKING DIAGRAM*

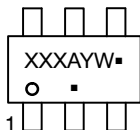

IC

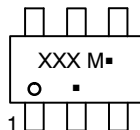

STANDARD

XXX = Specific Device Code
A = Assembly Location
Y = Year
W = Work Week
▪ = Pb-Free Package

XXX = Specific Device Code
M = Date Code
▪ = Pb-Free Package

*This information is generic. Please refer to device data sheet for actual part marking. Pb-Free indicator, "G" or microdot "▪", may or may not be present. Some products may not follow the Generic Marking.

STYLE 1:

- PIN 1. DRAIN
- 2. DRAIN
- 3. GATE
- 4. SOURCE
- 5. DRAIN
- 6. DRAIN

STYLE 2:

- PIN 1. EMITTER 2
- 2. BASE 1
- 3. COLLECTOR 1
- 4. EMITTER 1
- 5. BASE 2
- 6. COLLECTOR 2

STYLE 3:

- PIN 1. ENABLE
- 2. N/C
- 3. R BOOST
- 4. Vz
- 5. V in
- 6. V out

STYLE 4:

- PIN 1. N/C
- 2. V in
- 3. NOT USED
- 4. GROUND
- 5. ENABLE
- 6. LOAD

STYLE 5:

- PIN 1. EMITTER 2
- 2. BASE 2
- 3. COLLECTOR 1
- 4. EMITTER 1
- 5. BASE 1
- 6. COLLECTOR 2

STYLE 6:

- PIN 1. COLLECTOR
- 2. COLLECTOR
- 3. BASE
- 4. EMITTER
- 5. COLLECTOR
- 6. COLLECTOR

STYLE 7:

- PIN 1. COLLECTOR
- 2. COLLECTOR
- 3. BASE
- 4. N/C
- 5. COLLECTOR
- 6. EMITTER

STYLE 8:

- PIN 1. Vbus
- 2. D(in)
- 3. D(in)+
- 4. D(out)+
- 5. D(out)
- 6. GND

STYLE 9:

- PIN 1. LOW VOLTAGE GATE
- 2. DRAIN
- 3. SOURCE
- 4. DRAIN
- 5. DRAIN
- 6. HIGH VOLTAGE GATE

STYLE 10:

- PIN 1. D(OUT)+
- 2. GND
- 3. D(OUT)-
- 4. D(IN)-
- 5. VBUS
- 6. D(IN)+

STYLE 11:

- PIN 1. SOURCE 1
- 2. DRAIN 2
- 3. DRAIN 2
- 4. SOURCE 2
- 5. GATE 1
- 6. DRAIN 1/GATE 2

STYLE 12:

- PIN 1. I/O
- 2. GROUND
- 3. I/O
- 4. I/O
- 5. VCC
- 6. I/O

STYLE 13:

- PIN 1. GATE 1
- 2. SOURCE 2
- 3. GATE 2
- 4. DRAIN 2
- 5. SOURCE 1
- 6. DRAIN 1

STYLE 14:

- PIN 1. ANODE
- 2. SOURCE
- 3. GATE
- 4. CATHODE/DRAIN
- 5. CATHODE/DRAIN
- 6. CATHODE/DRAIN

STYLE 15:

- PIN 1. ANODE
- 2. SOURCE
- 3. GATE
- 4. DRAIN
- 5. N/C
- 6. CATHODE

STYLE 16:

- PIN 1. ANODE/CATHODE
- 2. BASE
- 3. EMITTER
- 4. COLLECTOR
- 5. ANODE
- 6. CATHODE

STYLE 17:

- PIN 1. EMITTER
- 2. BASE
- 3. ANODE/CATHODE
- 4. ANODE
- 5. CATHODE
- 6. COLLECTOR

DOCUMENT NUMBER:	98ASB14888C	Electronic versions are uncontrolled except when accessed directly from the Document Repository. Printed versions are uncontrolled except when stamped "CONTROLLED COPY" in red.
DESCRIPTION:	TSOP-6 3.00x1.50x0.90, 0.95P	PAGE 2 OF 2

onsemi and onsemi are trademarks of Semiconductor Components Industries, LLC dba onsemi or its subsidiaries in the United States and/or other countries. onsemi reserves the right to make changes without further notice to any products herein. onsemi makes no warranty, representation or guarantee regarding the suitability of its products for any particular purpose, nor does onsemi assume any liability arising out of the application or use of any product or circuit, and specifically disclaims any and all liability, including without limitation special, consequential or incidental damages. onsemi does not convey any license under its patent rights nor the rights of others.

onsemi, **Onsemi**, and other names, marks, and brands are registered and/or common law trademarks of Semiconductor Components Industries, LLC dba "**onsemi**" or its affiliates and/or subsidiaries in the United States and/or other countries. **onsemi** owns the rights to a number of patents, trademarks, copyrights, trade secrets, and other intellectual property. A listing of **onsemi**'s product/patent coverage may be accessed at www.onsemi.com/site/pdf/Patent-Marking.pdf. **onsemi** reserves the right to make changes at any time to any products or information herein, without notice. The information herein is provided "as-is" and **onsemi** makes no warranty, representation or guarantee regarding the accuracy of the information, product features, availability, functionality, or suitability of its products for any particular purpose, nor does **onsemi** assume any liability arising out of the application or use of any product or circuit, and specifically disclaims any and all liability, including without limitation special, consequential or incidental damages. Buyer is responsible for its products and applications using **onsemi** products, including compliance with all laws, regulations and safety requirements or standards, regardless of any support or applications information provided by **onsemi**. "Typical" parameters which may be provided in **onsemi** data sheets and/or specifications can and do vary in different applications and actual performance may vary over time. All operating parameters, including "Typicals" must be validated for each customer application by customer's technical experts. **onsemi** does not convey any license under any of its intellectual property rights nor the rights of others. **onsemi** products are not designed, intended, or authorized for use as a critical component in life support systems or any FDA Class 3 medical devices or medical devices with a same or similar classification in a foreign jurisdiction or any devices intended for implantation in the human body. Should Buyer purchase or use **onsemi** products for any such unintended or unauthorized application, Buyer shall indemnify and hold **onsemi** and its officers, employees, subsidiaries, affiliates, and distributors harmless against all claims, costs, damages, and expenses, and reasonable attorney fees arising out of, directly or indirectly, any claim of personal injury or death associated with such unintended or unauthorized use, even if such claim alleges that **onsemi** was negligent regarding the design or manufacture of the part. **onsemi** is an Equal Opportunity/Affirmative Action Employer. This literature is subject to all applicable copyright laws and is not for resale in any manner.

ADDITIONAL INFORMATION

TECHNICAL PUBLICATIONS:

Technical Library: www.onsemi.com/design/resources/technical-documentation
onsemi Website: www.onsemi.com

ONLINE SUPPORT: www.onsemi.com/support

For additional information, please contact your local Sales Representative at www.onsemi.com/support/sales