

# Bipolar Transistor (-)50 V, (-)3 A, Low $V_{CE(sat)}$ , (PNP)NPN Single

## NSVS50030SB3, NSVS50031SB3

This device is bipolar junction transistor featuring high current, low saturation voltage, and high speed switching.

Suitable for motor driver, relay driver, DC-DC converter of automotive applications. AEC-Q101 qualified and PPAP capable.

### Features

- Large Current Capacitance
- Low Collector to Emitter Saturation Voltage
- High-Speed Switching
- High Allowable Power Dissipation
- AEC-Q101 Qualified and PPAP Capable
- Pb-Free, Halogen Free and RoHS Compliance
- Ultra Small Package Facilitates Miniaturization in End Products (Mounting Height: 0.9 mm)

### Typical Applications

- DC / DC Converter
- Relay Drivers, Lamp Drivers, Motor Drivers
- Camera Flash

### Specifications

ABSOLUTE MAXIMUM RATINGS at  $T_A = 25^\circ\text{C}$

Parameter	Symbol	Value	Unit
Collector to Base Voltage	$V_{CBO}$	(-50) 100	V
Collector to Emitter Voltage	$V_{CES}$	(-50) 100	V
Collector to Emitter Voltage	$V_{CEO}$	(-)50	V
Emitter to Base Voltage	$V_{EBO}$	(-)6	V
Collector Current	$I_C$	(-)3	A
Collector Current (Pulse)	$I_{CP}$	(-)6	A
Base Current	$I_B$	(-)600	mA
Collector Dissipation (Note 1)	$P_C$	1.1	W
Junction Temperature	$T_j$	175	$^\circ\text{C}$
Storage Temperature	$T_{stg}$	-55 to +175	$^\circ\text{C}$

Stresses exceeding those listed in the Maximum Ratings table may damage the device. If any of these limits are exceeded, device functionality should not be assumed, damage may occur and reliability may be affected.

1. Surface mounted on ceramic substrate. (600 mm<sup>2</sup> x 0.8 mm)

### ELECTRICAL CONNECTION

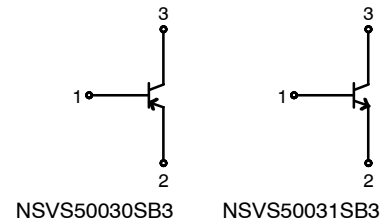

CPH3  
CASE 318BA

### MARKING DIAGRAMS

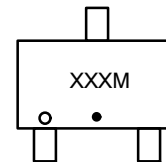

XXX = HAE: NSVS50030SB3  
= HCE: NSVS50031SB3  
M = Single Digit Date Code

### ORDERING INFORMATION

See detailed ordering and shipping information on page 2 of this data sheet.

# NSVS50030SB3, NSVS50031SB3

## ORDERING INFORMATION

Device	Marking	Package	Shipping (Qty / Packing) †
NSVS50030SB3T1G	HAE	CPH3 (Pb-Free / Halogen Free)	3,000/ Tape & Reel
NSVS50031SB3T1G	HCE		

†For information on tape and reel specifications, including part orientation and tape sizes, please refer to our Tape and Reel Packaging Specification Brochure, BRD8011/D.

## ELECTRICAL CHARACTERISTICS (T<sub>C</sub> = 25°C unless otherwise noted)

Parameter	Symbol	Conditions	Value			Unit
			Min	Typ	Max	
Collector Cutoff Current	I <sub>CBO</sub>	V <sub>CB</sub> = (-)40 V, I <sub>E</sub> = 0 A			(-)1	μA
Emitter Cutoff Current	I <sub>EBO</sub>	V <sub>EB</sub> = (-)4 V, I <sub>C</sub> = 0 A			(-)1	μA
DC Current Gain	h <sub>FE</sub>	V <sub>CE</sub> = (-)2 V, I <sub>C</sub> = (-)100 mA	200		560	
Gain-Bandwidth Product	f <sub>T</sub>	V <sub>CE</sub> = (-)10 V, I <sub>C</sub> = (-)500 mA		(360) 380		MHz
Output Capacitance	C <sub>ob</sub>	V <sub>CB</sub> = (-)10 V, f = 1 MHz		(24) 13		pF
Collector to Emitter Saturation Voltage	V <sub>CE(sat)</sub>	I <sub>C</sub> = (-)1 A, I <sub>B</sub> = (-)50 mA		(-100) 80	(-200) 120	mV
		I <sub>C</sub> = (-)2 A, I <sub>B</sub> = (-)100 mA		(-185) 140	(-500) 210	mV
Base to Emitter Saturation Voltage	V <sub>BE(sat)</sub>	I <sub>C</sub> = (-)2 A, I <sub>B</sub> = (-)100 mA		(-)0.88	(-)1.2	V
Collector to Base Breakdown Voltage	V <sub>(BR)CBO</sub>	I <sub>C</sub> = (-)10 μA, I <sub>E</sub> = 0 A	(-50) 100			V
Collector to Emitter Breakdown Voltage	V <sub>(BR)CES</sub>	I <sub>C</sub> = (-)100 μA, R <sub>BE</sub> = 0 Ω	(-50) 100			V
Collector to Emitter Breakdown Voltage	V <sub>(BR)CEO</sub>	I <sub>C</sub> = (-)1 mA, R <sub>BE</sub> = ∞	(-)50			V
Emitter to Base Breakdown Voltage	V <sub>(BR)EBO</sub>	I <sub>E</sub> = (-)10 μA, I <sub>C</sub> = 0 A	(-)6			V
Turn-On Time	t <sub>on</sub>	See Fig.1		(30) 35		ns
Storage Time	t <sub>stg</sub>			(230) 300		ns
Fall Time	t <sub>f</sub>			(15) 22		ns

Product parametric performance is indicated in the Electrical Characteristics for the listed test conditions, unless otherwise noted. Product performance may not be indicated by the Electrical Characteristics if operated under different conditions.

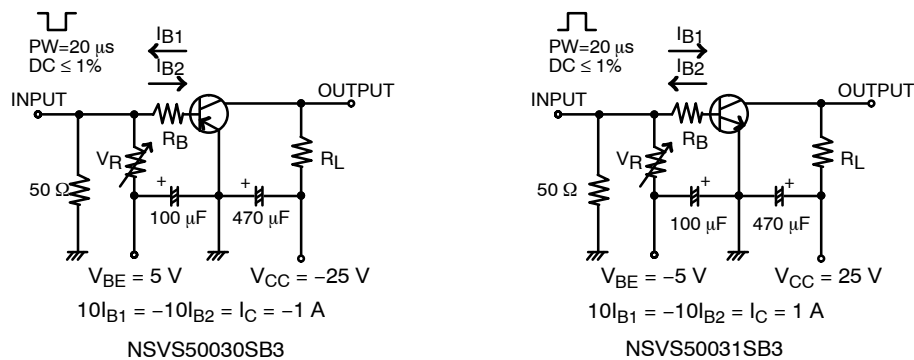

**Figure 1. Switching Time Test Circuit**

# NSVS50030SB3, NSVS50031SB3

## TYPICAL PERFORMANCE CHARACTERISTICS

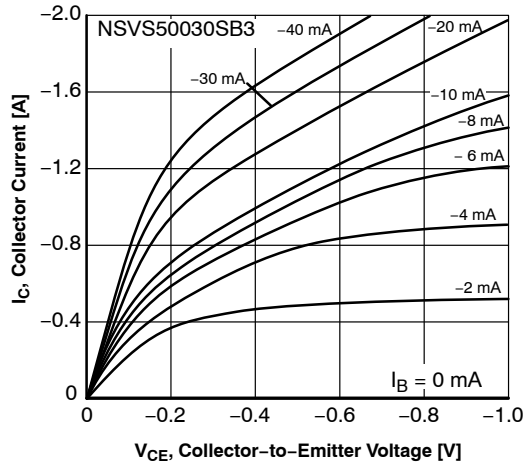

Figure 2.  $I_C - V_{CE}$

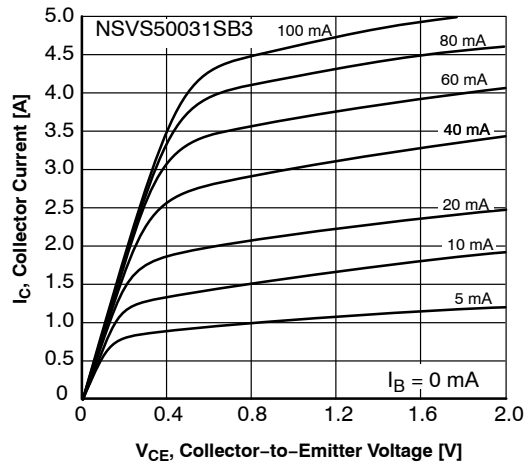

Figure 3.  $I_C - V_{CE}$

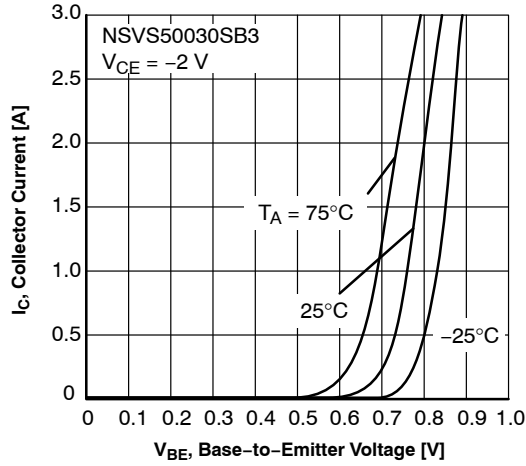

Figure 4.  $I_C - V_{BE}$

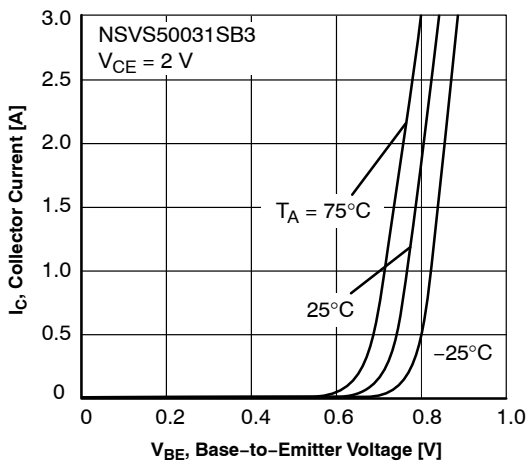

Figure 5.  $I_C - V_{BE}$

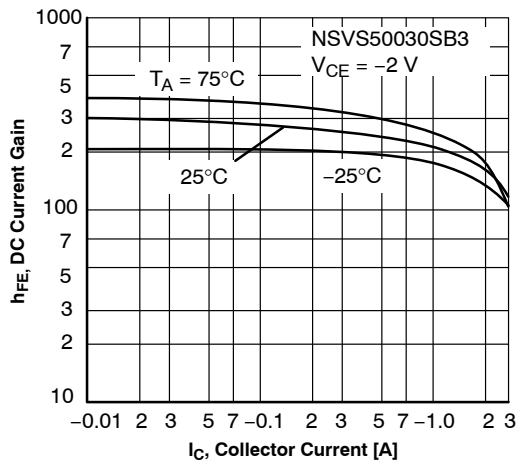

Figure 6.  $h_{FE} - I_C$

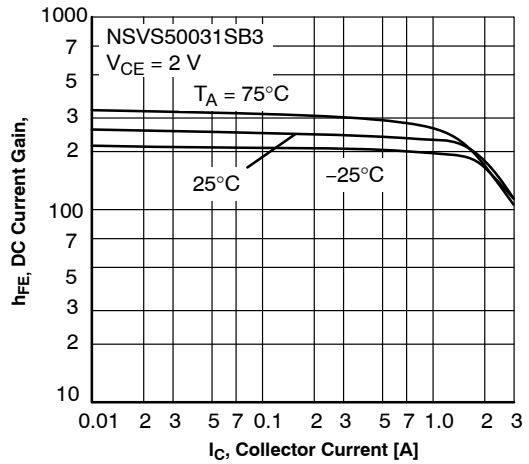

Figure 7.  $h_{FE} - I_C$

# NSVS50030SB3, NSVS50031SB3

## TYPICAL PERFORMANCE CHARACTERISTICS (CONTINUED)

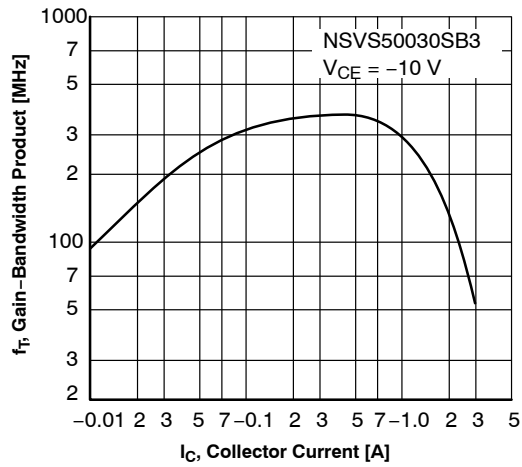

Figure 8.  $f_T - I_C$

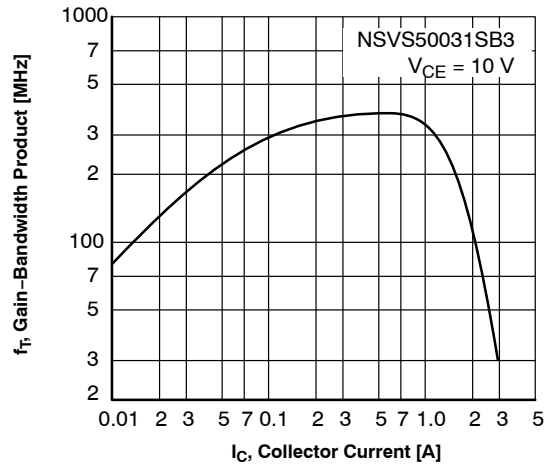

Figure 9.  $f_T - I_C$

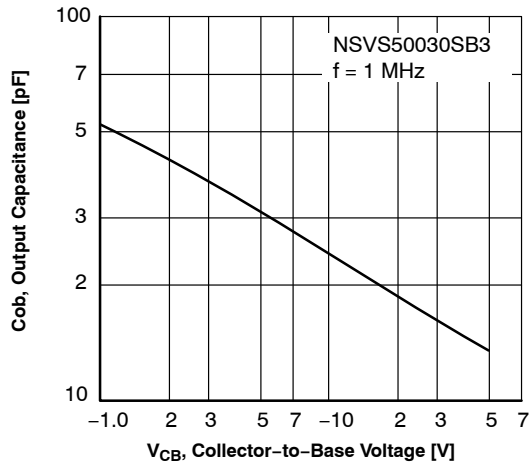

Figure 10.  $C_{ob} - V_{CB}$

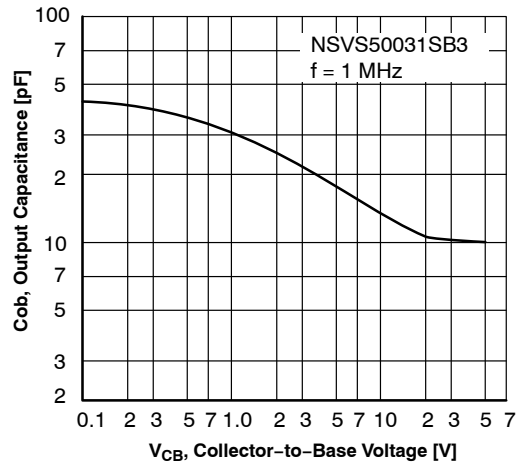

Figure 11.  $C_{ob} - V_{CB}$

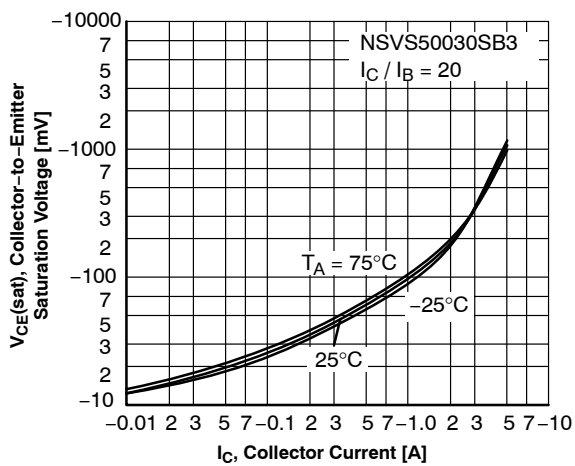

Figure 12.  $V_{CE(sat)} - I_C$

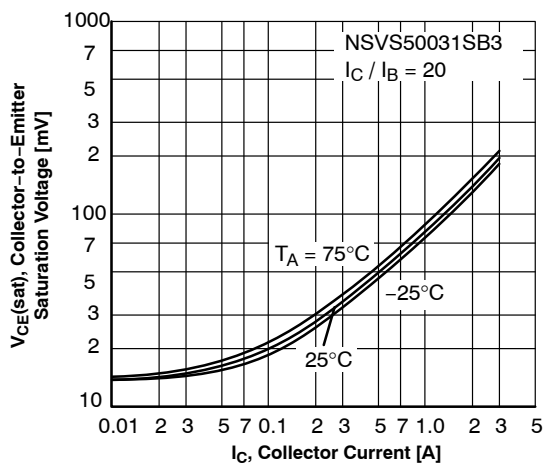

Figure 13.  $V_{CE(sat)} - I_C$

# NSVS50030SB3, NSVS50031SB3

## TYPICAL PERFORMANCE CHARACTERISTICS (CONTINUED)

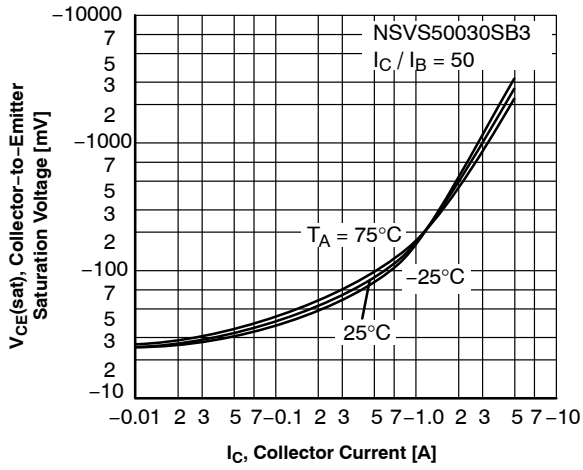

Figure 14.  $V_{CE(sat)} - I_C$

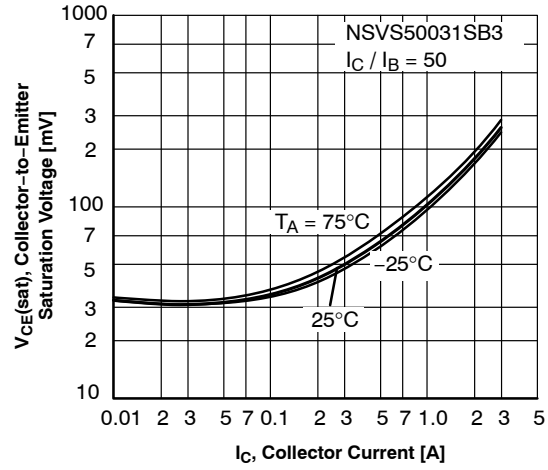

Figure 15.  $V_{CE(sat)} - I_C$

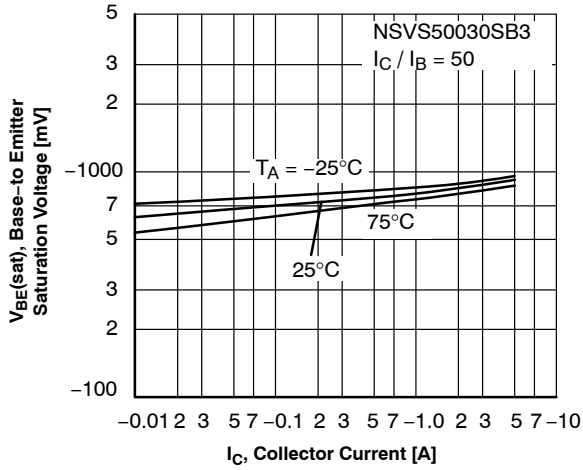

Figure 16.  $V_{BE(sat)} - I_C$

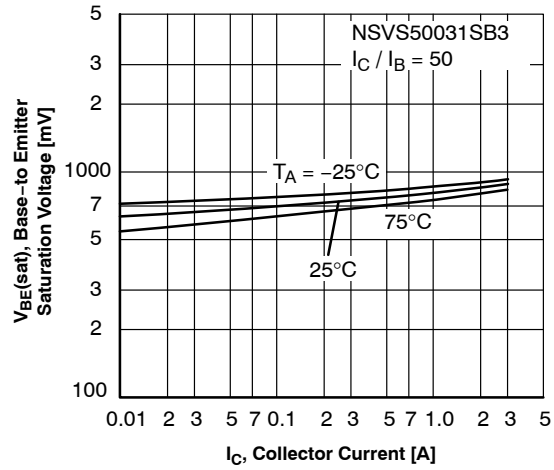

Figure 17.  $V_{BE(sat)} - I_C$

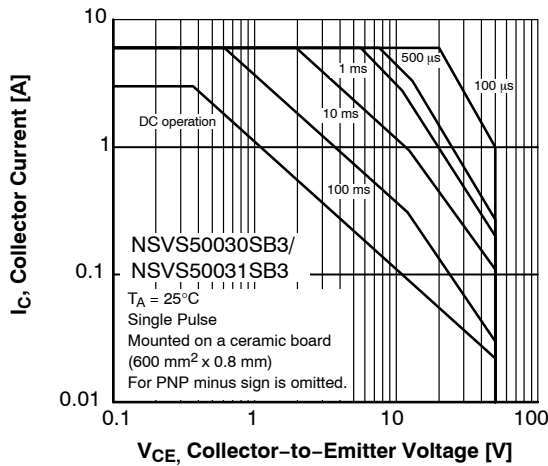

Figure 18. ASO

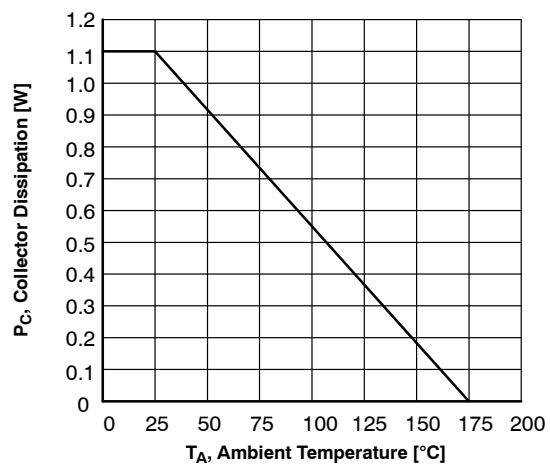
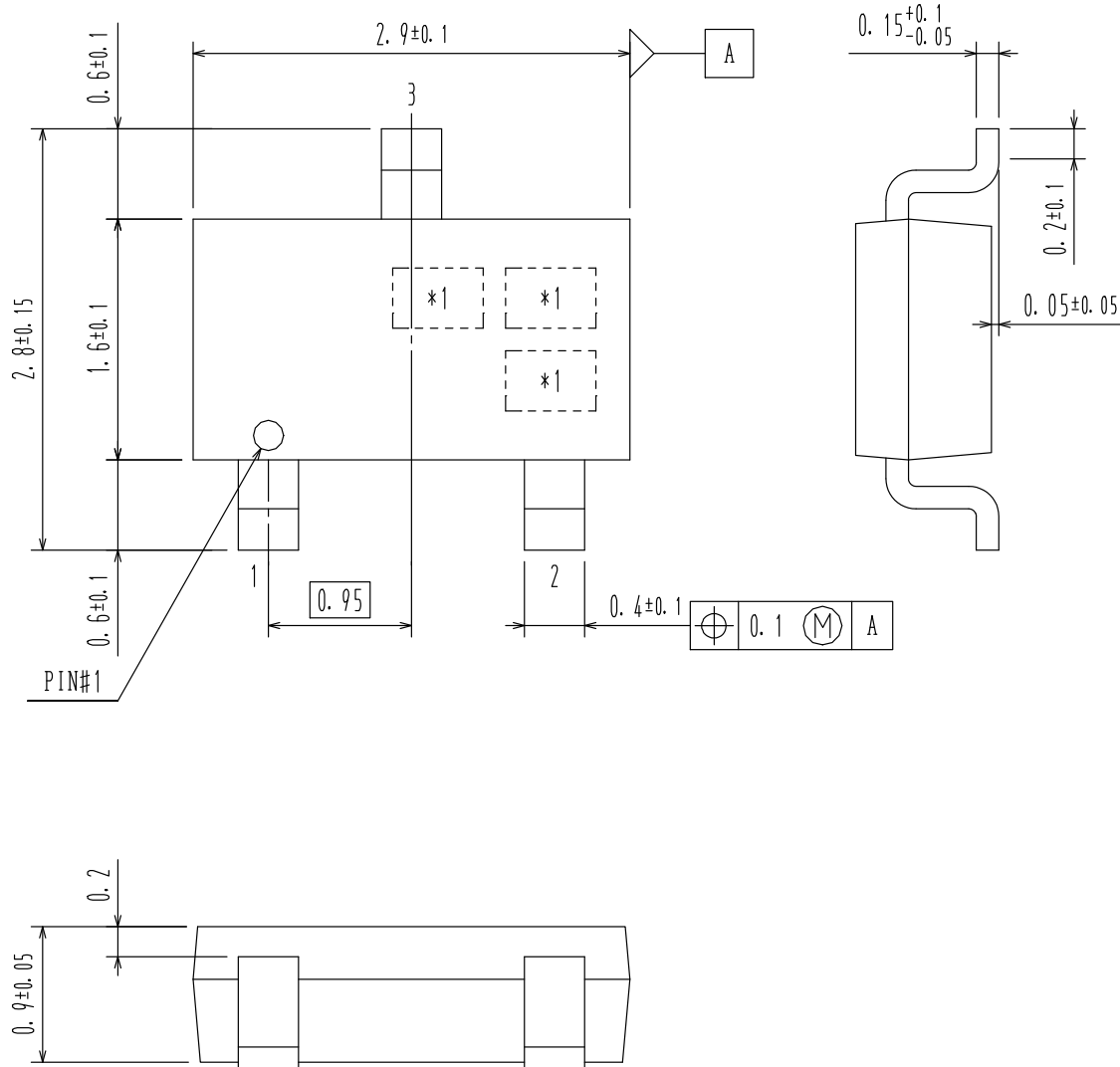

Figure 19.  $P_C - T_A$

**CPH3**  
**CASE 318BA**  
**ISSUE O**

DATE 30 NOV 2011



<b>DOCUMENT NUMBER:</b>	<b>98AON65437E</b>	Electronic versions are uncontrolled except when accessed directly from the Document Repository. Printed versions are uncontrolled except when stamped "CONTROLLED COPY" in red.
<b>DESCRIPTION:</b>	<b>CPH3</b>	<b>PAGE 1 OF 1</b>

ON Semiconductor and are trademarks of Semiconductor Components Industries, LLC dba ON Semiconductor or its subsidiaries in the United States and/or other countries. ON Semiconductor reserves the right to make changes without further notice to any products herein. ON Semiconductor makes no warranty, representation or guarantee regarding the suitability of its products for any particular purpose, nor does ON Semiconductor assume any liability arising out of the application or use of any product or circuit, and specifically disclaims any and all liability, including without limitation special, consequential or incidental damages. ON Semiconductor does not convey any license under its patent rights nor the rights of others.

**onsemi**, **Onsemi**, and other names, marks, and brands are registered and/or common law trademarks of Semiconductor Components Industries, LLC dba "**onsemi**" or its affiliates and/or subsidiaries in the United States and/or other countries. **onsemi** owns the rights to a number of patents, trademarks, copyrights, trade secrets, and other intellectual property. A listing of **onsemi**'s product/patent coverage may be accessed at [www.onsemi.com/site/pdf/Patent-Marking.pdf](http://www.onsemi.com/site/pdf/Patent-Marking.pdf). **onsemi** reserves the right to make changes at any time to any products or information herein, without notice. The information herein is provided "as-is" and **onsemi** makes no warranty, representation or guarantee regarding the accuracy of the information, product features, availability, functionality, or suitability of its products for any particular purpose, nor does **onsemi** assume any liability arising out of the application or use of any product or circuit, and specifically disclaims any and all liability, including without limitation special, consequential or incidental damages. Buyer is responsible for its products and applications using **onsemi** products, including compliance with all laws, regulations and safety requirements or standards, regardless of any support or applications information provided by **onsemi**. "Typical" parameters which may be provided in **onsemi** data sheets and/or specifications can and do vary in different applications and actual performance may vary over time. All operating parameters, including "Typicals" must be validated for each customer application by customer's technical experts. **onsemi** does not convey any license under any of its intellectual property rights nor the rights of others. **onsemi** products are not designed, intended, or authorized for use as a critical component in life support systems or any FDA Class 3 medical devices or medical devices with a same or similar classification in a foreign jurisdiction or any devices intended for implantation in the human body. Should Buyer purchase or use **onsemi** products for any such unintended or unauthorized application, Buyer shall indemnify and hold **onsemi** and its officers, employees, subsidiaries, affiliates, and distributors harmless against all claims, costs, damages, and expenses, and reasonable attorney fees arising out of, directly or indirectly, any claim of personal injury or death associated with such unintended or unauthorized use, even if such claim alleges that **onsemi** was negligent regarding the design or manufacture of the part. **onsemi** is an Equal Opportunity/Affirmative Action Employer. This literature is subject to all applicable copyright laws and is not for resale in any manner.

---

## ADDITIONAL INFORMATION

### TECHNICAL PUBLICATIONS:

Technical Library: [www.onsemi.com/design/resources/technical-documentation](http://www.onsemi.com/design/resources/technical-documentation)  
onsemi Website: [www.onsemi.com](http://www.onsemi.com)

### ONLINE SUPPORT: [www.onsemi.com/support](http://www.onsemi.com/support)

For additional information, please contact your local Sales Representative at [www.onsemi.com/support/sales](http://www.onsemi.com/support/sales)