

5.5 V Unidirectional ESD and Surge Protection Device

NSPU3051

The NSPU3051 is designed to protect voltage sensitive components from ESD. Excellent clamping capability, low leakage, high peak pulse current handling capability and fast response time provide best in class protection on designs that are exposed to ESD. Because of its small size, it is suited for use in cellular phones, tablets, MP3 players, digital cameras and many other portable applications where board space comes at a premium.

Features

- Low Clamping Voltage
- Low Leakage
- Small Body Outline: 1.0 mm x 0.6 mm
- Protection for the Following IEC Standards:
 - IEC61000-4-2 Level 4: ± 30 kV Contact Discharge
 - IEC61000-4-5 (Lightning): 36 A (8/20 μ s)
- These Devices are Pb-Free, Halogen Free/BFR Free and are RoHS Compliant

Typical Applications

- USB V_{BUS} and CC Line Protection
- Microphone Line Protection
- GPIO Protection

Table 1. MAXIMUM RATINGS

| Rating | Symbol | Value | Unit |
|--------------------------------------|-----------|-------------|--------------------|
| IEC 61000-4-2 (ESD) | Contact | ± 30 | kV |
| | Air | ± 30 | |
| Operating Junction Temperature Range | T_J | -65 to +150 | $^{\circ}\text{C}$ |
| Storage Temperature Range | T_{STG} | -65 to +150 | $^{\circ}\text{C}$ |
| Minimum Peak Pulse Current | I_{PP} | 36 | A |

Stresses exceeding those listed in the Maximum Ratings table may damage the device. If any of these limits are exceeded, device functionality should not be assumed, damage may occur and reliability may be affected.



ON Semiconductor[®]

www.onsemi.com



X2DFN2
CASE 714AB

MARKING DIAGRAM

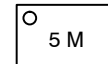

5 = Specific Device Code
M = Date Code

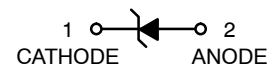

ORDERING INFORMATION

| Device | Package | Shipping [†] |
|---------------|------------------|-----------------------|
| NSPU3051N2T5G | X2DFN2 (Pb-Free) | 8000 / Tape & Reel |

[†]For information on tape and reel specifications, including part orientation and tape sizes, please refer to our Tape and Reel Packaging Specifications Brochure, BRD8011/D.

Table 2. ELECTRICAL CHARACTERISTICS

($T_A = 25^\circ\text{C}$ unless otherwise noted)

| Symbol | Parameter |
|-----------|---|
| I_{PP} | Maximum Reverse Peak Pulse Current |
| V_C | Clamping Voltage @ I_{PP} |
| V_{RWM} | Working Peak Reverse Voltage |
| I_R | Maximum Reverse Leakage Current @ V_{RWM} |
| V_{BR} | Breakdown Voltage @ I_T |
| I_T | Test Current |

*See Application Note AND8308/D for detailed explanations of datasheet parameters.

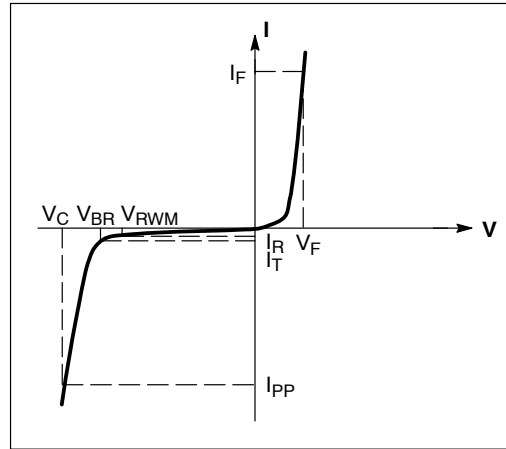

Uni-Directional Surge Protection

Table 3. ELECTRICAL CHARACTERISTICS ($T_A = 25^\circ\text{C}$ unless otherwise specified)

| Parameter | Symbol | Conditions | Min | Typ | Max | Unit |
|---|-----------|--|-------------------|-------|-----|---------------|
| Reverse Working Voltage | V_{RWM} | I/O Pin to GND | | | 5.5 | V |
| Breakdown Voltage | V_{BR} | $I_T = 1 \text{ mA}$, I/O Pin to GND | 5.7 | | 9.1 | V |
| Reverse Leakage Current | I_R | $V_{RWM} = 5.5 \text{ V}$, I/O Pin to GND | | | 0.1 | μA |
| Clamping Voltage (Note 1) | V_C | IEC61000-4-2, $\pm 8 \text{ kV}$ Contact | See Figures 2 & 3 | | | V |
| Clamping Voltage TLP (Note 2) | V_C | $I_{PP} = 8 \text{ A}$ IEC61000-4-2 Level 2 Equivalent ($\pm 4 \text{ kV}$ Contact, $\pm 8 \text{ kV}$ Air) | | 6.0 | | V |
| | | $I_{PP} = 16 \text{ A}$ IEC61000-4-2 Level 4 Equivalent ($\pm 8 \text{ kV}$ Contact, $\pm 15 \text{ kV}$ Air) | | 6.2 | | V |
| Reverse Peak Pulse Current | I_{PP} | IEC61000-4-5 (8x20 μs) per Figure 1 | 36 | | | A |
| Clamping Voltage 8x20 μs Waveform per Figure 1 | V_C | $I_{PP} = 36 \text{ A}$ | | 7.5 | 9.5 | V |
| Dynamic Resistance | R_{DYN} | 100 ns TLP | | 0.025 | | Ω |
| Junction Capacitance | C_J | $V_R = 0 \text{ V}$, $f = 1 \text{ MHz}$ | | 100 | 130 | pF |

Product parametric performance is indicated in the Electrical Characteristics for the listed test conditions, unless otherwise noted. Product performance may not be indicated by the Electrical Characteristics if operated under different conditions.

- For test procedure see application note AND8307/D
- ANSI/ESD STM5.5.1 – Electrostatic Discharge Sensitivity Testing using Transmission Line Pulse (TLP) Model.
TLP conditions: $Z_0 = 50 \Omega$, $t_p = 100 \text{ ns}$, $t_r = 1 \text{ ns}$, averaging window; $t_1 = 70 \text{ ns}$ to $t_2 = 90 \text{ ns}$.

TYPICAL CHARACTERISTICS

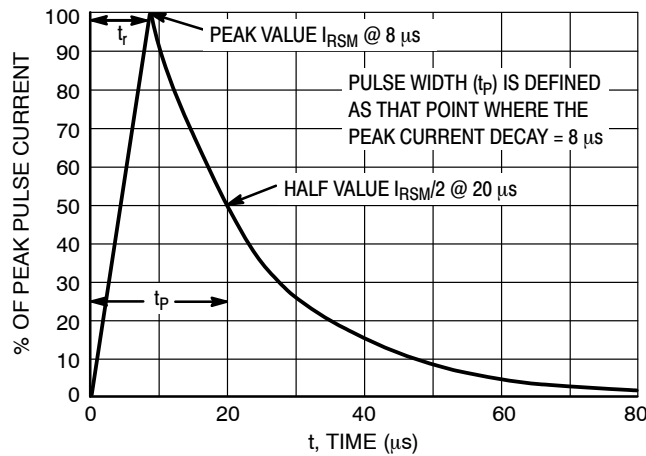

Figure 1. 8 x 20 μs Pulse Waveform

TYPICAL CHARACTERISTICS

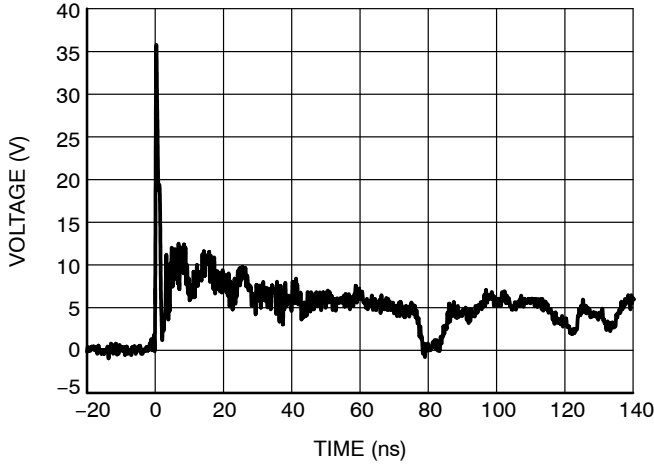

Figure 2. ESD Clamping Voltage
Positive 8 kV Contact per IEC61000-4-2

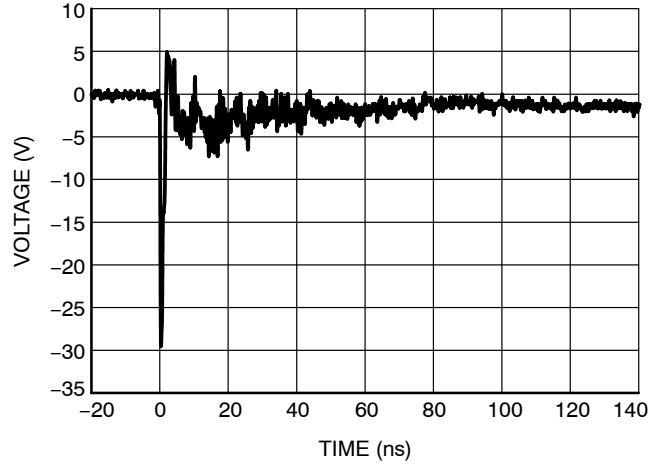

Figure 3. ESD Clamping Voltage
Negative 8 kV Contact per IEC61000-4-2

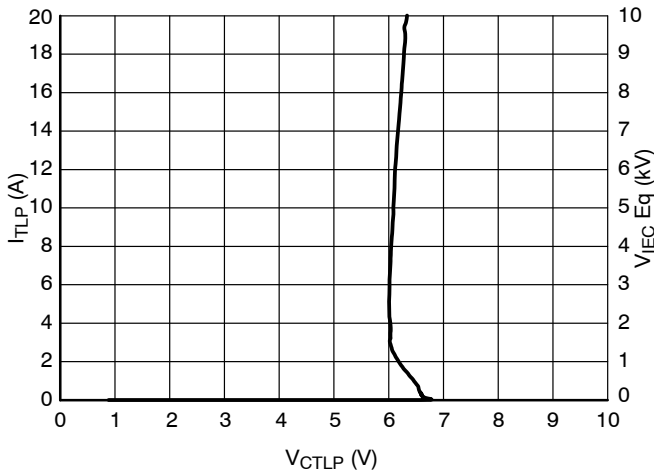

Figure 4. Positive TLP I-V Curve

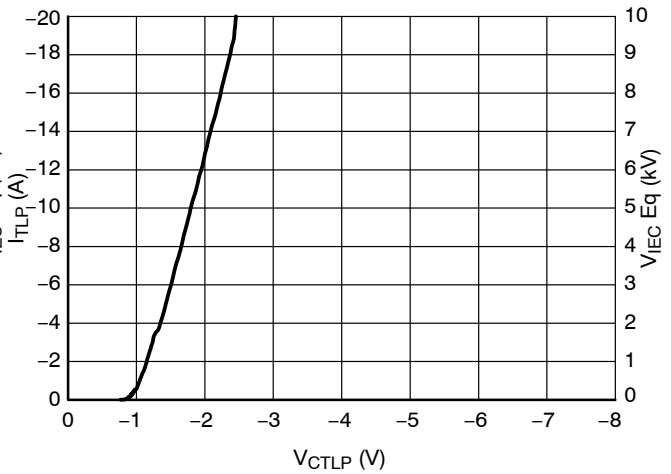

Figure 5. Negative TLP I-V Curve

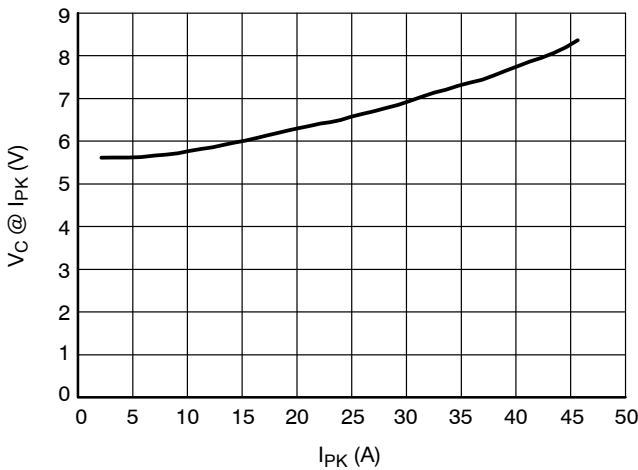

Figure 6. Positive Clamping Voltage vs. Peak
Pulse Current ($t_p = 8/20 \mu s$)

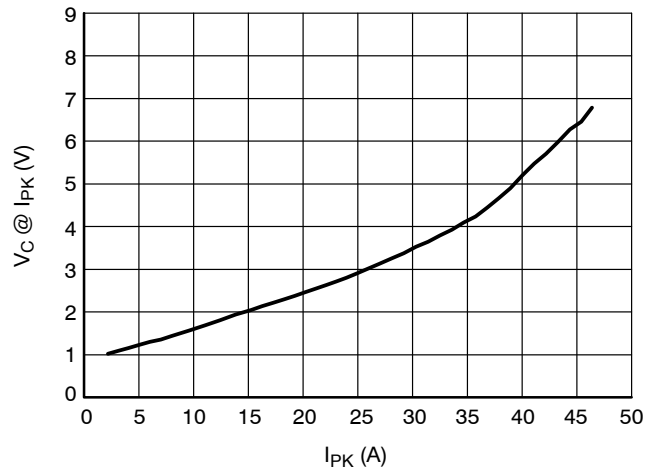

Figure 7. Negative Clamping Voltage vs. Peak
Pulse Current ($t_p = 8/20 \mu s$)

TYPICAL CHARACTERISTICS

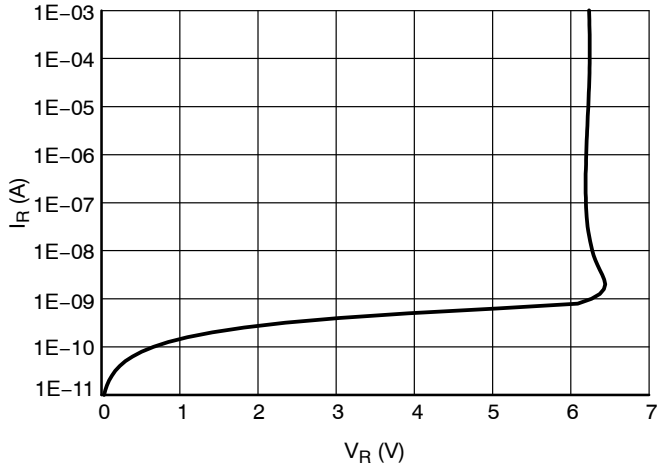

Figure 8. Breakdown Voltage

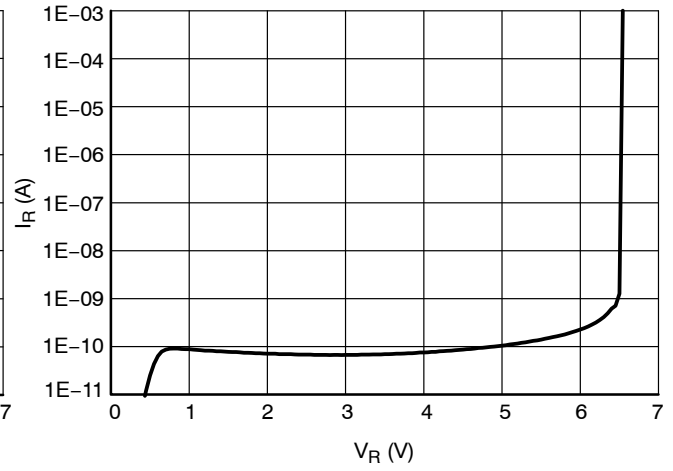

Figure 9. Reverse Leakage Current

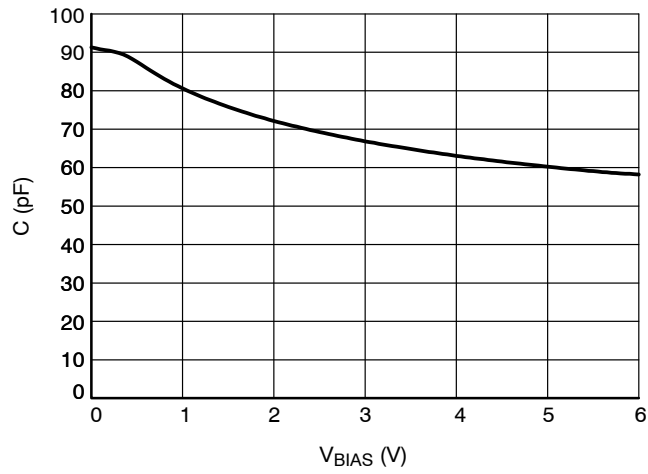

Figure 10. Line Capacitance, $f = 1$ MHz

Transmission Line Pulse (TLP) Measurement

Transmission Line Pulse (TLP) provides current versus voltage (I-V) curves in which each data point is obtained from a 100 ns long rectangular pulse from a charged transmission line. A simplified schematic of a typical TLP system is shown in Figure 11. TLP I-V curves of ESD protection devices accurately demonstrate the product’s ESD capability because the 10s of amps current levels and under 100 ns time scale match those of an ESD event. This is illustrated in Figure 12 where an 8 kV IEC 61000-4-2 current waveform is compared with TLP current pulses at 8 A and 16 A. A TLP I-V curve shows the voltage at which the device turns on as well as how well the device clamps voltage over a range of current levels. For more information on TLP measurements and how to interpret them please refer to AND9007/D.

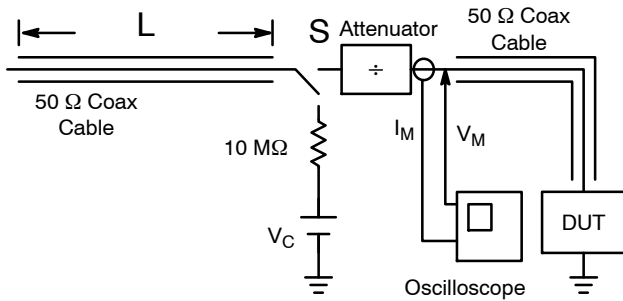

Figure 11. Simplified Schematic of a Typical TLP System

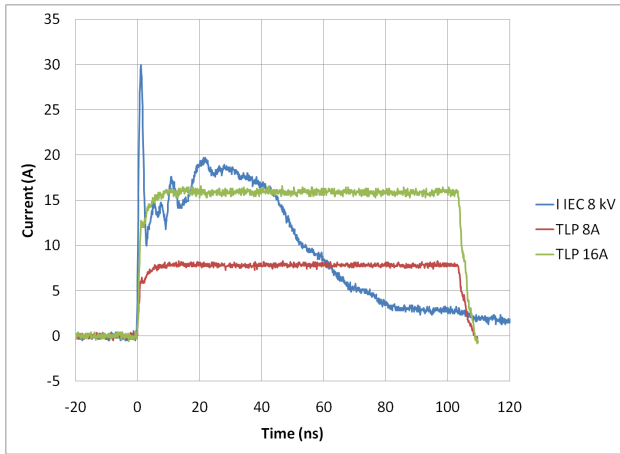

Figure 12. Comparison Between 8 kV IEC 61000-4-2 and 8 A and 16 A TLP Waveforms

ESD Voltage Clamping

For sensitive circuit elements it is important to limit the voltage that an IC will be exposed to during an ESD event to as low a voltage as possible. The ESD clamping voltage is the voltage drop across the ESD protection diode during an ESD event per the IEC61000-4-2 waveform. Since the IEC61000-4-2 was written as a pass/fail spec for larger systems such as cell phones or laptop computers it is not clearly defined in the spec how to specify a clamping voltage at the device level. ON Semiconductor has developed a way to examine the entire voltage waveform across the ESD protection diode over the time domain of an ESD pulse in the form of an oscilloscope screenshot, which can be found on the datasheets for all ESD protection diodes. For more information on how ON Semiconductor creates these screenshots and how to interpret them please refer to AND8307/D.

IEC 61000-4-2 Spec.

| Level | Test Voltage (kV) | First Peak Current (A) | Current at 30 ns (A) | Current at 60 ns (A) |
|-------|-------------------|------------------------|----------------------|----------------------|
| 1 | 2 | 7.5 | 4 | 2 |
| 2 | 4 | 15 | 8 | 4 |
| 3 | 6 | 22.5 | 12 | 6 |
| 4 | 8 | 30 | 16 | 8 |

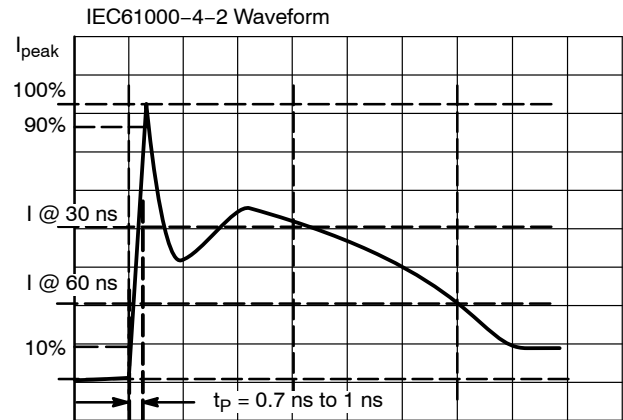

Figure 13. IEC61000-4-2 Spec

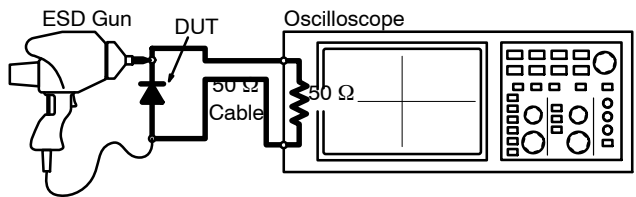
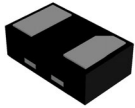

Figure 14. Diagram of ESD Test Setup

MECHANICAL CASE OUTLINE

PACKAGE DIMENSIONS



X2DFN2 1.00x0.60x0.37, 0.65P
CASE 714AB
ISSUE C

DATE 21 FEB 2024

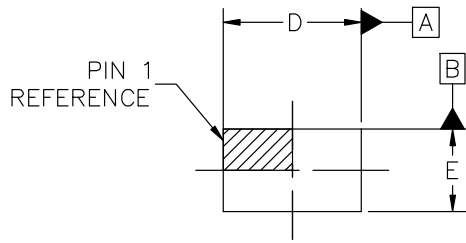

TOP VIEW

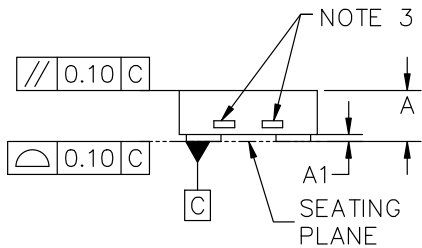

SIDE VIEW

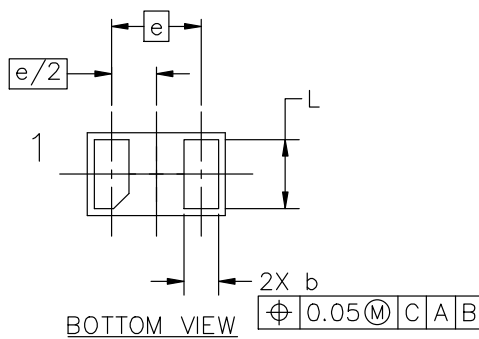

BOTTOM VIEW

NOTES:

1. DIMENSIONING AND TOLERANCING CONFORM TO ASME Y14.5-2018.
2. ALL DIMENSION ARE IN MILLIMETERS.
3. EXPOSED COPPER ALLOWED AS SHOW.

| DIM | MILLIMETERS | | |
|-----|-------------|------|-------|
| | MIN. | NOM. | MAX. |
| A | 0.34 | 0.37 | 0.40 |
| A1 | --- | 0.03 | 0.050 |
| b | 0.20 | 0.25 | 0.30 |
| D | 0.95 | 1.00 | 1.05 |
| E | 0.55 | 0.60 | 0.65 |
| e | 0.65 BSC | | |
| L | 0.45 | 0.50 | 0.55 |

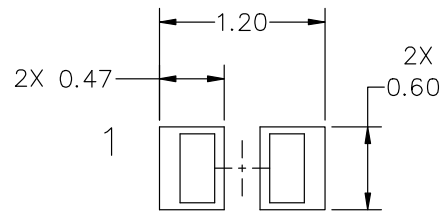

RECOMMENDED MOUNTING FOOTPRINT*

* FOR ADDITIONAL INFORMATION ON OUR Pb-FREE STRATEGY AND SOLDERING DETAILS, PLEASE DOWNLOAD THE ON SEMICONDUCTOR SOLDERING AND MOUNTING TECHNIQUES REFERENCE MANUAL, SOLDERRM/D.

GENERIC MARKING DIAGRAM*

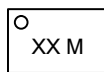

XX = Specific Device Code
M = Date Code

*This information is generic. Please refer to device data sheet for actual part marking. Pb-Free indicator, "G" or microdot "▪", may or may not be present. Some products may not follow the Generic Marking.

| | | |
|-------------------------|-------------------------------------|--|
| DOCUMENT NUMBER: | 98AON98172F | Electronic versions are uncontrolled except when accessed directly from the Document Repository. Printed versions are uncontrolled except when stamped "CONTROLLED COPY" in red. |
| DESCRIPTION: | X2DFN2 1.00x0.60x0.37, 0.65P | PAGE 1 OF 1 |

onsemi and ONSEMI are trademarks of Semiconductor Components Industries, LLC dba onsemi or its subsidiaries in the United States and/or other countries. onsemi reserves the right to make changes without further notice to any products herein. onsemi makes no warranty, representation or guarantee regarding the suitability of its products for any particular purpose, nor does onsemi assume any liability arising out of the application or use of any product or circuit, and specifically disclaims any and all liability, including without limitation special, consequential or incidental damages. onsemi does not convey any license under its patent rights nor the rights of others.

onsemi, **Onsemi**, and other names, marks, and brands are registered and/or common law trademarks of Semiconductor Components Industries, LLC dba "**onsemi**" or its affiliates and/or subsidiaries in the United States and/or other countries. **onsemi** owns the rights to a number of patents, trademarks, copyrights, trade secrets, and other intellectual property. A listing of **onsemi**'s product/patent coverage may be accessed at www.onsemi.com/site/pdf/Patent-Marking.pdf. **onsemi** reserves the right to make changes at any time to any products or information herein, without notice. The information herein is provided "as-is" and **onsemi** makes no warranty, representation or guarantee regarding the accuracy of the information, product features, availability, functionality, or suitability of its products for any particular purpose, nor does **onsemi** assume any liability arising out of the application or use of any product or circuit, and specifically disclaims any and all liability, including without limitation special, consequential or incidental damages. Buyer is responsible for its products and applications using **onsemi** products, including compliance with all laws, regulations and safety requirements or standards, regardless of any support or applications information provided by **onsemi**. "Typical" parameters which may be provided in **onsemi** data sheets and/or specifications can and do vary in different applications and actual performance may vary over time. All operating parameters, including "Typicals" must be validated for each customer application by customer's technical experts. **onsemi** does not convey any license under any of its intellectual property rights nor the rights of others. **onsemi** products are not designed, intended, or authorized for use as a critical component in life support systems or any FDA Class 3 medical devices or medical devices with a same or similar classification in a foreign jurisdiction or any devices intended for implantation in the human body. Should Buyer purchase or use **onsemi** products for any such unintended or unauthorized application, Buyer shall indemnify and hold **onsemi** and its officers, employees, subsidiaries, affiliates, and distributors harmless against all claims, costs, damages, and expenses, and reasonable attorney fees arising out of, directly or indirectly, any claim of personal injury or death associated with such unintended or unauthorized use, even if such claim alleges that **onsemi** was negligent regarding the design or manufacture of the part. **onsemi** is an Equal Opportunity/Affirmative Action Employer. This literature is subject to all applicable copyright laws and is not for resale in any manner.

ADDITIONAL INFORMATION

TECHNICAL PUBLICATIONS:

Technical Library: www.onsemi.com/design/resources/technical-documentation
onsemi Website: www.onsemi.com

ONLINE SUPPORT: www.onsemi.com/support

For additional information, please contact your local Sales Representative at www.onsemi.com/support/sales