

# Dual 5 A High Speed Low-Side MOSFET Drivers with Enable

## NCV81071

NCV81071 is a high speed dual low-side MOSFETs driver. It is capable of providing large peak currents into capacitive loads. This driver can deliver 5 A peak current at the Miller plateau region to help reduce the Miller effect during MOSFETs switching transition. This driver also provides enable functions to give users better control capability in different applications. ENA and ENB are implemented on pin 1 and pin 8 which were previously unused in the industry standard pin-out. They are internally pulled up to driver's input voltage for active high logic and can be left open for standard operations.

### Features

- High Current Drive Capability  $\pm 5$  A
- TTL/CMOS Compatible Inputs Independent of Supply Voltage
- Industry Standard Pin-out
- Enable Functions for Each Driver
- 8 ns Typical Rise and 8 ns Typical Fall Times with 1.8 nF Load
- Typical Propagation Delay Times of 20 ns with Input Falling and 20 ns with Input Rising
- Input Voltage from 4.5 V to 20 V
- Dual Outputs can be Paralleled for Higher Drive Current
- Fully Specified from  $-40^{\circ}\text{C}$  to  $+140^{\circ}\text{C}$
- AEC-Q100 Qualified and PPAP Capable
- These Devices are Pb-Free, Halogen Free/BFR Free and are RoHS Compliant

### Applications

- Server Power
- Telecommunication, Datacenter Power
- Synchronous Rectifier
- Switch Mode Power Supply
- DC/DC Converter
- Power Factor Correction
- Motor Drive
- Renewable Energy, Solar Inverter



ON Semiconductor®

[www.onsemi.com](http://www.onsemi.com)

### MARKING DIAGRAM



MSOP-8  
Z SUFFIX  
CASE 846AM

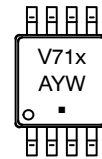

V71x = Specific Device Code  
x = A, B or C  
A = Assembly Location  
Y = Year  
W = Work Week  
▪ = Pb-Free Package

(Note: Microdot may be in either location)

### PIN CONNECTIONS

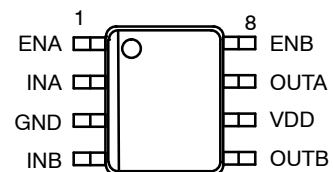

(Top View)

### ORDERING INFORMATION

See detailed ordering and shipping information in the package dimensions section on page 11 of this data sheet.

# NCV81071

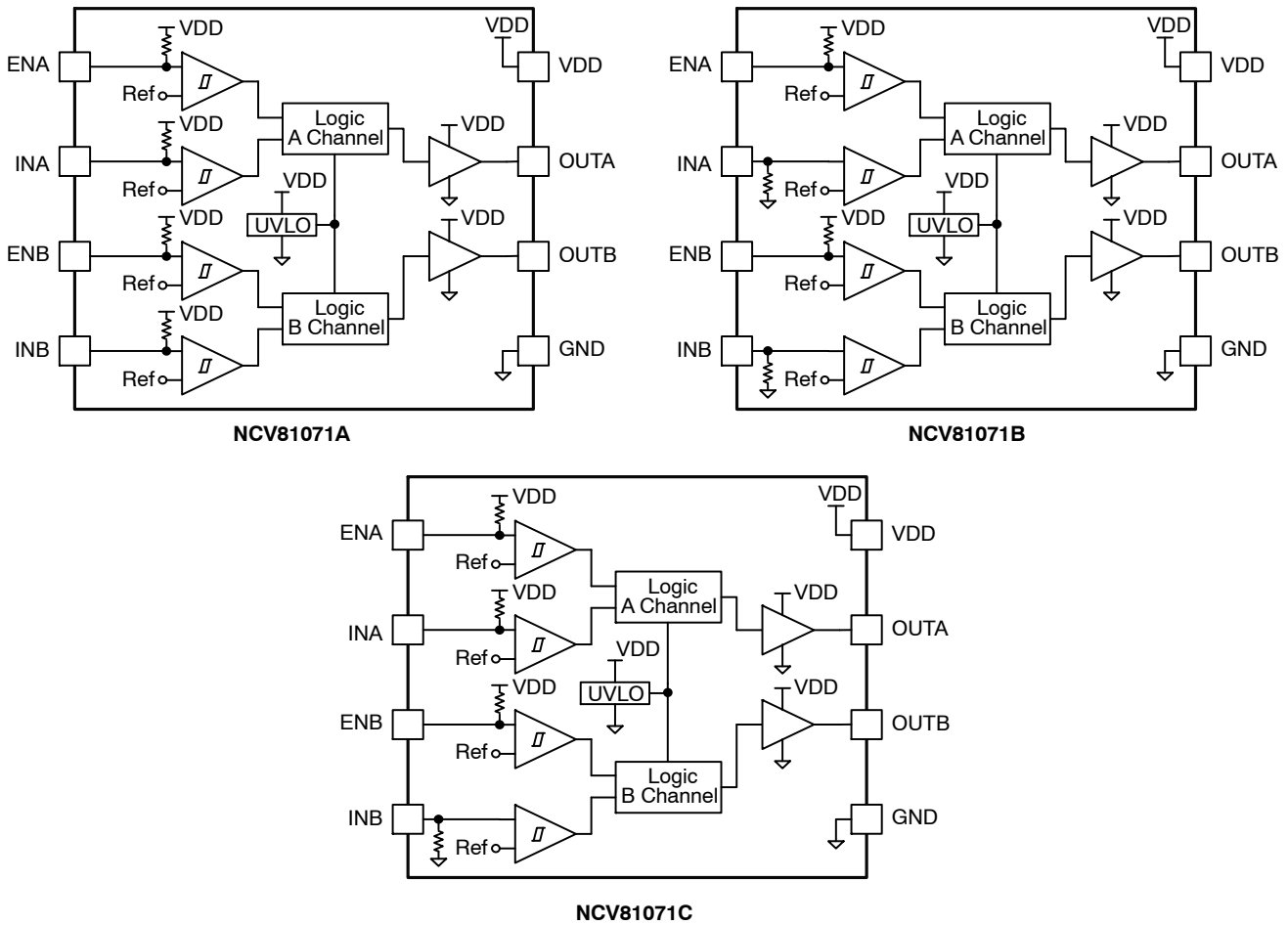

Figure 1. NCV81071 Block Diagram

Table 1. PIN DESCRIPTION

| Pin No. | Symbol | Description   |
|---------|--------|---|
| 1       | ENA    | Enable input for the driver channel A with logic compatible threshold and hysteresis. This pin is used to enable and disable the driver output. It is internally pulled up to VDD with a 200 kΩ resistor for active high operation. The output of the pin when the device is disabled will be always low. |
| 2       | INA    | Input of driver channel A which has logic compatible threshold and hysteresis. If not used, this pin should be connected to either VDD or GND. It should not be left unconnected.   |
| 3       | GND    | Common ground. This ground should be connected very closely to the source of the power MOSFET.  |
| 4       | INB    | Input of driver channel B which has logic compatible threshold and hysteresis. If not used, this pin should be connected to either VDD or GND. It should not be left unconnected.   |
| 5       | OUTB   | Output of driver channel B. The driver is able to provide 5 A drive current to the gate of the power MOSFET.  |
| 6       | VDD    | Supply voltage. Use this pin to connect the input power for the driver device.  |
| 7       | OUTA   | Output of driver channel A. The driver is able to provide 5 A drive current to the gate of the power MOSFET.  |
| 8       | ENB    | Enable input for the driver channel B with logic compatible threshold and hysteresis. This pin is used to enable and disable the driver output. It is internally pulled up to VDD with a 200 kΩ resistor for active high operation. The output of the pin when the device is disabled will be always low. |

# NCV81071

## TYPICAL APPLICATION CIRCUIT

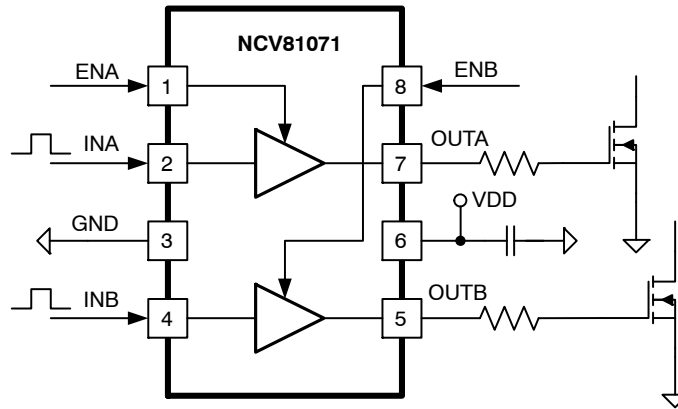

**Table 2. ABSOLUTE MAXIMUM RATINGS**

|                                 |                          | Value |         | Unit |
|---------------------------------|--------------------------|-------|---------|------|
|                                 |                          | Min   | Max     |      |
| Supply Voltage                  | VDD                      | -0.3  | 24      | V    |
| Output Current (DC)             | I <sub>out_dc</sub>      | 0.3   |         | A    |
| Output Current (Pulse < 0.5 μs) | I <sub>out_pulse</sub>   | 6.0   |         | A    |
| Input Voltage                   | INA, INB                 | -6.0  | VDD+0.3 | V    |
| Enable Voltage                  | ENA, ENB                 | -0.3  | VDD+0.3 |      |
| Output Voltage                  | OUTA, OUTB               | -0.3  | VDD+0.3 | V    |
| Junction Operation Temperature  | T <sub>J</sub>           | -40   | 150     | °C   |
| Storage Temperature             | T <sub>stg</sub>         | -65   | 160     |      |
| Electrostatic Discharge         | Human body model, HBM    | 5500  |         | V    |
|                                 | Charge device model, CDM | 2500  |         |      |
| OUTA OUTB Latch-up Protection   |                          | 500   |         | mA   |

Stresses exceeding those listed in the Maximum Ratings table may damage the device. If any of these limits are exceeded, device functionality should not be assumed, damage may occur and reliability may be affected.

**Table 3. RECOMMENDED OPERATING CONDITIONS**

| Parameter                  | Rating      | Unit |
|----------------------------|-------------|------|
| VDD supply Voltage         | 4.5 to 20   | V    |
| INA, INB input voltage     | -5.0 to VDD | V    |
| ENA, ENB input voltage     | 0 to VDD    | V    |
| Junction Temperature Range | -40 to +140 | °C   |

Functional operation above the stresses listed in the Recommended Operating Ranges is not implied. Extended exposure to stresses beyond the Recommended Operating Ranges limits may affect device reliability.

**Table 4. THERMAL INFORMATION**

| Package   | θ <sub>JA</sub> (°C/W) | θ <sub>JC</sub> (°C/W) | Ψ <sub>JT</sub> (°C/W) (Note 1) |
|-----------|------------------------|------------------------|---------------------------------|
| MSOP-8 EP | 39                     | 4.7                    | 11                              |

1. Ψ<sub>JT</sub>: approximate thermal impedance, junction-to-case top.

# NCV81071

**Table 5. INPUT/OUTPUT TABLE**

| ENA        | ENB        | INA        | INB        | NCV81071A |      | NCV81071B |      | NCV81071C |      |
|------------|------------|------------|------------|-----------|------|-----------|------|-----------|------|
|            |            |            |            | OUTA      | OUTB | OUTA      | OUTB | OUTA      | OUTB |
| H          | H          | L          | L          | H         | H    | L         | L    | H         | L    |
| H          | H          | L          | H          | H         | L    | L         | H    | H         | H    |
| H          | H          | H          | L          | L         | H    | H         | L    | L         | L    |
| H          | H          | H          | H          | L         | L    | H         | H    | L         | H    |
| L          | L          | Any        | Any        | L         | L    | L         | L    | L         | L    |
| Any        | Any        | x (Note 2) | x (Note 2) | L         | L    | L         | L    | L         | L    |
| x (Note 2) | x (Note 2) | L          | L          | H         | H    | L         | L    | H         | L    |
| x (Note 2) | x (Note 2) | L          | H          | H         | L    | L         | H    | H         | H    |
| x (Note 2) | x (Note 2) | H          | L          | L         | H    | H         | L    | L         | L    |
| x (Note 2) | x (Note 2) | H          | H          | L         | L    | H         | H    | L         | H    |

2. Floating condition, internal resistive pull up or pull down configures output condition

## PRODUCT MATRIX

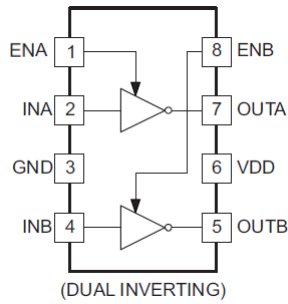

NCV81071A

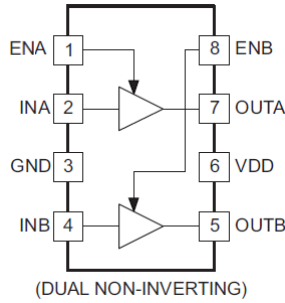

NCV81071B

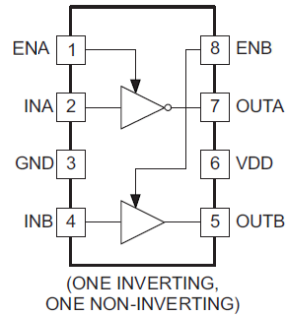

NCV81071C

# NCV81071

**Table 6. ELECTRICAL CHARACTERISTICS**

(Typical values:  $V_{DD} = 12\text{ V}$ ,  $1\ \mu\text{F}$  from  $V_{DD}$  to GND,  $T_A = T_J = -40^\circ\text{C}$  to  $140^\circ\text{C}$ , typical at  $T_{AMB} = 25^\circ\text{C}$ , unless otherwise specified)

| Parameter  | Symbol    | Test Conditions  | Min | Typ | Max | Units         |
|--|-----------|--|-----|-----|-----|---------------|
| <b>SUPPLY VOLTAGE</b>                              |           |  |     |     |     |               |
| VDD Under Voltage Lockout (rising)                 | $V_{CCR}$ | VDD rising   | 3.5 | 4.0 | 4.5 | V             |
| VDD Under Voltage Lockout (hysteresis)             | $V_{CCH}$ |  |     | 400 |     | mV            |
| Operating Current (no switching)                   | $I_{DD}$  | INA = 0, INB = 5 V, ENA = ENB = 0<br>INA = 5 V, INB = 0, ENA = ENB = 0<br>INA = 0, INB = 5 V, ENA = ENB = 5 V<br>INA = 5 V, INB = 0, ENA = ENB = 5 V |     | 1.4 | 3   | mA            |
| VDD Under Voltage Lockout to Output Delay (Note 3) |           | VDD rising   |     | 10  |     | $\mu\text{s}$ |

## INPUTS

|                               |           |                                      |     |     |     |            |
|-------------------------------|-----------|--------------------------------------|-----|-----|-----|------------|
| High Threshold                | $V_{thH}$ | Input rising from logic low          | 1.8 | 2.0 | 2.2 | V          |
| Low Threshold                 | $V_{thL}$ | Input falling from logic high        | 0.8 | 1.0 | 1.2 | V          |
| INA, INB Pull-Up Resistance   |           | OUTA = OUTB = Inverter Configuration |     | 200 |     | k $\Omega$ |
| INA, INB Pull-Down Resistance |           | OUTA = OUTB = Buffer Configuration   |     | 200 |     | k $\Omega$ |

## OUTPUTS

|  |              |                                   |  |     |   |          |
|--|--------------|-----------------------------------|--|-----|---|----------|
| Output Resistance High                 | $R_{OH}$     | IOU <sub>T</sub> = -10 mA         |  | 0.8 | 2 | $\Omega$ |
| Output Resistance Low                  | $R_{OL}$     | IOU <sub>T</sub> = +10 mA         |  | 0.8 | 2 | $\Omega$ |
| Peak Source Current (Note 4)           | $I_{Source}$ | OUTA/OUTB = GND<br>200 ns Pulse   |  | 5   |   | A        |
| Miller Plateau Source Current (Note 4) | $I_{Source}$ | OUTA/OUTB = 5.0 V<br>200 ns Pulse |  | 4.5 |   | A        |
| Peak Sink Current (Note 4)             | $I_{Sink}$   | OUTA/OUTB = VDD<br>200 ns Pulse   |  | 5   |   | A        |
| Miller Plateau Sink Current (Note 4)   | $I_{Sink}$   | OUTA/OUTB = 5.0 V<br>200 ns Pulse |  | 3.5 |   | A        |

## ENABLE

|   |             |                            |     |     |     |            |
|---|-------------|----------------------------|-----|-----|-----|------------|
| High-Level Input Voltage                        | $V_{IN\_H}$ | Low to High Transition     | 1.8 | 2.0 | 2.2 | V          |
| Low-Level Input Voltage                         | $V_{IN\_L}$ | High to Low Transition     | 0.8 | 1.0 | 1.2 | V          |
| ENA, ENB pull-up resistance                     |             |                            |     | 200 |     | k $\Omega$ |
| Propagation Delay Time (EN to OUT) (Notes 3, 5) | $t_{d3}$    | $C_{Load} = 1.8\text{ nF}$ | 16  | 20  | 29  | ns         |
| Propagation Delay Time (EN to OUT) (Notes 3, 5) | $t_{d4}$    | $C_{Load} = 1.8\text{ nF}$ | 16  | 20  | 29  | ns         |

## SWITCHING CHARACTERISTICS

|   |          |  |    |    |    |    |
|---|----------|--|----|----|----|----|
| Propagation Delay Time Low to High, IN Rising (IN to OUT) (Notes 3, 5)  | $t_{d1}$ | $C_{Load} = 1.8\text{ nF}$                       | 16 | 20 | 29 | ns |
| Propagation Delay Time High to Low, IN Falling (IN to OUT) (Notes 3, 5) | $t_{d2}$ | $C_{Load} = 1.8\text{ nF}$                       | 16 | 20 | 29 | ns |
| Rise Time (Note 5)  | $t_r$    | $C_{Load} = 1.8\text{ nF}$                       |    | 8  | 15 | ns |
| Fall Time (Note 5)  | $t_f$    | $C_{Load} = 1.8\text{ nF}$                       |    | 8  | 15 | ns |
| Delay Matching between 2 Channels (Note 6)                              | $t_m$    | INA = INB, OUTA and OUTB at 50% Transition Point |    | 1  | 4  | ns |

Product parametric performance is indicated in the Electrical Characteristics for the listed test conditions, unless otherwise noted. Product performance may not be indicated by the Electrical Characteristics if operated under different conditions.

3. Guaranteed by design.

4. Not production tested, guaranteed by design and statistical analysis.

5. See timing diagrams in Figure 2, Figure 3, Figure 4 and Figure 5.

6. Guaranteed by characterization.

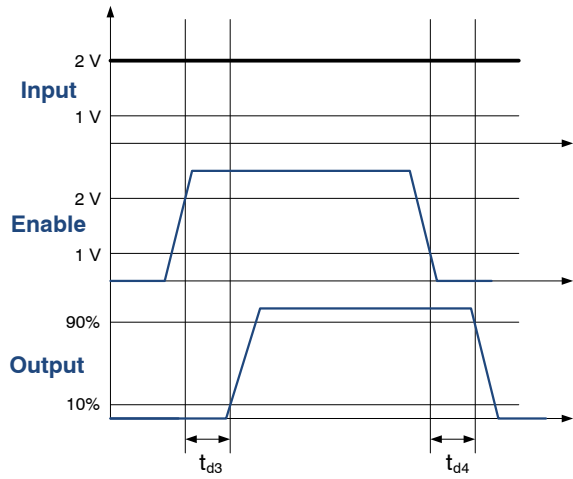

Figure 2. Enable Function for Non-inverting Input Driver Operation

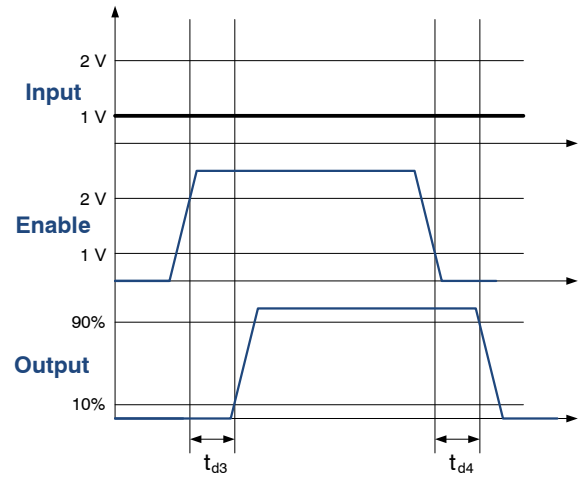

Figure 3. Enable Function for Inverting Input Driver Operation

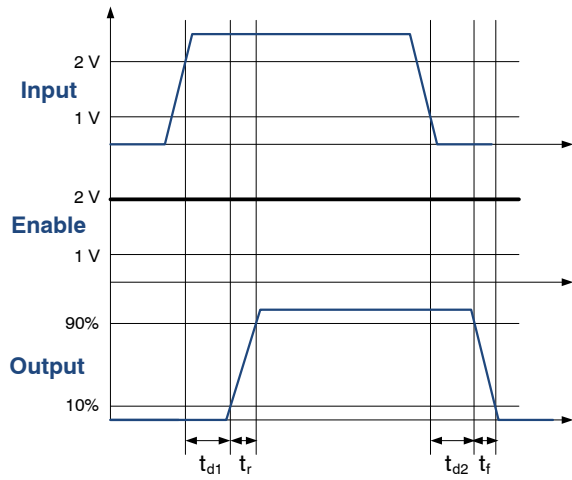

Figure 4. Non-inverting Input Driver Operation

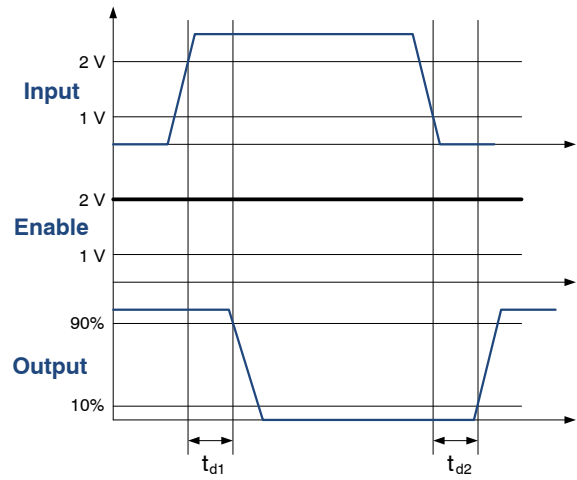

Figure 5. Inverting Input Driver Operation

TYPICAL CHARACTERISTICS

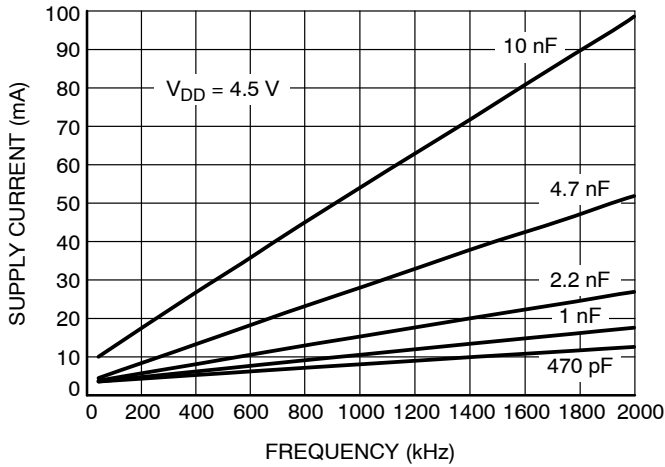

Figure 6. Supply Current vs. Switching Frequency ( $V_{DD} = 4.5\text{ V}$ )

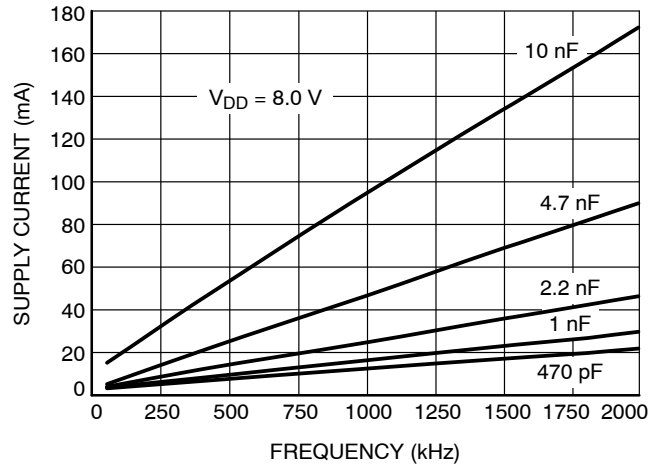

Figure 7. Supply Current vs. Switching Frequency ( $V_{DD} = 8.0\text{ V}$ )

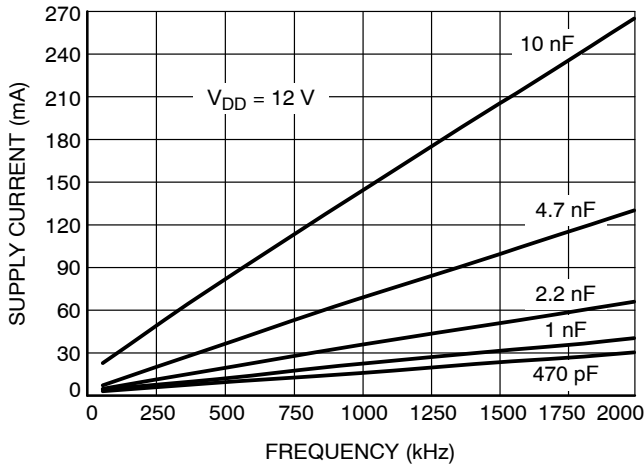

Figure 8. Supply Current vs. Switching Frequency ( $V_{DD} = 12\text{ V}$ )

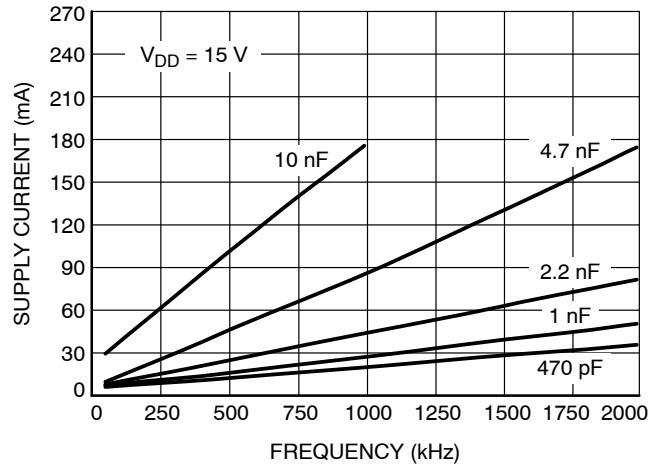

Figure 9. Supply Current vs. Switching Frequency ( $V_{DD} = 15\text{ V}$ )

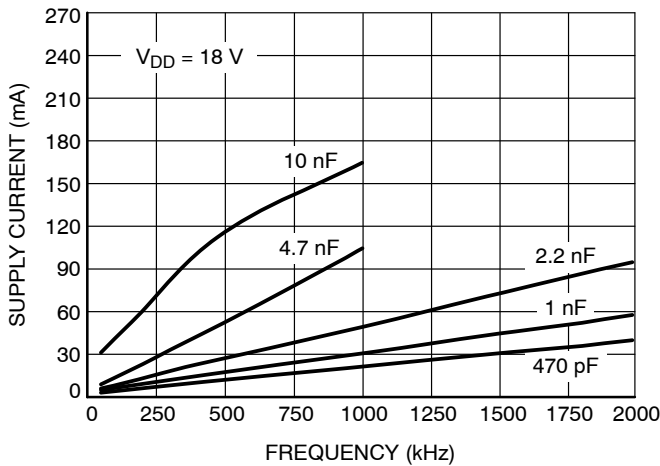

Figure 10. Supply Current vs. Switching Frequency ( $V_{DD} = 18\text{ V}$ )

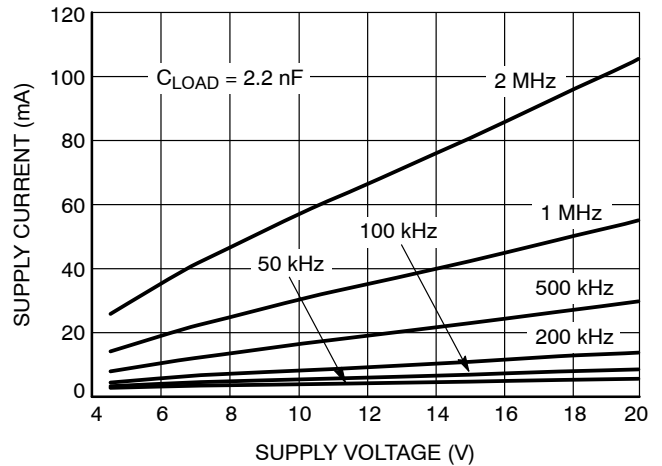

Figure 11. Supply Current vs. Supply Voltage ( $C_{LOAD} = 2.2\text{ nF}$ )

TYPICAL CHARACTERISTICS

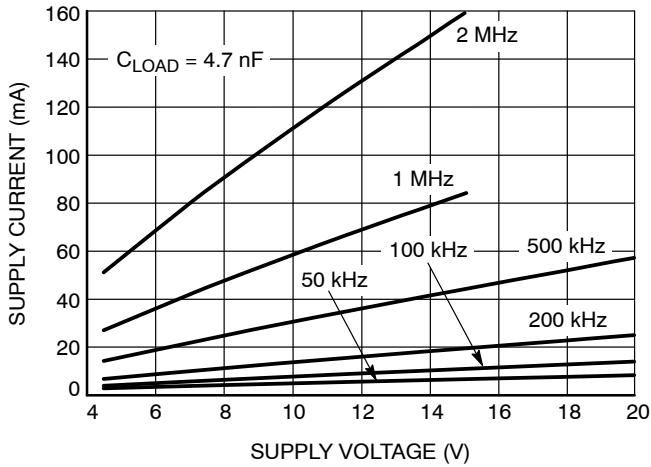

Figure 12. Supply Current vs. Supply Voltage ( $C_{LOAD} = 4.7$  nF)

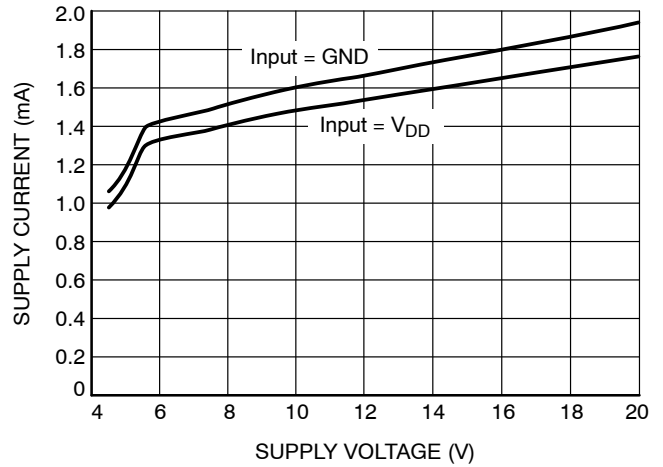

Figure 13. Supply Current vs. Supply Voltage (NCV81071A)

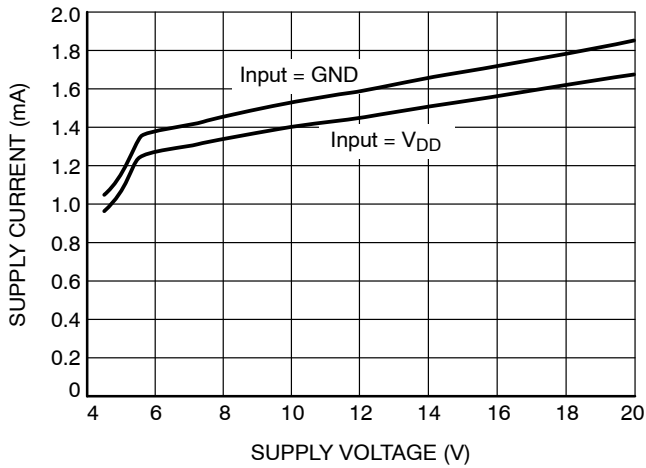

Figure 14. Supply Current vs. Supply Voltage (NCV81071B)

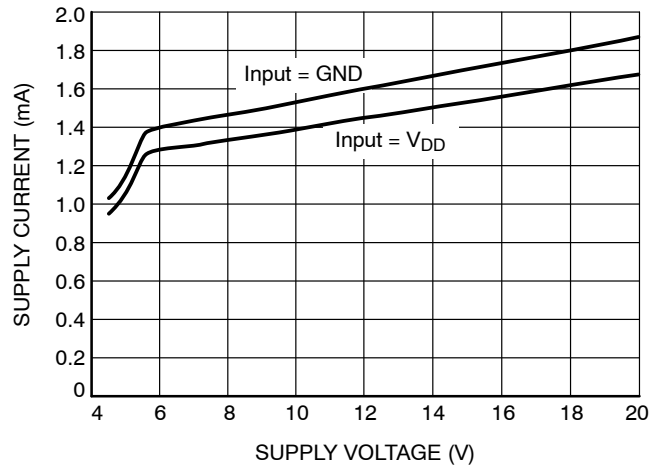

Figure 15. Supply Current vs. Supply Voltage (NCV81071C)

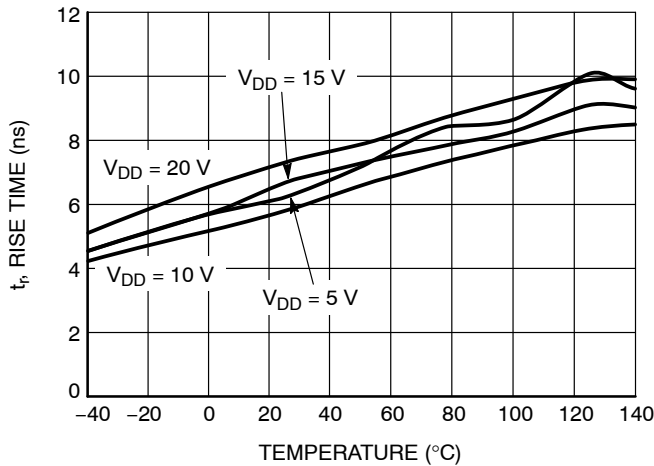

Figure 16. Rise Time vs. Temperature

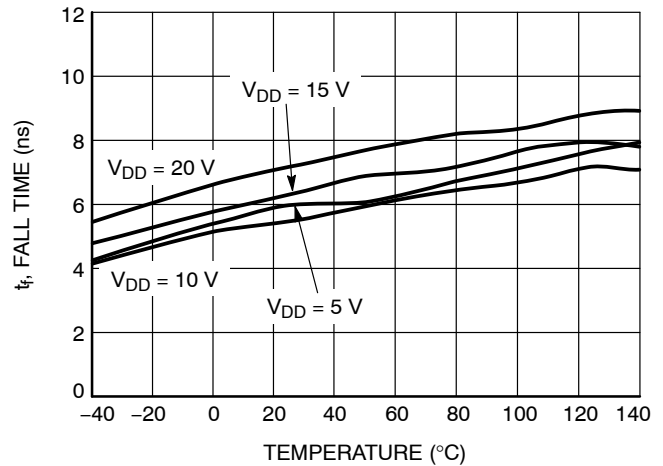

Figure 17. Fall Time vs. Temperature



TYPICAL CHARACTERISTICS

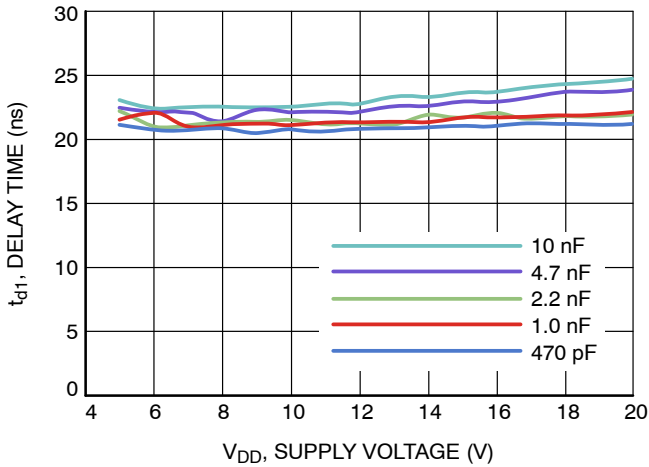

Figure 18. Propagation Delay  $t_{d1}$  vs. Supply Voltage

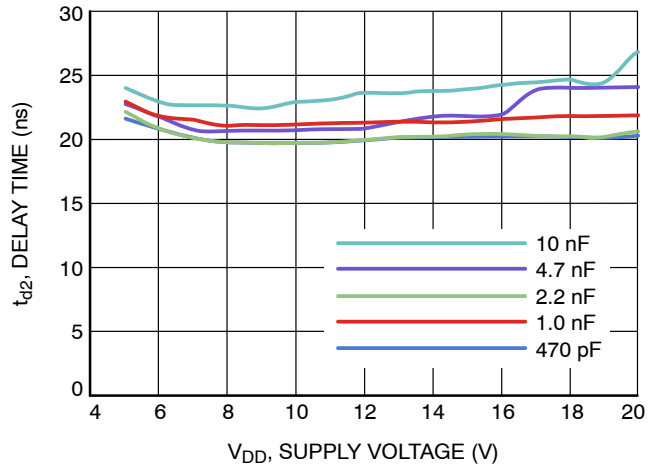

Figure 19. Propagation Delay  $t_{d2}$  vs. Supply Voltage

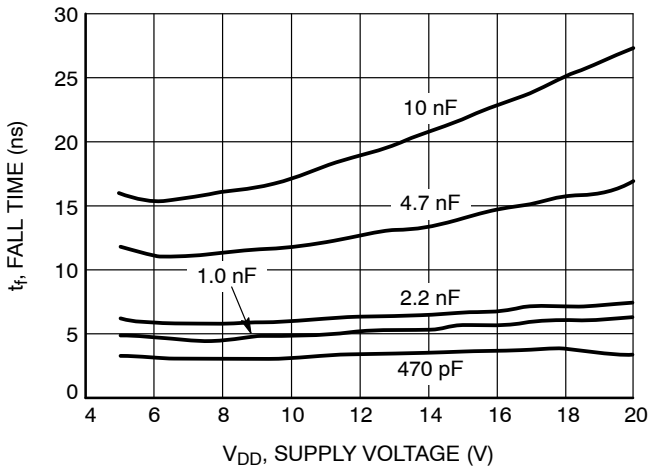

Figure 20. Fall Time  $t_f$  vs. Supply Voltage

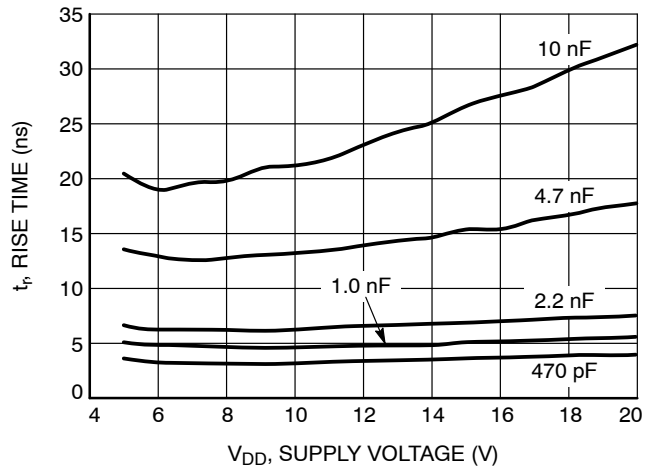

Figure 21. Rise Time  $t_r$  vs. Supply Voltage

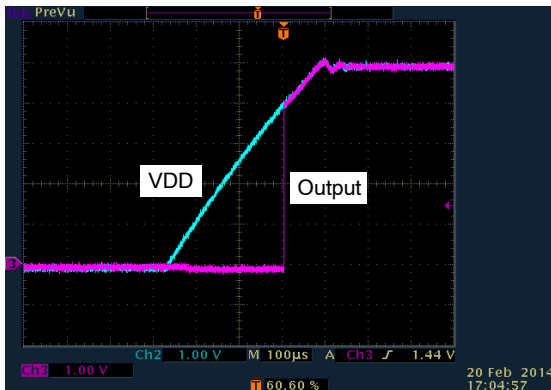

Figure 22. Output Behavior vs. Supply Voltage NCV81071A (Inverting) 10 nF between Output and GND, INA = GND, ENA = VDD

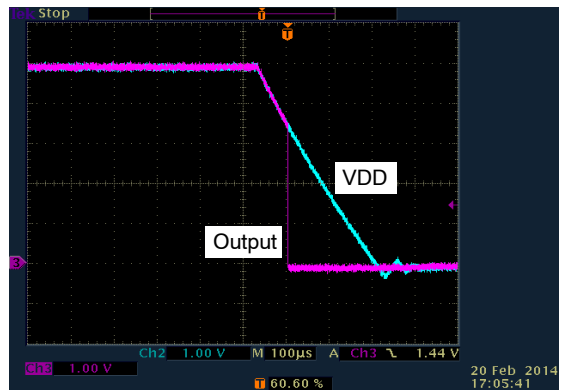

Figure 23. Output Behavior vs. Supply Voltage NCV81071A (Inverting) 10 nF between Output and GND, INA = GND, ENA = VDD

TYPICAL CHARACTERISTICS

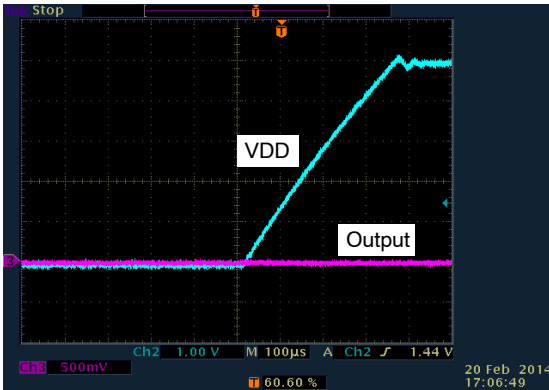

Figure 24. Output Behavior vs. Supply Voltage NCV81071A (Inverting) 10 nF between Output and GND, INA = VDD, ENA = VDD

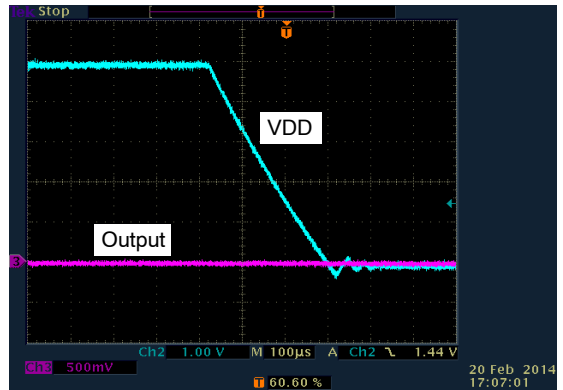

Figure 25. Output Behavior vs. Supply Voltage NCV81071A (Inverting) 10 nF between Output and GND, INA = VDD, ENA = VDD

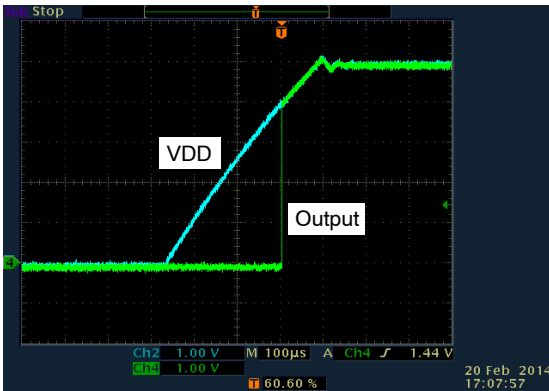

Figure 26. Output Behavior vs. Supply Voltage NCV81071B (Non-Inverting) 10 nF between Output and GND, INA = VDD, ENA = VDD

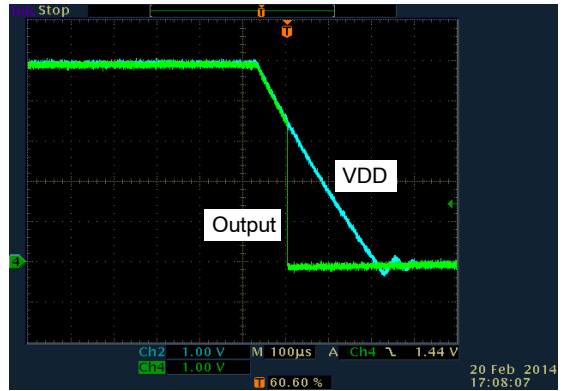

Figure 27. Output Behavior vs. Supply Voltage NCV81071B (Non-Inverting) 10 nF between Output and GND, INA = VDD, ENA = VDD

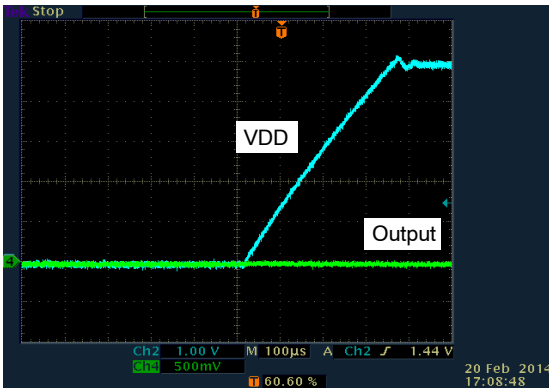

Figure 28. Output Behavior vs. Supply Voltage NCV81071B (Non-Inverting) 10 nF between Output and GND, INA = GND, ENA = VDD

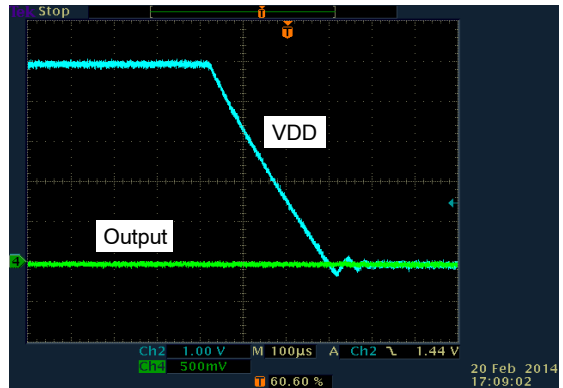

Figure 29. Output Behavior vs. Supply Voltage NCV81071B (Non-Inverting) 10 nF between Output and GND, INA = GND, ENA = VDD

# NCV81071

## LAYOUT GUIDELINES

The switching performance of NCV81071 highly depends on the design of PCB board. The following layout design guidelines are recommended when designing boards using these high speed drivers.

Place the driver as close as possible to the driven MOSFET.

Place the bypass capacitor between VDD and GND as close as possible to the driver to improve the noise filtering. It is preferred to use low inductance components such as chip capacitor and chip resistor. If vias are used, connect several paralleled vias to reduce the inductance of the vias.

Minimize the turn-on/sourcing current and turn-off/sinking current paths in order to minimize stray inductance. Otherwise high di/dt established in these loops with stray inductance can induce significant voltage spikes on the output of the driver and MOSFET Gate terminal.

Keep power loops as short as possible by paralleling the source and return traces (flux cancellation).

Keep low level signal lines away from high level power lines with a lot of switching noise.

Place a ground plane for better noise shielding. Beside noise shielding, ground plane is also useful for heat dissipation.

NCV81071 MSOP package has a thermal pad for: 1) quiet GND for all the driver circuits; 2) heat sink for the driver. This pad must be connected to a ground plane and no switching currents from the driven MOSFET should pass through the ground plane under the driver. To maximize the heatsinking capability, it is recommended several ground layers are added to connect to the ground plane and thermal pad. A via array within the area of package can conduct the heat from the package to the ground layers and the whole PCB board. The number of vias and the size of ground plane are determined by the power dissipation of NCV81071 (VDD voltage, switching frequency and load condition), the air flow condition and its maximum junction temperature.

## ORDERING INFORMATION

| Part Number   | Marking | Output Configuration               | Temperature Range | Package Type          | Shipping†          |
|---------------|---------|------------------------------------|-------------------|-----------------------|--------------------|
| NCV81071AZR2G | V71A    | dual inverting                     | -40°C to +140°C   | MSOP8 EP<br>(Pb-Free) | 3000 / Tape & Reel |
| NCV81071BZR2G | V71B    | dual non inverting                 |                   |                       |                    |
| NCV81071CZR2G | V71C    | One inverting<br>one non inverting |                   |                       |                    |

†For information on tape and reel specifications, including part orientation and tape sizes, please refer to our Tape and Reel Packaging Specifications Brochure, BRD8011/D.

# MECHANICAL CASE OUTLINE PACKAGE DIMENSIONS

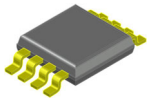

## MSOP8 EP, 3x3 CASE 846AM ISSUE B

DATE 07 JAN 2022

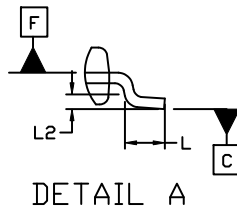
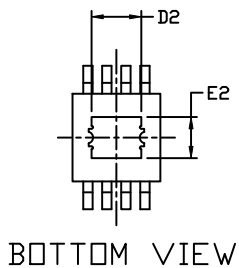
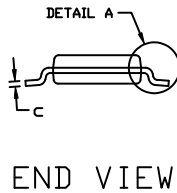
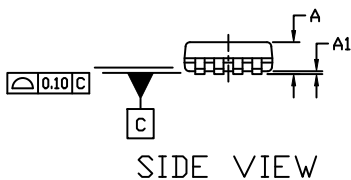
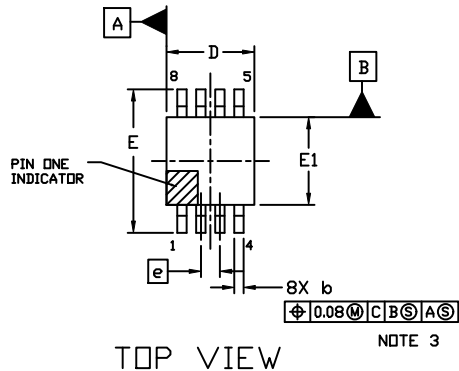

### NOTES:

- DIMENSIONING AND TOLERANCING PER ASME Y14.5M, 1994.
- CONTROLLING DIMENSION: MILLIMETERS
- DIMENSION *b* DOES NOT INCLUDE DAMBAR PROTRUSION. ALLOWABLE PROTRUSION SHALL BE 0.10 mm IN EXCESS OF MAXIMUM MATERIAL CONDITION.
- DIMENSION *D* DOES NOT INCLUDE MOLD FLASH, PROTRUSIONS, OR GATE BURRS. MOLD FLASH, PROTRUSIONS, OR GATE BURRS SHALL NOT EXCEED 0.15 mm PER SIDE. DIMENSION *E* DOES NOT INCLUDE INTERLEAD FLASH OR PROTRUSION. INTERLEAD FLASH OR PROTRUSION SHALL NOT EXCEED 0.25 mm PER SIDE. DIMENSIONS *D* AND *E* ARE DETERMINED AT DATUM *F*.
- DATUMS *A* AND *B* ARE TO BE DETERMINED AT DATUM *F*.
- A1* IS DEFINED AS THE VERTICAL DISTANCE FROM THE SEATING PLANE TO THE LOWEST POINT ON THE PACKAGE BODY.

| DIM       | MILLIMETERS |      |
|-----------|-------------|------|
|           | MIN.        | MAX. |
| A         | ---         | 1.10 |
| A1        | 0.05        | 0.15 |
| <i>b</i>  | 0.25        | 0.40 |
| <i>c</i>  | 0.13        | 0.23 |
| <i>D</i>  | 2.90        | 3.10 |
| <i>D2</i> | 1.73        | 1.83 |
| <i>E</i>  | 4.75        | 5.05 |
| <i>E1</i> | 2.90        | 3.10 |
| <i>E2</i> | 1.37        | 1.47 |
| <i>e</i>  | 0.65 BSC    |      |
| <i>L</i>  | 0.40        | 0.70 |
| <i>L2</i> | 0.254 BSC   |      |

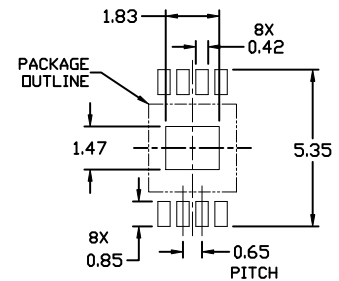

\* FOR ADDITIONAL INFORMATION ON OUR Pb-FREE STRATEGY AND SOLDERING DETAILS, PLEASE DOWNLOAD THE ONSEMI SOLDERING AND MOUNTING TECHNIQUES REFERENCE MANUAL, SOLDERM/D.

### GENERIC MARKING DIAGRAM\*

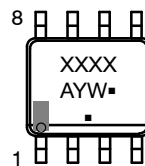

- XXXX = Specific Device Code
- A = Assembly Location
- Y = Year
- W = Work Week
- = Pb-Free Package

(Note: Microdot may be in either location)  
\*This information is generic. Please refer to device data sheet for actual part marking. Pb-Free indicator, "G" or microdot "▪", may or may not be present. Some products may not follow the Generic Marking.

|                  |               |  |
|------------------|---------------|--|
| DOCUMENT NUMBER: | 98AON82708F   | Electronic versions are uncontrolled except when accessed directly from the Document Repository. Printed versions are uncontrolled except when stamped "CONTROLLED COPY" in red. |
| DESCRIPTION:     | MSOP8 EP, 3X3 | PAGE 1 OF 1  |

onsemi and onsemi are trademarks of Semiconductor Components Industries, LLC dba onsemi or its subsidiaries in the United States and/or other countries. onsemi reserves the right to make changes without further notice to any products herein. onsemi makes no warranty, representation or guarantee regarding the suitability of its products for any particular purpose, nor does onsemi assume any liability arising out of the application or use of any product or circuit, and specifically disclaims any and all liability, including without limitation special, consequential or incidental damages. onsemi does not convey any license under its patent rights nor the rights of others.

**onsemi**, **Onsemi**, and other names, marks, and brands are registered and/or common law trademarks of Semiconductor Components Industries, LLC dba "**onsemi**" or its affiliates and/or subsidiaries in the United States and/or other countries. **onsemi** owns the rights to a number of patents, trademarks, copyrights, trade secrets, and other intellectual property. A listing of **onsemi**'s product/patent coverage may be accessed at [www.onsemi.com/site/pdf/Patent-Marking.pdf](http://www.onsemi.com/site/pdf/Patent-Marking.pdf). **onsemi** reserves the right to make changes at any time to any products or information herein, without notice. The information herein is provided "as-is" and **onsemi** makes no warranty, representation or guarantee regarding the accuracy of the information, product features, availability, functionality, or suitability of its products for any particular purpose, nor does **onsemi** assume any liability arising out of the application or use of any product or circuit, and specifically disclaims any and all liability, including without limitation special, consequential or incidental damages. Buyer is responsible for its products and applications using **onsemi** products, including compliance with all laws, regulations and safety requirements or standards, regardless of any support or applications information provided by **onsemi**. "Typical" parameters which may be provided in **onsemi** data sheets and/or specifications can and do vary in different applications and actual performance may vary over time. All operating parameters, including "Typicals" must be validated for each customer application by customer's technical experts. **onsemi** does not convey any license under any of its intellectual property rights nor the rights of others. **onsemi** products are not designed, intended, or authorized for use as a critical component in life support systems or any FDA Class 3 medical devices or medical devices with a same or similar classification in a foreign jurisdiction or any devices intended for implantation in the human body. Should Buyer purchase or use **onsemi** products for any such unintended or unauthorized application, Buyer shall indemnify and hold **onsemi** and its officers, employees, subsidiaries, affiliates, and distributors harmless against all claims, costs, damages, and expenses, and reasonable attorney fees arising out of, directly or indirectly, any claim of personal injury or death associated with such unintended or unauthorized use, even if such claim alleges that **onsemi** was negligent regarding the design or manufacture of the part. **onsemi** is an Equal Opportunity/Affirmative Action Employer. This literature is subject to all applicable copyright laws and is not for resale in any manner.

## PUBLICATION ORDERING INFORMATION

### LITERATURE FULFILLMENT:

Email Requests to: [orderlit@onsemi.com](mailto:orderlit@onsemi.com)

**onsemi Website:** [www.onsemi.com](http://www.onsemi.com)

### TECHNICAL SUPPORT

**North American Technical Support:**

Voice Mail: 1 800-282-9855 Toll Free USA/Canada

Phone: 011 421 33 790 2910

**Europe, Middle East and Africa Technical Support:**

Phone: 00421 33 790 2910

For additional information, please contact your local Sales Representative