

Voltage Regulator - Low Dropout

400 mA

NCV4274C

Description

The NCV4274C is a precision micro-power voltage regulator with an output current capability of 400 mA available in the DPAK, D2PAK and SOT-223 packages.

The output voltage is accurate within $\pm 2.0\%$ with a maximum dropout voltage of 0.5 V with an input up to 40 V. Low quiescent current is a feature drawing only 125 μA with a 1 mA load. This part is ideal for automotive and all battery operated microprocessor equipment.

The regulator is protected against reverse battery, short circuit, and thermal overload conditions. The device can withstand load dump transients making it suitable for use in automotive environments.

Features

- 3.3 V, 5.0 V, $\pm 2.0\%$ Output Options
- Low 125 μA Quiescent Current at 1 mA load current
- 400 mA Output Current Capability
- Fault Protection
- +60 V Peak Transient Voltage with Respect to GND
 - -42 V Reverse Voltage
 - Short Circuit
 - Thermal Overload
- Very Low Dropout Voltage
- NCV Prefix for Automotive and Other Applications Requiring Unique Site and Control Change Requirements; AEC-Q100 Qualified and PPAP Capable
- These are Pb-Free Devices

MARKING DIAGRAMS



DPAK
DT SUFFIX
CASE 369C

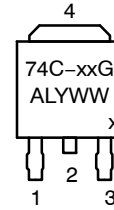

1 Input
2, 4 Ground
3 Output

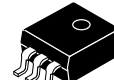

D2PAK
DS SUFFIX
CASE 418AF

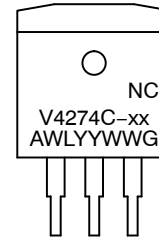

1 Input
2, 4 Ground
3 Output



SOT-223
ST SUFFIX
CASE 318E

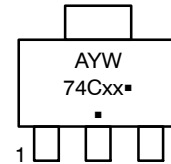

xx = 33 (3.3 V)
= 50 (5.0 V)
A = Assembly Location
L, WL = Wafer Lot
Y, YY = Year
W, WW = Work Week
G or ■ = Pb-Free Package

(Note: Microdot may be in either location)

ORDERING INFORMATION

See detailed ordering and shipping information on page 12 of this data sheet.

NOTE: Some of the devices on this data sheet have been **DISCONTINUED**. Please refer to the table on page 12.

NCV4274C

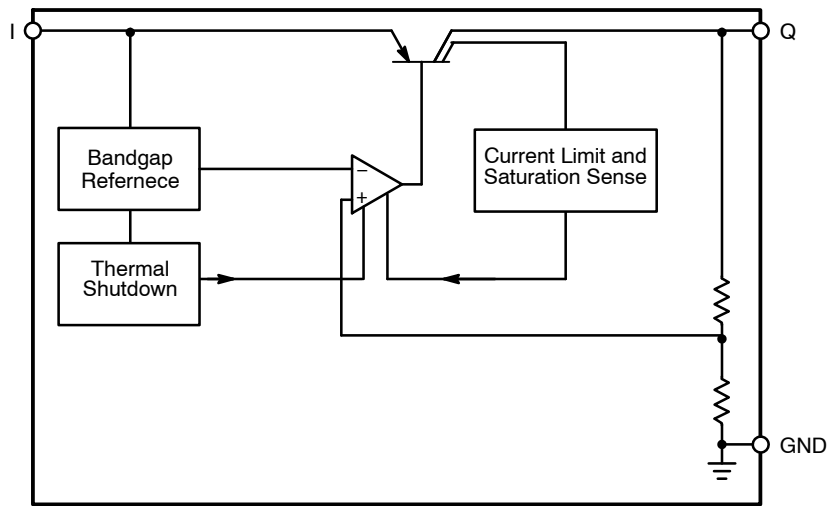

Figure 1. Block Diagram

Pin Definitions and Functions

Pin No.	Symbol	Function
1	I	Input; Bypass directly at the IC with a ceramic capacitor to GND.
2,4	GND	Ground
3	Q	Output; Bypass with a capacitor to GND.

ABSOLUTE MAXIMUM RATINGS

Pin Symbol, Parameter	Symbol	Condition	Min	Max	Unit
I, Input-to-Regulator	Voltage	V_I	-42	45	V
	Current	I_I	Internally Limited	Internally Limited	
I, Input peak Transient Voltage to Regulator with Respect to GND (Note 1)	V_I			60	V
Q, Regulated Output	Voltage	$V_Q = V_I$	-1.0	40	V
	Current	I_Q	Internally Limited	Internally Limited	
GND, Ground Current	I_{GND}		-	100	mA
Junction Temperature	T_J		-40	150	°C
Storage Temperature	T_{Stg}		-50	150	°C
ESD Capability, Human Body Model (Note 2)	ESD_{HB}		4		kV
ESD Capability, Machine Model (Note 2)	ESD_{MM}		200		V
ESD Capability, Charged Device Model (Note 2)	ESD_{CDM}		1		kV

Stresses exceeding those listed in the Maximum Ratings table may damage the device. If any of these limits are exceeded, device functionality should not be assumed, damage may occur and reliability may be affected.

- Load Dump Test B (with centralized load dump suppression) according to ISO16750-2 standard. Guaranteed by design. Not tested in production. Passed Class C.
- This device series incorporates ESD protection and is tested by the following methods:
 ESD HBM tested per AEC-Q100-002 (EIA/JESD22-A114)
 ESD MM tested per AEC-Q100-003 (EIA/JESD22-A115)
 Field Induced Charge Device Model ESD characterization is not performed on plastic molded packages with body sizes $<50\text{mm}^2$ due to the inability of a small package body to acquire and retain enough charge to meet the minimum CDM discharge current waveform characteristic defined in JEDEC JS-002-2014.

NCV4274C

OPERATING RANGE

Parameter	Symbol	Condition	Min	Max	Unit
Input Voltage (5.0 V Version)	V_I		5.5	40	V
Input Voltage (3.3 V Version)	V_I		4.5	40	V
Junction Temperature	T_J		-40	150	°C

Functional operation above the stresses listed in the Recommended Operating Ranges is not implied. Extended exposure to stresses beyond the Recommended Operating Ranges limits may affect device reliability.

THERMAL RESISTANCE

Parameter	Symbol	Condition	Min	Max	Unit
Junction-to-Ambient	DPAK R_{thja}		-	72.5 (Note 3)	°C/W
Junction-to-Ambient	D2PAK R_{thja}		-	56.7 (Note 3)	°C/W
Junction-to-Case	DPAK R_{thjc}		-	5.8	°C/W
Junction-to-Case	D2PAK R_{thjc}		-	5.8	°C/W
Junction-to-Tab	SOT-223 Ψ_{-JLX} , Ψ_{LX}		-	15.6 (Note 3)	°C/W
Junction-to-Ambient	SOT-223 $R_{\theta JA}$, θ_{JA}		-	87 (Note 3)	°C/W

3. 1 oz copper, 300 mm² copper area, single-sided FR4 PCB.

MOISTURE SENSITIVITY LEVEL (Note 4)

Parameter	Symbol	Condition	Min	Max	Unit
Moisture Sensitivity Level	MSL	DPAK and D2PAK SOT-223	1 3	- -	

4. For more information, please refer to our Soldering and Mounting Techniques Reference Manual, SOLDERRM/D.

NCV4274C

ELECTRICAL CHARACTERISTICS

-40°C < T_J < 150°C; V_I = 13.5 V unless otherwise noted.

Parameter	Symbol	Test Conditions	Min	Typ	Max	Unit
REGULATOR						
Output Voltage (5.0 V Version)	V _Q	5 mA < I _Q < 400 mA 6 V < V _I < 28 V	4.9	5.0	5.1	V
Output Voltage (5.0 V Version)	V _Q	5 mA < I _Q < 200 mA 6 V < V _I < 40 V	4.9	5.0	5.1	V
Output Voltage (3.3 V Version)	V _Q	5 mA < I _Q < 400 mA 4.5 V < V _I < 28 V	3.23	3.3	3.37	V
Output Voltage (3.3 V Version)	V _Q	5 mA < I _Q < 200 mA 4.5 V < V _I < 40 V	3.23	3.3	3.37	V
Current Limit (All Versions)	I _Q	V _Q = 90% V _Q TYP	400	600	-	mA
Quiescent Current	I _q	I _Q = 1 mA V _Q = 5.0 V V _Q = 3.3 V I _Q = 250 mA V _Q = 5.0 V V _Q = 3.3 V I _Q = 400 mA V _Q = 5.0 V V _Q = 3.3 V	-	125	250	μA μA mA mA mA mA
Dropout Voltage 5.0 V Version	V _{DR}	I _Q = 250 mA, V _{DR} = V _I - V _Q V _I = 5.0 V	-	250	500	mV
Load Regulation (3.3 V and 5 V Versions)	ΔV _Q	I _Q = 5 mA to 400 mA	-	3	20	mV
Line Regulation (3.3 V and 5 V Versions)	ΔV _Q	ΔV _I = 12 V to 32 V I _Q = 5 mA	-	4	25	mV
Power Supply Ripple Rejection	PSRR	f _r = 100 Hz, V _r = 0.5 V _{PP}	-	60	-	dB
Thermal Shutdown Temperature*	T _{SD}	I _Q = 5 mA	150	-	210	°C

Product parametric performance is indicated in the Electrical Characteristics for the listed test conditions, unless otherwise noted. Product performance may not be indicated by the Electrical Characteristics if operated under different conditions.

*Guaranteed by design, not tested in production

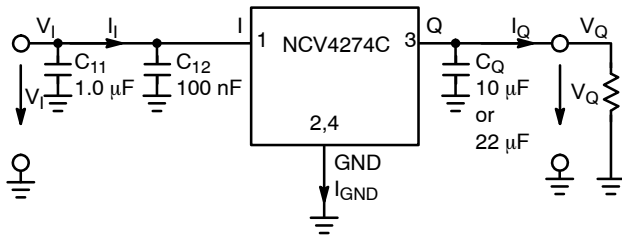

Figure 2. Measuring Circuit

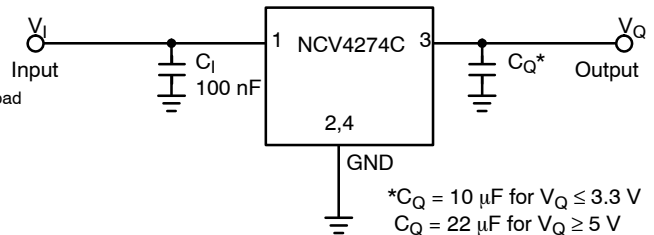

Figure 3. Application Circuit

TYPICAL CHARACTERISTIC CURVES – 5 V VERSION

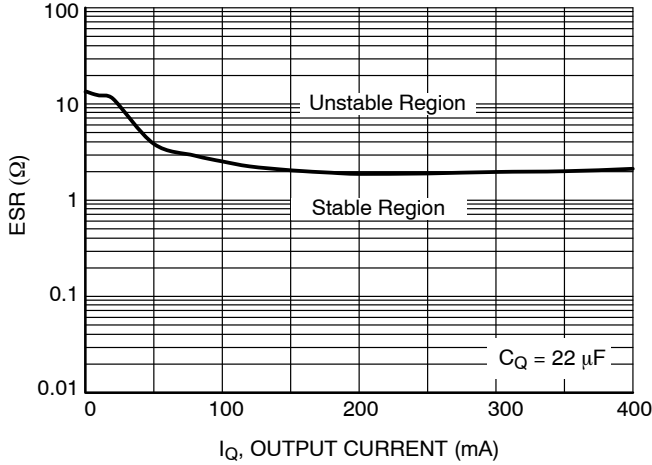

Figure 4. Output Stability with Output Capacitor ESR

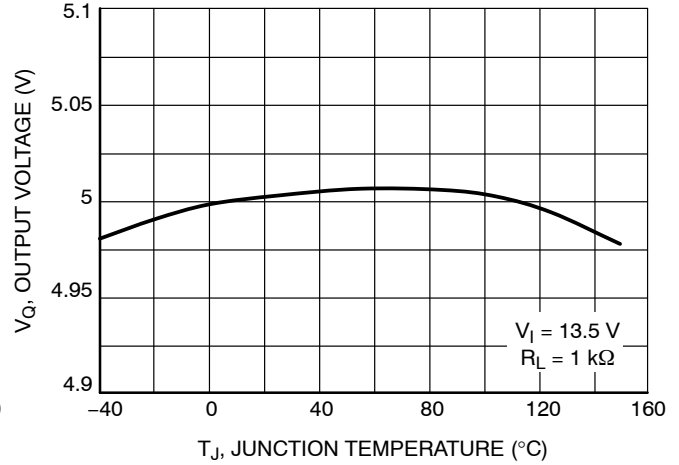

Figure 5. Output Voltage vs. Junction Temperature

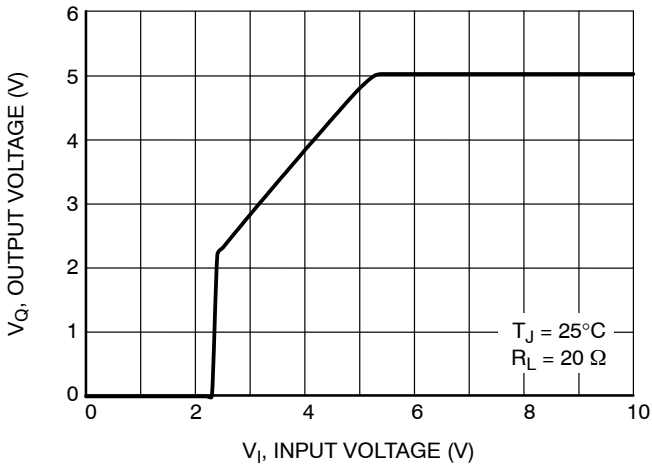

Figure 6. Output Voltage vs. Input Voltage

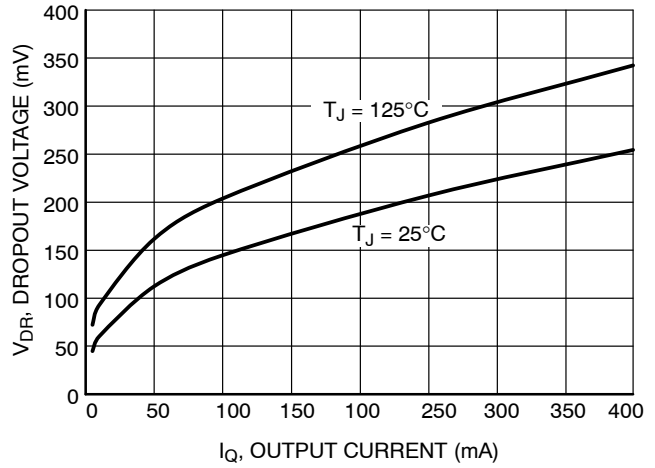

Figure 7. Dropout Voltage vs. Output Current

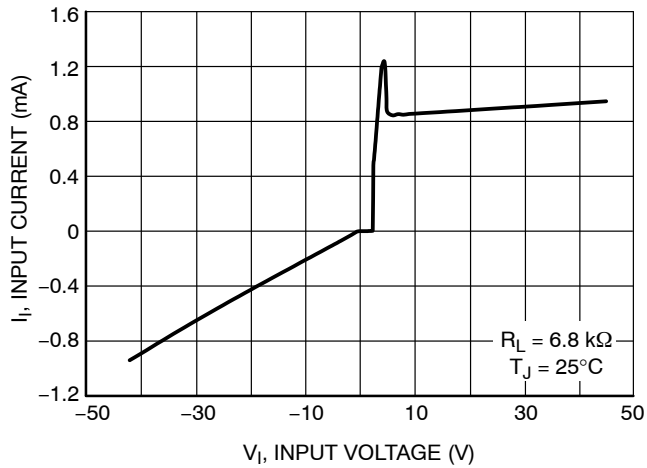

Figure 8. Input Current vs. Input Voltage

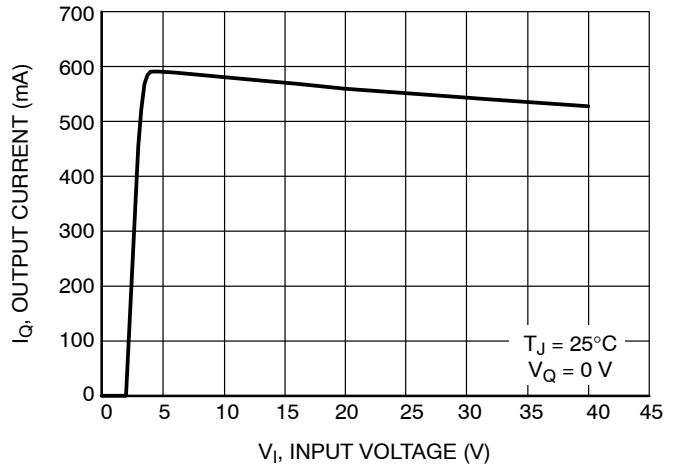

Figure 9. Maximum Output Current vs. Input Voltage

TYPICAL CHARACTERISTIC CURVES – 5 V VERSION

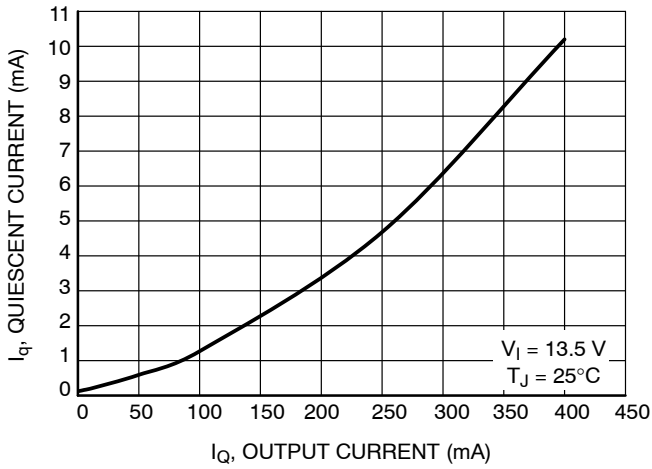

Figure 10. Quiescent Current vs. Output Current (High Load)

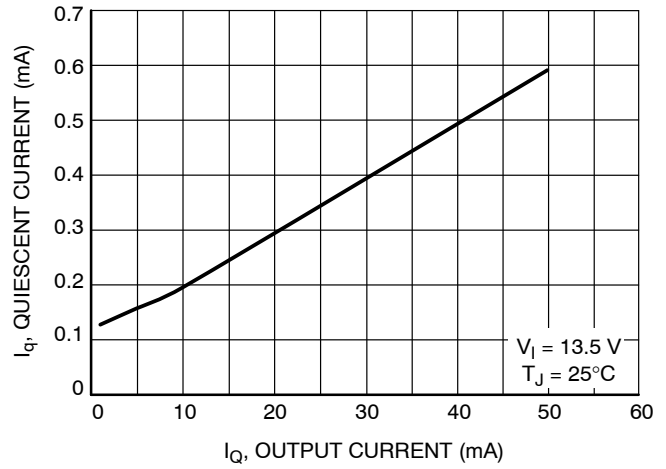

Figure 11. Quiescent Current vs. Output Current (Low Load)

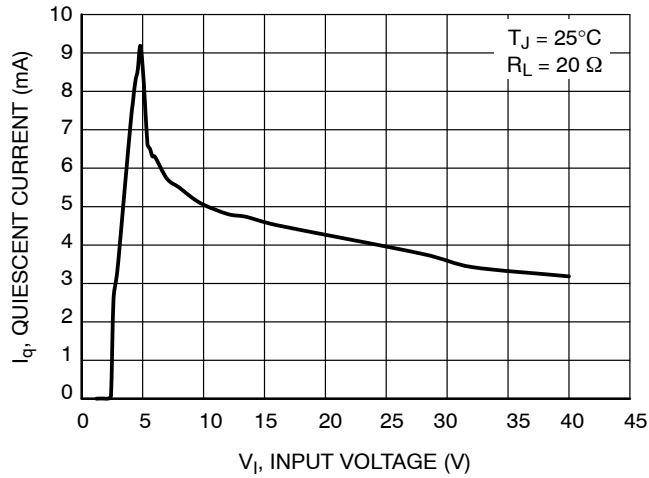

Figure 12. Quiescent Current vs. Input Voltage

TYPICAL CHARACTERISTIC CURVES – 3.3 V VERSION

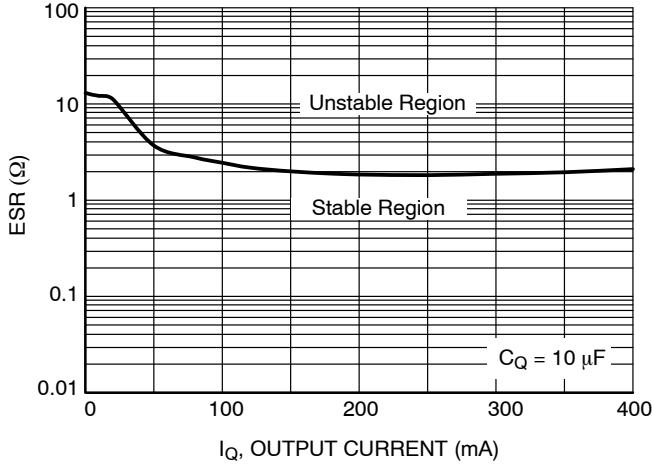

Figure 13. Output Stability with Output Capacitor ESR

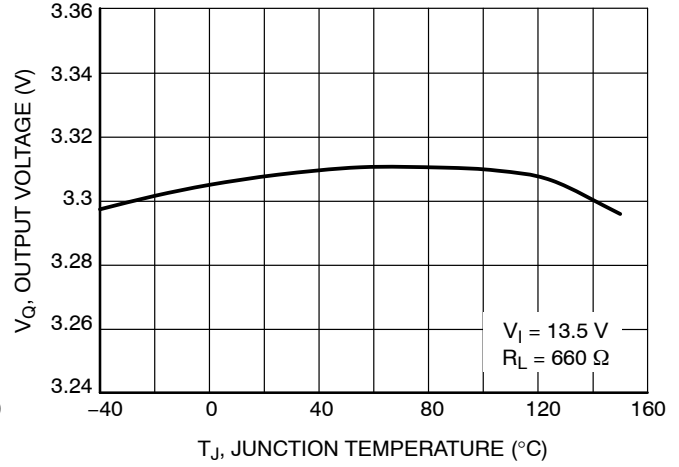

Figure 14. Output Voltage vs. Junction Temperature

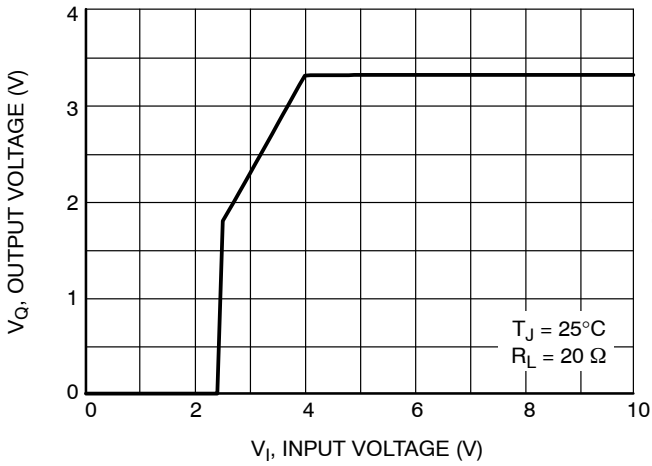

Figure 15. Output Voltage vs. Input Voltage

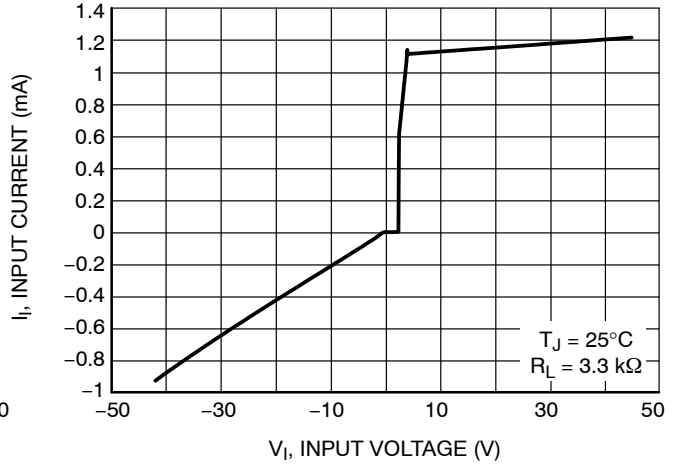

Figure 16. Input Current vs. Input Voltage

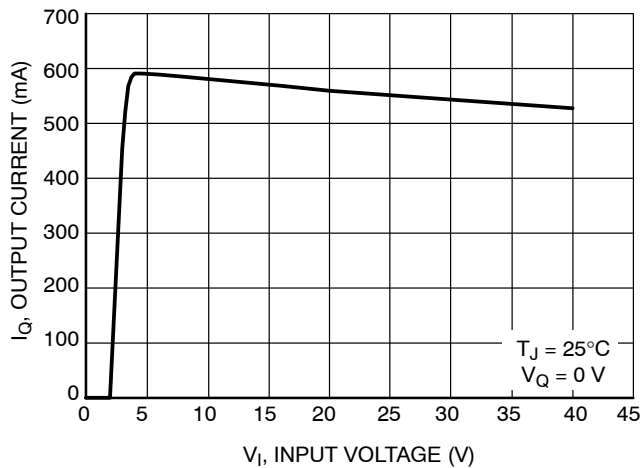

Figure 17. Maximum Output Current vs. Input Voltage

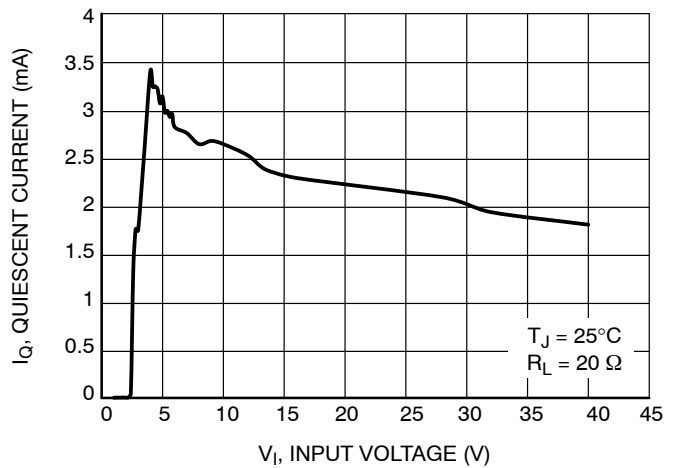

Figure 18. Quiescent Current vs. Input Voltage

TYPICAL CHARACTERISTIC CURVES – 3.3 V VERSION

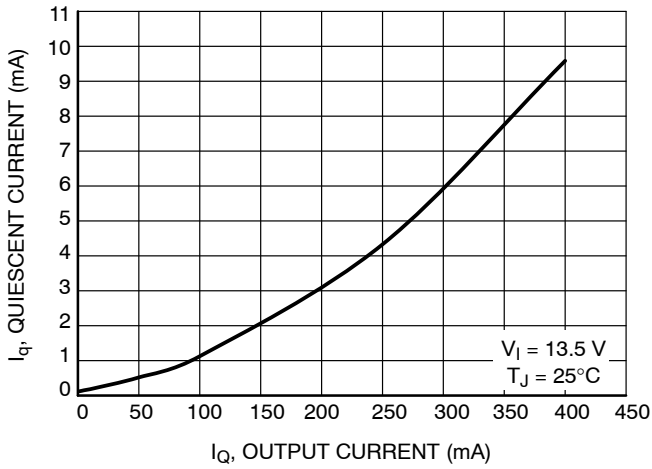

Figure 19. Quiescent Current vs. Output Current (High Load)

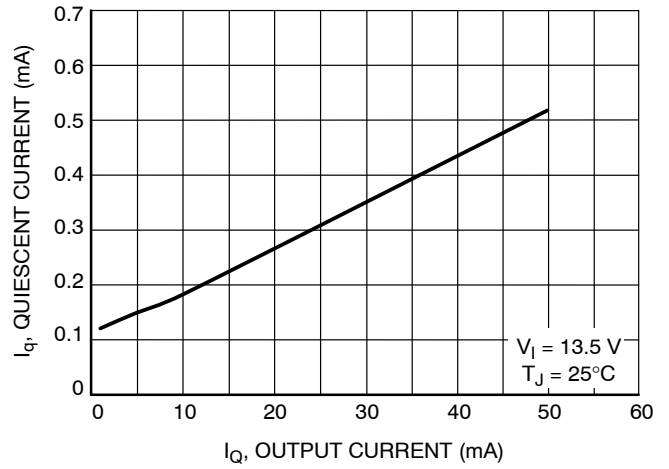

Figure 20. Quiescent Current vs. Output Current (Low Load)

APPLICATION DESCRIPTION

Output Regulator

The output is controlled by a precision trimmed reference and error amplifier. The PNP output has saturation control for regulation while the input voltage is low, preventing over saturation. Current limit and voltage monitors complement the regulator design to give safe operating signals to the processor and control circuits.

Stability Considerations

The input capacitor C_{I1} in Figure 2 is necessary for compensating input line reactance. Possible oscillations caused by input inductance and input capacitance can be damped by using a resistor of approximately 1 Ω in series with C_{I2}.

The output or compensation capacitor helps determine three main characteristics of a linear regulator: startup delay, load transient response and loop stability.

The capacitor value and type should be based on cost, availability, size and temperature constraints. The aluminum electrolytic capacitor is the least expensive solution, but, if the circuit operates at low temperatures (–25°C to –40°C), both the value and ESR of the capacitor will vary considerably. The capacitor manufacturer’s data sheet usually provides this information.

The value for the output capacitor C_O shown in Figure 2 should work for most applications; however, it is not necessarily the optimized solution. Actual Stability Regions are shown in a graphs in the Typical Performance Characteristics section.

Calculating Power Dissipation in a Single Output Linear Regulator

The maximum power dissipation for a single output regulator (Figure 3) is:

$$P_{D(max)} = [V_{I(max)} - V_{Q(min)}]I_{Q(max)} + V_{I(max)}I_q \quad (\text{eq. 1})$$

Where:

- V_{I(max)} is the maximum input voltage,
- V_{Q(min)} is the minimum output voltage,
- I_{Q(max)} is the maximum output current for the application, and
- I_q is the quiescent current the regulator consumes at I_{Q(max)}.

Once the value of P_{D(max)} is known, the maximum permissible value of R_{θJA} can be calculated:

$$R_{\theta JA} = \frac{(150\text{ C} - T_A)}{P_D} \quad (\text{eq. 2})$$

The value of R_{θJA} can then be compared with those in the package section of the data sheet. Those packages with R_{θJA}’s less than the calculated value in Equation 2 will keep the die temperature below 150°C. In some cases, none of the packages will be sufficient to dissipate the heat generated by the IC, and an external heat sink will be required. The current flow and voltages are shown in the Measurement Circuit Diagram.

Heat Sinks

A heat sink effectively increases the surface area of the package to improve the flow of heat away from the IC and into the surrounding air.

Each material in the heat flow path between the IC and the outside environment will have a thermal resistance. Like series electrical resistances, these resistances are summed to determine the value of R_{θJA}:

$$R_{\theta JA} = R_{\theta JC} + R_{\theta CS} + R_{\theta SA} \quad (\text{eq. 3})$$

Where:

- R_{θJC} = the junction–to–case thermal resistance,
- R_{θCS} = the case–to–heat sink thermal resistance, and
- R_{θSA} = the heat sink–to–ambient thermal resistance.

R_{θJC} appears in the package section of the data sheet. Like R_{θJA}, it too is a function of package type. R_{θCS} and R_{θSA} are functions of the package type, heat sink and the interface between them. These values appear in data sheets of heat sink manufacturers.

Thermal, mounting, and heat sinking are discussed in the **onsemi** application note AN1040/D, available on the [onsemi Website](http://www.onsemi.com).

NCV4274C

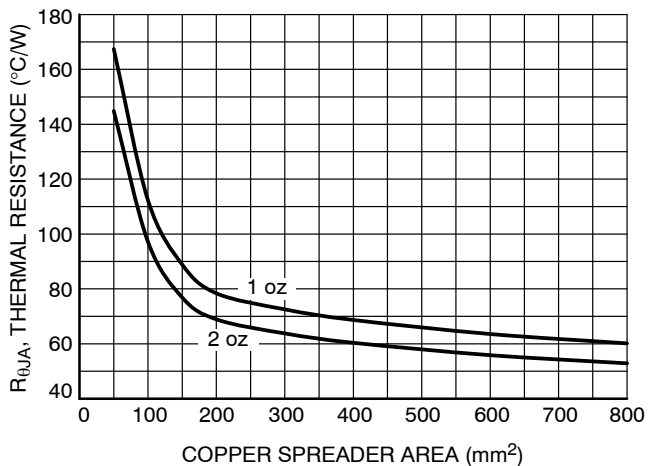

Figure 21. $R_{\theta JA}$ vs. Copper Spreader Area, DPAK 3-Lead

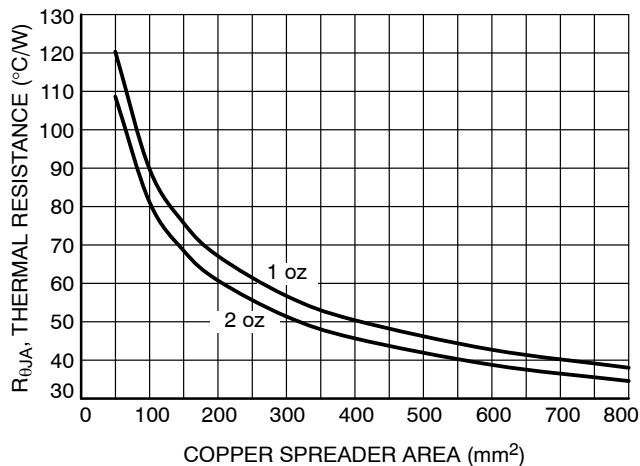

Figure 22. $R_{\theta JA}$ vs. Copper Spreader Area, D²PAK 3-Lead

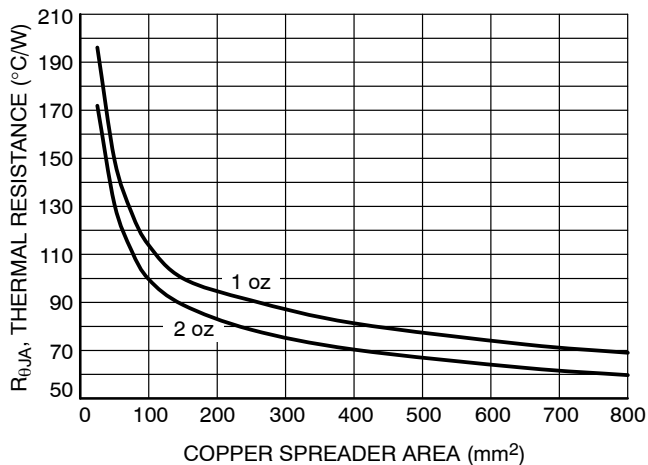

Figure 23. $R_{\theta JA}$ vs. Copper Spreader Area, SOT 223-Lead

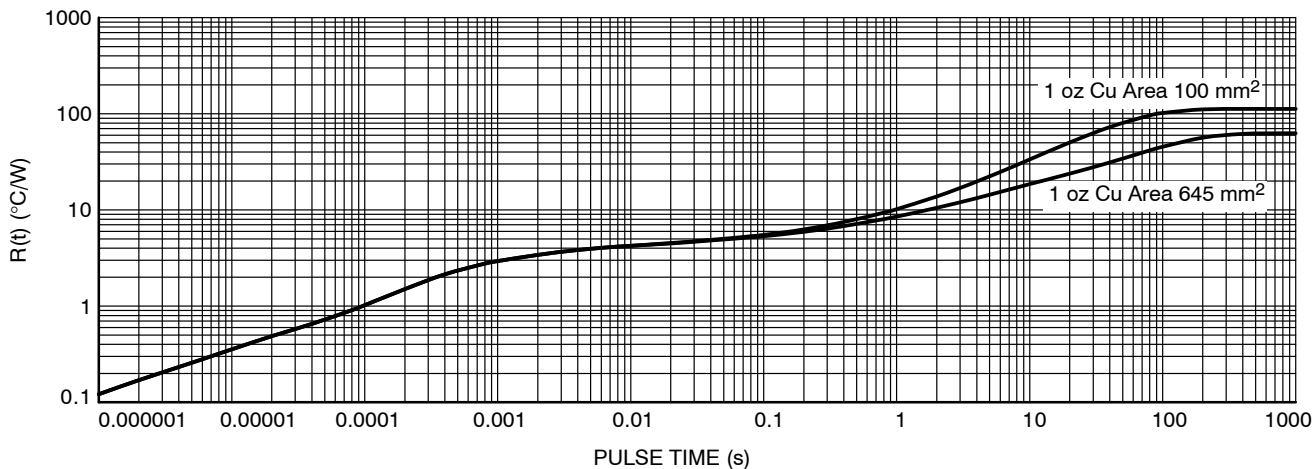

Figure 24. Single-Pulse Heating Curves, DPAK 3-Lead

NCV4274C

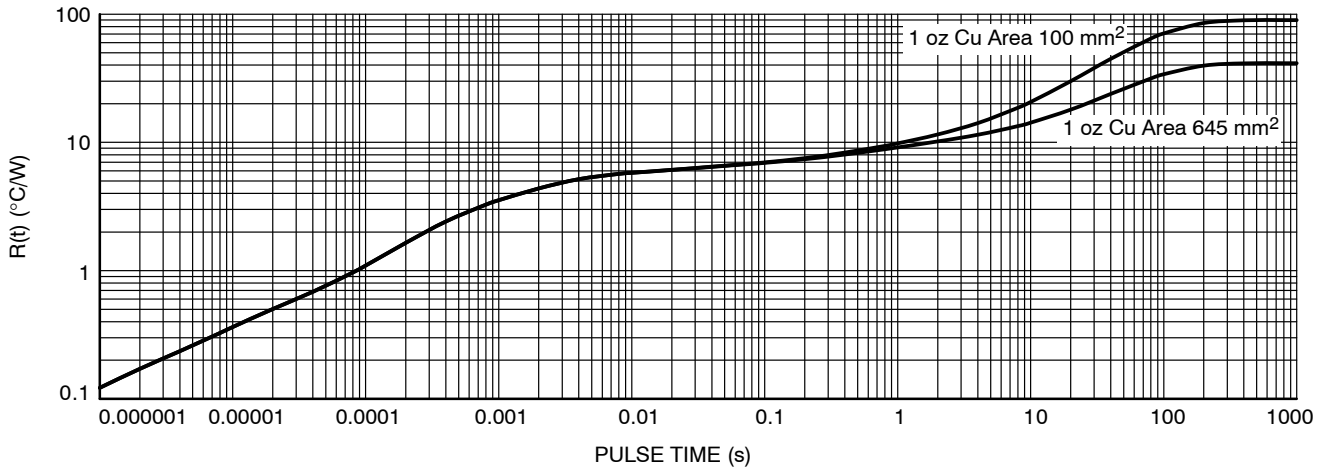

Figure 25. Single-Pulse Heating Curves, D²PAK 3-Lead

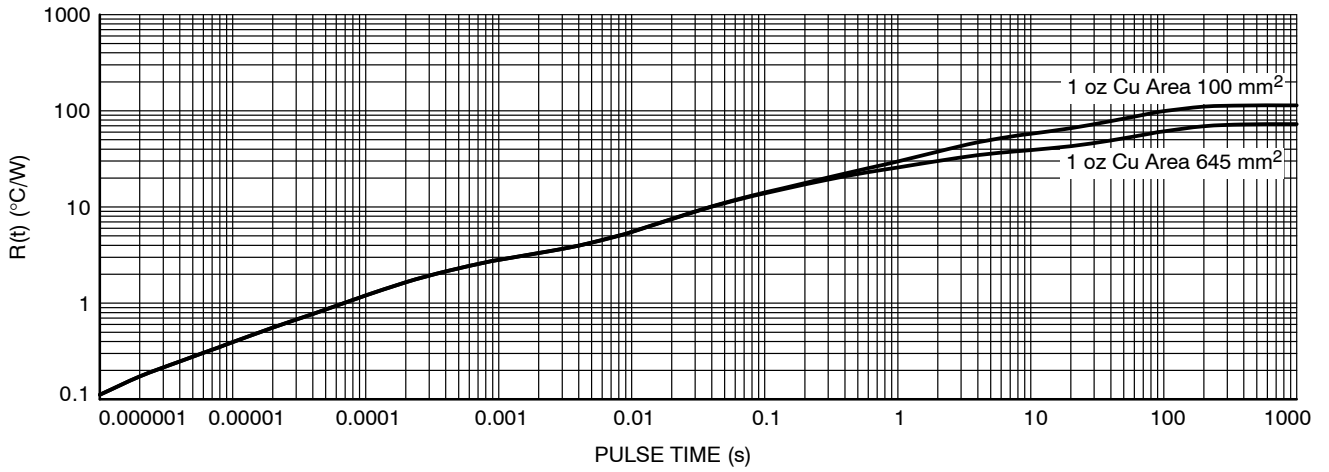

Figure 26. Single-Pulse Heating Curves, SOT 223-Lead

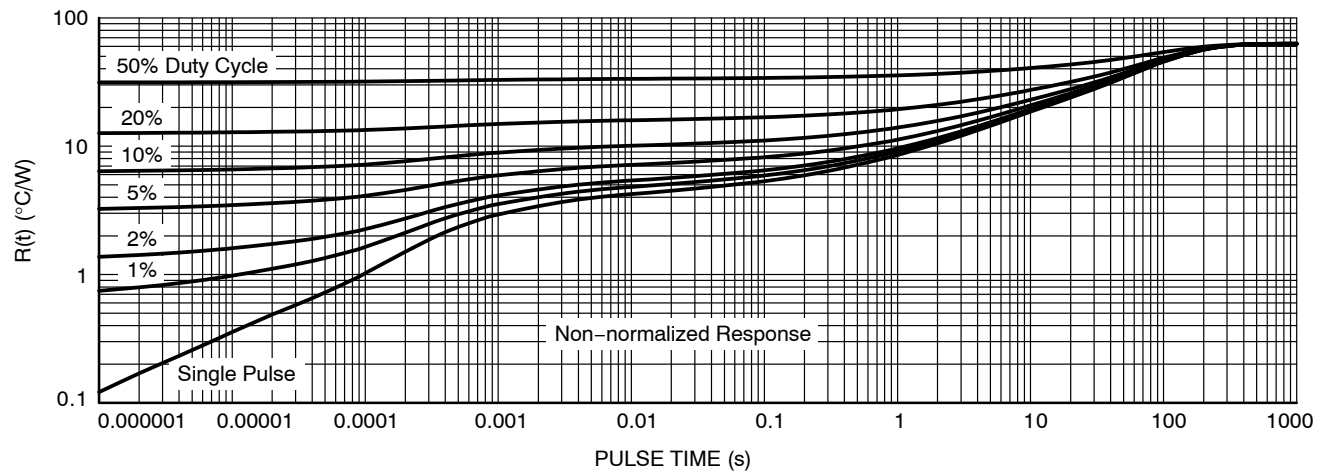

Figure 27. Duty Cycle for 1 inch² (645 mm²) Spreader Board, DPAK 3-Lead

NCV4274C

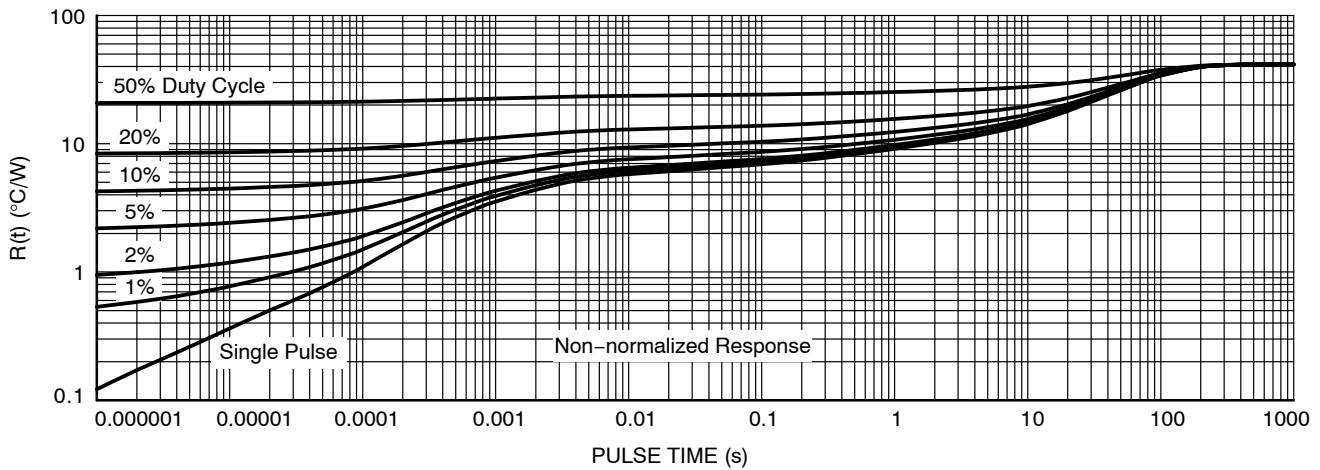

Figure 28. Duty Cycle for 1 inch² (645 mm²) Spreader Board, D²PAK 3-Lead

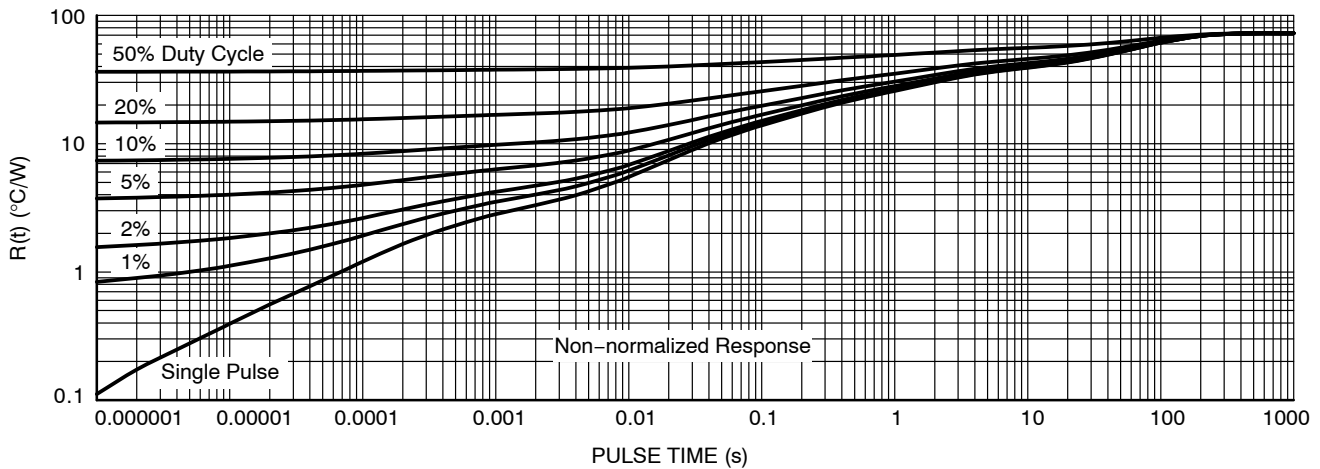

Figure 29. Duty Cycle for 1 inch² (645 mm²) Spreader Board, SOT 223-Lead

ORDERING INFORMATION

Device*	Output Voltage Accuracy	Output Voltage	Package	Shipping†
NCV4274CDT33RKG	2%	3.3 V	DPAK (Pb-Free)	2500 / Tape & Reel
NCV4274CDT50RKG	2%	5.0 V	DPAK (Pb-Free)	2500 / Tape & Reel
NCV4274CST33T3G	2%	3.3 V	SOT-223 (Pb-Free)	4000 / Tape & Reel
NCV4274CST50T3G	2%	5.0 V	SOT-223 (Pb-Free)	4000 / Tape & Reel

DISCONTINUED (Note 5)

NCV4274CDS33R4G	2%	3.3 V	D2PAK (Pb-Free)	800 / Tape & Reel
NCV4274CDS50R4G	2%	5.0 V	D2PAK (Pb-Free)	800 / Tape & Reel

†For information on tape and reel specifications, including part orientation and tape sizes, please refer to our Tape and Reel Packaging Specifications Brochure, BRD8011/D.

*NCV Prefix for Automotive and Other Applications Requiring Unique Site and Control Change Requirements; AEC-Q100 Qualified and PPAP Capable.

5. **DISCONTINUED:** These devices are not recommended for new design. Please contact your **onsemi** representative for information. The most current information on these devices may be available on www.onsemi.com.

MECHANICAL CASE OUTLINE

PACKAGE DIMENSIONS

ON Semiconductor®



SCALE 1:1

SOT-223 (TO-261)
CASE 318E-04
ISSUE R

DATE 02 OCT 2018

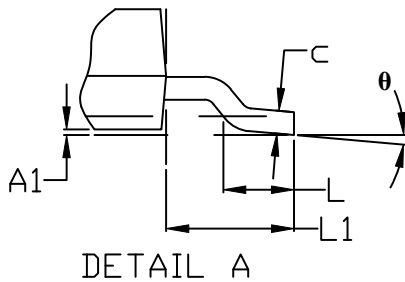
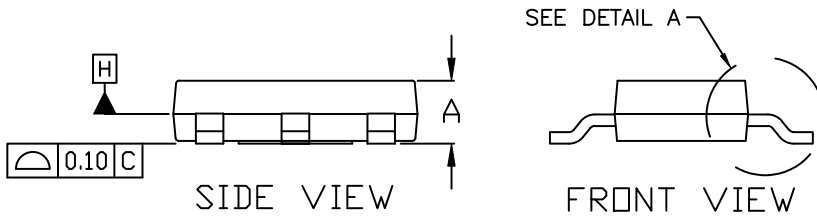

NOTES:

1. DIMENSIONING AND TOLERANCING PER ASME Y14.5M, 1994.
2. CONTROLLING DIMENSION: MILLIMETERS
3. DIMENSIONS D & E DO NOT INCLUDE MOLD FLASH, PROTRUSIONS OR GATE BURRS. MOLD FLASH, PROTRUSIONS OR GATE BURRS SHALL NOT EXCEED 0.200MM PER SIDE.
4. DATUMS A AND B ARE DETERMINED AT DATUM H.
5. A1 IS DEFINED AS THE VERTICAL DISTANCE FROM THE SEATING PLANE TO THE LOWEST POINT OF THE PACKAGE BODY.
6. POSITIONAL TOLERANCE APPLIES TO DIMENSIONS b AND b1.

MILLIMETERS			
DIM	MIN.	NOM.	MAX.
A	1.50	1.63	1.75
A1	0.02	0.06	0.10
b	0.60	0.75	0.89
b1	2.90	3.06	3.20
c	0.24	0.29	0.35
D	6.30	6.50	6.70
E	3.30	3.50	3.70
e	2.30 BSC		
L	0.20	---	---
L1	1.50	1.75	2.00
He	6.70	7.00	7.30
θ	0°	---	10°

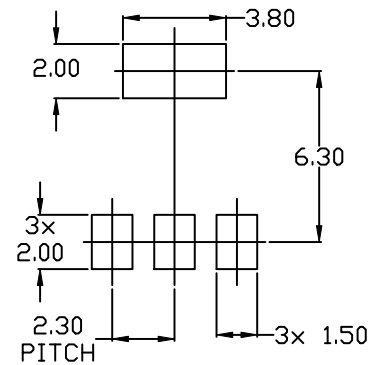

DOCUMENT NUMBER:	98ASB42680B	Electronic versions are uncontrolled except when accessed directly from the Document Repository. Printed versions are uncontrolled except when stamped "CONTROLLED COPY" in red.
DESCRIPTION:	SOT-223 (TO-261)	PAGE 1 OF 2

ON Semiconductor and are trademarks of Semiconductor Components Industries, LLC dba ON Semiconductor or its subsidiaries in the United States and/or other countries. ON Semiconductor reserves the right to make changes without further notice to any products herein. ON Semiconductor makes no warranty, representation or guarantee regarding the suitability of its products for any particular purpose, nor does ON Semiconductor assume any liability arising out of the application or use of any product or circuit, and specifically disclaims any and all liability, including without limitation special, consequential or incidental damages. ON Semiconductor does not convey any license under its patent rights nor the rights of others.

SOT-223 (TO-261)
CASE 318E-04
ISSUE R

DATE 02 OCT 2018

- | | | | | |
|--|---|---|---|---|
| STYLE 1:
PIN 1. BASE
2. COLLECTOR
3. EMITTER
4. COLLECTOR | STYLE 2:
PIN 1. ANODE
2. CATHODE
3. NC
4. CATHODE | STYLE 3:
PIN 1. GATE
2. DRAIN
3. SOURCE
4. DRAIN | STYLE 4:
PIN 1. SOURCE
2. DRAIN
3. GATE
4. DRAIN | STYLE 5:
PIN 1. DRAIN
2. GATE
3. SOURCE
4. GATE |
| STYLE 6:
PIN 1. RETURN
2. INPUT
3. OUTPUT
4. INPUT | STYLE 7:
PIN 1. ANODE 1
2. CATHODE
3. ANODE 2
4. CATHODE | STYLE 8:
CANCELLED | STYLE 9:
PIN 1. INPUT
2. GROUND
3. LOGIC
4. GROUND | STYLE 10:
PIN 1. CATHODE
2. ANODE
3. GATE
4. ANODE |
| STYLE 11:
PIN 1. MT 1
2. MT 2
3. GATE
4. MT 2 | STYLE 12:
PIN 1. INPUT
2. OUTPUT
3. NC
4. OUTPUT | STYLE 13:
PIN 1. GATE
2. COLLECTOR
3. EMITTER
4. COLLECTOR | | |

**GENERIC
 MARKING DIAGRAM***

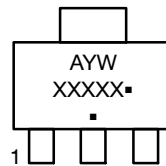

- A = Assembly Location
- Y = Year
- W = Work Week
- XXXXX = Specific Device Code
- = Pb-Free Package

(Note: Microdot may be in either location)

*This information is generic. Please refer to device data sheet for actual part marking. Pb-Free indicator, "G" or microdot "▪", may or may not be present. Some products may not follow the Generic Marking.

DOCUMENT NUMBER:	98ASB42680B	Electronic versions are uncontrolled except when accessed directly from the Document Repository. Printed versions are uncontrolled except when stamped "CONTROLLED COPY" in red.
DESCRIPTION:	SOT-223 (TO-261)	PAGE 2 OF 2

ON Semiconductor and  are trademarks of Semiconductor Components Industries, LLC dba ON Semiconductor or its subsidiaries in the United States and/or other countries. ON Semiconductor reserves the right to make changes without further notice to any products herein. ON Semiconductor makes no warranty, representation or guarantee regarding the suitability of its products for any particular purpose, nor does ON Semiconductor assume any liability arising out of the application or use of any product or circuit, and specifically disclaims any and all liability, including without limitation special, consequential or incidental damages. ON Semiconductor does not convey any license under its patent rights nor the rights of others.

MECHANICAL CASE OUTLINE PACKAGE DIMENSIONS

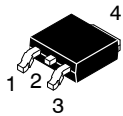

DPAK (SINGLE GAUGE) CASE 369C ISSUE G

DATE 31 MAY 2023

SCALE 1:1

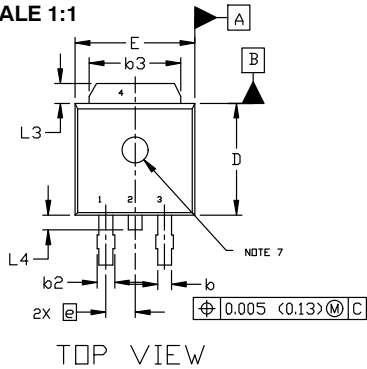

TOP VIEW

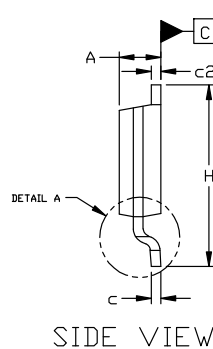

SIDE VIEW

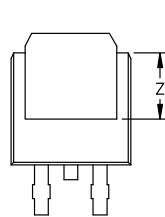

BOTTOM VIEW

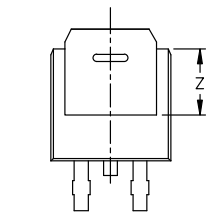
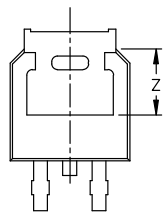

BOTTOM VIEW

ALTERNATE CONSTRUCTIONS

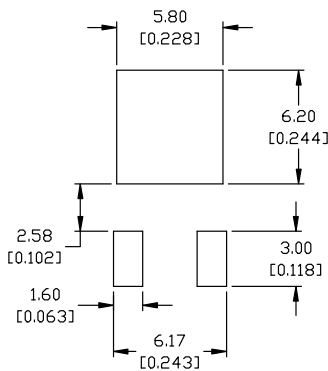

RECOMMENDED MOUNTING FOOTPRINT*

*FOR ADDITIONAL INFORMATION ON OUR Pb-FREE STRATEGY AND SOLDERING DETAILS, PLEASE DOWNLOAD THE ON SEMICONDUCTOR SOLDERING AND MOUNTING TECHNIQUES REFERENCE MANUAL, SOLDERRM/D.

- | | | | | |
|--|--|---|---|--|
| STYLE 1:
PIN 1. BASE
2. COLLECTOR
3. EMITTER
4. COLLECTOR | STYLE 2:
PIN 1. GATE
2. DRAIN
3. SOURCE
4. DRAIN | STYLE 3:
PIN 1. ANODE
2. CATHODE
3. ANODE
4. CATHODE | STYLE 4:
PIN 1. CATHODE
2. ANODE
3. GATE
4. ANODE | STYLE 5:
PIN 1. GATE
2. ANODE
3. CATHODE
4. ANODE |
| STYLE 6:
PIN 1. MT1
2. MT2
3. GATE
4. MT2 | STYLE 7:
PIN 1. GATE
2. COLLECTOR
3. EMITTER
4. COLLECTOR | STYLE 8:
PIN 1. N/C
2. CATHODE
3. ANODE
4. CATHODE | STYLE 9:
PIN 1. ANODE
2. CATHODE
3. RESISTOR ADJUST
4. CATHODE | STYLE 10:
PIN 1. CATHODE
2. ANODE
3. CATHODE
4. ANODE |

NOTES:

- DIMENSIONING AND TOLERANCING ASME Y14.5M, 1994.
- CONTROLLING DIMENSION: INCHES
- THERMAL PAD CONTOUR OPTIONAL WITHIN DIMENSIONS b3, L3, AND Z.
- DIMENSIONS D AND E DO NOT INCLUDE MOLD FLASH, PROTRUSIONS, OR BURRS. MOLD FLASH, PROTRUSIONS, OR GATE BURRS SHALL NOT EXCEED 0.006 INCHES PER SIDE.
- DIMENSIONS D AND E ARE DETERMINED AT THE OUTERMOST EXTREMES OF THE PLASTIC BODY.
- DATUMS A AND B ARE DETERMINED AT DATUM PLANE H.
- OPTIONAL MOLD FEATURE.

DIM	INCHES		MILLIMETERS	
	MIN.	MAX.	MIN.	MAX.
A	0.086	0.094	2.18	2.38
A1	0.000	0.005	0.00	0.13
b	0.025	0.035	0.63	0.89
b2	0.028	0.045	0.72	1.14
b3	0.180	0.215	4.57	5.46
c	0.018	0.024	0.46	0.61
c2	0.018	0.024	0.46	0.61
D	0.235	0.245	5.97	6.22
E	0.250	0.265	6.35	6.73
e	0.090	BSC	2.29	BSC
H	0.370	0.410	9.40	10.41
L	0.055	0.070	1.40	1.78
L1	0.114	REF	2.90	REF
L2	0.020	BSC	0.51	BSC
L3	0.035	0.050	0.89	1.27
L4	----	0.040	---	1.01
Z	0.155	----	3.93	---

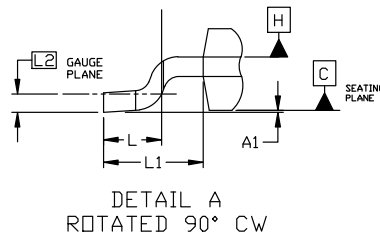

DETAIL A
ROTATED 90° CW

GENERIC MARKING DIAGRAM*

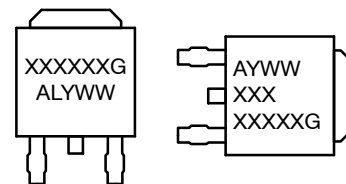

- IC**
 XXXXXX = Device Code
 A = Assembly Location
 L = Wafer Lot
 Y = Year
 WW = Work Week
 G = Pb-Free Package
- Discrete**
 AYWW
 XXX
 XXXXXG

*This information is generic. Please refer to device data sheet for actual part marking. Pb-Free indicator, "G" or microdot "•", may or may not be present. Some products may not follow the Generic Marking.

DOCUMENT NUMBER:	98AON10527D	Electronic versions are uncontrolled except when accessed directly from the Document Repository. Printed versions are uncontrolled except when stamped "CONTROLLED COPY" in red.
DESCRIPTION:	DPAK (SINGLE GAUGE)	PAGE 1 OF 1

onsemi and onsemi are trademarks of Semiconductor Components Industries, LLC dba onsemi or its subsidiaries in the United States and/or other countries. onsemi reserves the right to make changes without further notice to any products herein. onsemi makes no warranty, representation or guarantee regarding the suitability of its products for any particular purpose, nor does onsemi assume any liability arising out of the application or use of any product or circuit, and specifically disclaims any and all liability, including without limitation special, consequential or incidental damages. onsemi does not convey any license under its patent rights nor the rights of others.

MECHANICAL CASE OUTLINE

PACKAGE DIMENSIONS

ON Semiconductor®

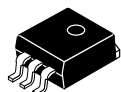

SCALE 1:1

D2PAK
CASE 418AF
ISSUE E

DATE 15 SEP 2015

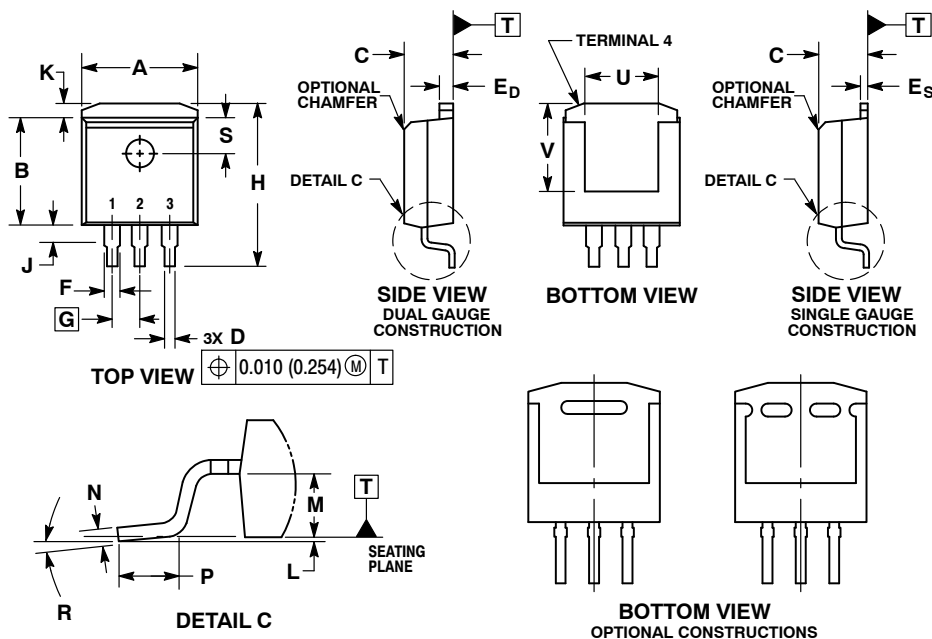

- NOTES:
- DIMENSIONING AND TOLERANCING PER ANSI Y14.5M, 1982.
 - CONTROLLING DIMENSION: INCHES.
 - TAB CONTOUR OPTIONAL WITHIN DIMENSIONS A AND K.
 - DIMENSIONS U AND V ESTABLISH A MINIMUM MOUNTING SURFACE FOR TERMINAL 4.
 - DIMENSIONS A AND B DO NOT INCLUDE MOLD FLASH OR GATE PROTRUSIONS. MOLD FLASH AND GATE PROTRUSIONS NOT TO EXCEED 0.025 (0.635) MAXIMUM.
 - SINGLE GAUGE DESIGN WILL BE SHIPPED AFTER FPCN EXPIRATION IN OCTOBER 2011.

DIM	INCHES		MILLIMETERS	
	MIN	MAX	MIN	MAX
A	0.386	0.403	9.804	10.236
B	0.356	0.368	9.042	9.347
C	0.170	0.180	4.318	4.572
D	0.026	0.036	0.660	0.914
E _D	0.045	0.055	1.143	1.397
E _S	0.018	0.026	0.457	0.660
F	0.051 REF		1.295 REF	
G	0.100 BSC		2.540 BSC	
H	0.539	0.579	13.691	14.707
J	0.125 MAX		3.175 MAX	
K	0.050 REF		1.270 REF	
L	0.000	0.010	0.000	0.254
M	0.088	0.102	2.235	2.591
N	0.018	0.026	0.457	0.660
P	0.058	0.078	1.473	1.981
R	0°	8°	0°	8°
S	0.116 REF		2.946 REF	
U	0.200 MIN		5.080 MIN	
V	0.250 MIN		6.350 MIN	

SOLDERING FOOTPRINT*

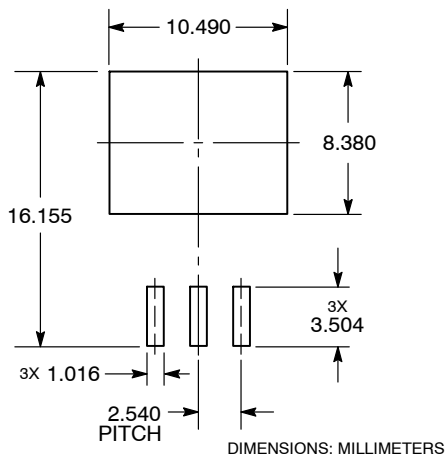

*For additional information on our Pb-Free strategy and soldering details, please download the ON Semiconductor Soldering and Mounting Techniques Reference Manual, SOLDERRM/D.

GENERIC MARKING DIAGRAM*

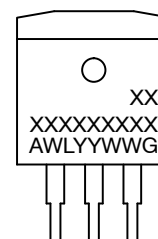

- XXXXX = Specific Device Code
- A = Assembly Location
- WL = Wafer Lot
- YY = Year
- WW = Work Week
- G = Pb-Free Package

*This information is generic. Please refer to device data sheet for actual part marking. Pb-Free indicator, "G", may or not be present.

DOCUMENT NUMBER:	98AON21981D	Electronic versions are uncontrolled except when accessed directly from the Document Repository. Printed versions are uncontrolled except when stamped "CONTROLLED COPY" in red.
DESCRIPTION:	D2PAK	PAGE 1 OF 1

ON Semiconductor and ON are trademarks of Semiconductor Components Industries, LLC dba ON Semiconductor or its subsidiaries in the United States and/or other countries. ON Semiconductor reserves the right to make changes without further notice to any products herein. ON Semiconductor makes no warranty, representation or guarantee regarding the suitability of its products for any particular purpose, nor does ON Semiconductor assume any liability arising out of the application or use of any product or circuit, and specifically disclaims any and all liability, including without limitation special, consequential or incidental damages. ON Semiconductor does not convey any license under its patent rights nor the rights of others.

onsemi, **Onsemi**, and other names, marks, and brands are registered and/or common law trademarks of Semiconductor Components Industries, LLC dba "**onsemi**" or its affiliates and/or subsidiaries in the United States and/or other countries. **onsemi** owns the rights to a number of patents, trademarks, copyrights, trade secrets, and other intellectual property. A listing of **onsemi**'s product/patent coverage may be accessed at www.onsemi.com/site/pdf/Patent-Marking.pdf. **onsemi** reserves the right to make changes at any time to any products or information herein, without notice. The information herein is provided "as-is" and **onsemi** makes no warranty, representation or guarantee regarding the accuracy of the information, product features, availability, functionality, or suitability of its products for any particular purpose, nor does **onsemi** assume any liability arising out of the application or use of any product or circuit, and specifically disclaims any and all liability, including without limitation special, consequential or incidental damages. Buyer is responsible for its products and applications using **onsemi** products, including compliance with all laws, regulations and safety requirements or standards, regardless of any support or applications information provided by **onsemi**. "Typical" parameters which may be provided in **onsemi** data sheets and/or specifications can and do vary in different applications and actual performance may vary over time. All operating parameters, including "Typicals" must be validated for each customer application by customer's technical experts. **onsemi** does not convey any license under any of its intellectual property rights nor the rights of others. **onsemi** products are not designed, intended, or authorized for use as a critical component in life support systems or any FDA Class 3 medical devices or medical devices with a same or similar classification in a foreign jurisdiction or any devices intended for implantation in the human body. Should Buyer purchase or use **onsemi** products for any such unintended or unauthorized application, Buyer shall indemnify and hold **onsemi** and its officers, employees, subsidiaries, affiliates, and distributors harmless against all claims, costs, damages, and expenses, and reasonable attorney fees arising out of, directly or indirectly, any claim of personal injury or death associated with such unintended or unauthorized use, even if such claim alleges that **onsemi** was negligent regarding the design or manufacture of the part. **onsemi** is an Equal Opportunity/Affirmative Action Employer. This literature is subject to all applicable copyright laws and is not for resale in any manner.

ADDITIONAL INFORMATION

TECHNICAL PUBLICATIONS:

Technical Library: www.onsemi.com/design/resources/technical-documentation
onsemi Website: www.onsemi.com

ONLINE SUPPORT: www.onsemi.com/support

For additional information, please contact your local Sales Representative at www.onsemi.com/support/sales