

# NCS3402

## Dual Nano-power Open Drain Output Comparator

The NCS3402 is a nano-power comparator consuming only 470 nA per channel supply current, which make this device ideal for battery power and wireless handset applications.

The NCS3402 has a minimum operating supply voltage of 2.7 V over the extended industrial temperature range ( $T_A = -40^{\circ}\text{C}$  to  $125^{\circ}\text{C}$ ), while having an input common-mode range of  $-0.1$  to  $V_{DD} + 5$  V.

The ultra low supply current makes the NCS3402 an ideal choice for battery powered and portable applications where quiescent current is the primary concern. Reverse battery protection guards the amplifier from an over-current condition due to improper battery installation. For harsh environments, the inputs can be taken 5 V above the positive supply rail without damage to the device.

### Features

- Low Supply Current: 470 nA/Per Channel
  - ◆ Input Common-Mode Range exceeds the rails
  - ◆  $-0.1$  V to  $V_{DD} + 5$  V
- Supply Voltage Range: 2.7 V to 16 V
- Reverse Battery Protection Up to 18 V
- Open Drain CMOS Output Stage
- Specified Temperature Range
  - ◆  $-40^{\circ}\text{C}$  to  $125^{\circ}\text{C}$
- This is a Pb-Free Device

### Typical Applications

- Voltage Sense Circuit
- PSU Monitoring Circuit
- Wireless Handsets
- Portable Medical Equipment



**ON Semiconductor**<sup>®</sup>

<http://onsemi.com>

### MARKING DIAGRAMS



A = Assembly Location  
L = Wafer Lot  
Y = Year  
W = Work Week  
▪ = Pb-Free Package

(Note: Microdot may be in either location)

### PIN CONNECTIONS

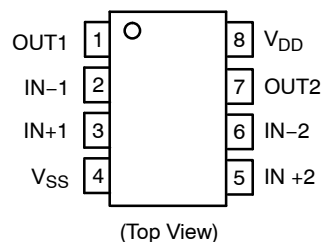

(Top View)

### ORDERING INFORMATION

See detailed ordering and shipping information in the package dimensions section on page 7 of this data sheet.

# NCS3402

## PIN FUNCTION DESCRIPTION

Pin No.	Pin Name	Description
1	OUT1	Channel 1 Output
2	IN-1	Channel 1 Inverting Input
3	IN+2	Channel 2 Non-Inverting Input
4	V <sub>SS</sub>	Negative Power Supply
5	IN+2	Channel 2 Non-Inverting Input
6	IN-2	Channel 2 Inverting Input
7	OUT2	Channel 2 Output
8	V <sub>DD</sub>	Positive Power Supply

## ABSOLUTE MAXIMUM RATINGS

Rating	Symbol	Value	Unit
Supply Voltage	V <sub>DD</sub>	17	V
Differential Input Voltage	V <sub>ID</sub>	±20	V
Input Voltage Range (Notes 1 and 2)	V <sub>IN</sub>	0 to V <sub>CC</sub> + 5	V
Input Current Range	I <sub>IN</sub>	±10	mA
Output Current Range	I <sub>O</sub>	±10	mA
Operating Free-Air Temperature Range	T <sub>A</sub>	-40 to +125	°C
Maximum Junction Temperature	T <sub>J</sub>	150	°C
Storage Temperature Range	T <sub>STG</sub>	-65 to 150	°C
Lead Temperature 1.6 mm (1/16 inch) from case for 10 seconds	T <sub>SLD</sub>	260	°C

Stresses exceeding Maximum Ratings may damage the device. Maximum Ratings are stress ratings only. Functional operation above the Recommended Operating Conditions is not implied. Extended exposure to stresses above the Recommended Operating Conditions may affect device reliability.

1. All voltage values, except differential voltages, are respect to GND
2. Input voltage range is limited to 20V or V<sub>CC</sub> +5 V whichever is smaller

## ESD RATINGS

Rating	Symbol	Value	Unit
Human Body Model	HBM	2000	V
Machine Model	MM	200	V

## THERMAL CHARACTERISTICS (Note 3)

Rating	Symbol	Value	Unit
Thermal Characteristics Thermal Resistance, Junction-to-Air SOIC8	R <sub>θJA</sub>	176	°C/W

3. Power dissipation must be considered to ensure the maximum junction temperature (θ<sub>JA</sub>) is not exceeded.

## RECOMMENDED OPERATING CONDITIONS

Parameter	Symbol	Min	Max	Unit	
Supply voltage	V <sub>DD</sub>	Single supply	2.7	16	V
		Split supply	±1.35	±8	
Common-mode input voltage range	V <sub>ICR</sub>	-0.1	V <sub>DD</sub> +5	V	
Operating free-air temperature	T <sub>A</sub>	-40	125	°C	

# NCS3402

## DC PERFORMANCE ELECTRICAL CHARACTERISTICS AT SPECIFIED OPERATING FREE-AIR TEMPERATURE,

$V_S = 2.7\text{ V}, 5\text{ V}, 15\text{ V}$  (unless otherwise noted)

Parameter	Symbol	Testing Conditions	$T_A$	Min	Typ	Max	Unit
Input offset voltage	$V_{IO}$	$V_{CM} = V_S/2, R_S = 50\ \Omega, R_P = 1\text{ M}\Omega$	25°C		250	3600	$\mu\text{V}$
			Full range			4400	
Offset voltage drift	$\Delta V_{IO}$		25°C		3		$\mu\text{V}/^\circ\text{C}$
Common-mode rejection ratio	CMRR	$V_{CM} = 0\text{ to }2.7\text{ V}, R_S = 50\ \Omega$	25°C	55	72		dB
			Full range	50			
		$V_{CM} = 0\text{ to }5\text{ V}, R_S = 50\ \Omega$	25°C	60	76		
			Full range	55			
		$V_{CM} = 0\text{ to }15\text{ V}, R_S = 50\ \Omega$	25°C	65	88		
			Full range	60			
Large-signal differential voltage amplification	$A_{VD}$	$R_P = 1\text{ M}\Omega$	25°C		1000		V/mV

## INPUT/OUTPUT CHARACTERISTICS SPECIFIED OPERATING FREE-AIR TEMPERATURE,

$V_S = 2.7\text{ V}, 5\text{ V}, 15\text{ V}$  (unless otherwise noted)

Input offset current (Note 4)	$I_{IO}$	$V_{CM} = V_S/2, R_P = 1\text{ M}\Omega, R_S = 50\ \Omega$	25°C		20	100	pA
			Full range			1000	
Input bias current (Note 4)	$I_{IB}$		25°C		80	250	pA
			Full range			3000	
Differential input resistance	$R_{ID}$	$V_{in} = V_S/2$	25°C		300		M $\Omega$
High-impedance output leakage current	$I_{OZ}$	$V_{CM} = V_S/2, V_O = V_{CC}, V_{ID} = 1\text{ V}$	25°C		50		pA
Low-level output voltage	$V_{OL}$	$V_{CM} = V_S/2, I_{OL} = 2\ \mu\text{A}, V_{ID} = -1\text{ V}$	25°C		8		mV
			25°C		80	200	
			Full range			300	

## POWER SUPPLY SPECIFIED OPERATING FREE-AIR TEMPERATURE, $V_{CC} = 2.7\text{ V}, 5\text{ V}, 15\text{ V}$ (unless otherwise noted)

Supply current (per channel)	$I_{CC}$	$R_P = \text{No pullup}$	Output state low	25°C		470	550	nA
				Full range			750	
			Output state high	25°C		560	640	
				Full range			950	
Power supply rejection ratio	PSRR	$V_{CM} = V_S/2, \text{No load}$	$V_{CC} = 2.7\text{ V to }5\text{ V}$	25°C	75	100		dB
				Full range	70			
			$V_{CC} = 5\text{ V to }15\text{ V}$	25°C	85	105		
				Full range	80			

4. Guaranteed by design or characterization.

# NCS3402

## SWITCHING CHARACTERISTICS AT RECOMMENDED OPERATING CONDITIONS,

$V_{CC} = 2.7\text{ V}, 5\text{ V}, 15\text{ V}, T_A = 25^\circ\text{C}$  (unless otherwise noted)

Parameter	Symbol	Testing Conditions	$T_A$	Min	Typ	Max	Unit	
Propagation delay time, low-to-high-level	$t_{(PLH)}$	$f = 10\text{ kHz},$ $V_{STEP} = 100\text{ mV},$ $R_P = 1\text{ M}\Omega,$ $C_L = 10\text{ pF}$	25°C		220		$\mu\text{s}$	
					85			
					30			
Propagation delay time, high-to-low-level output	$t_{(PHL)}$			25°C		250		
						55		
						18		
Fall time	$t_f$	$R_P = 1\text{ M}\Omega, C_L = 10\text{ pF}$		25°C		5		$\mu\text{s}$

TYPICAL CHARACTERISTICS

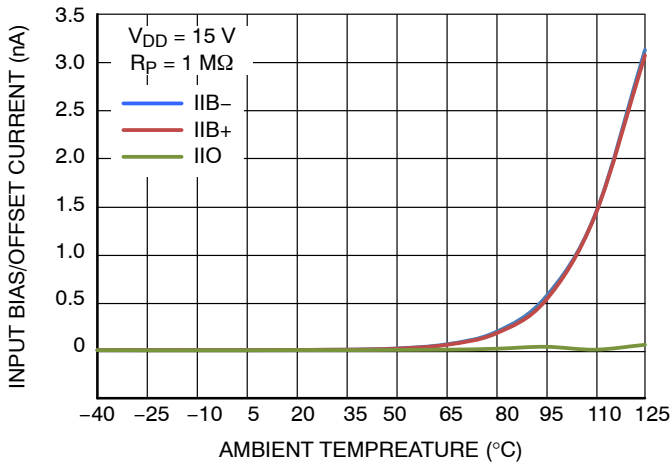

Figure 1. Input Bias/Offset Current vs. Temperature

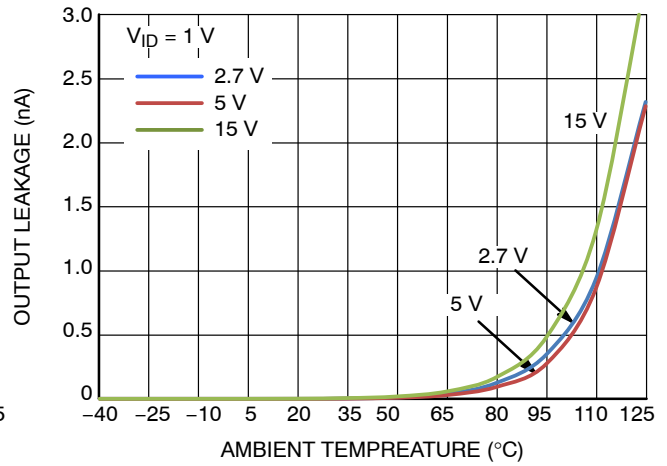

Figure 2. Open Drain Leakage Current vs. Temperature

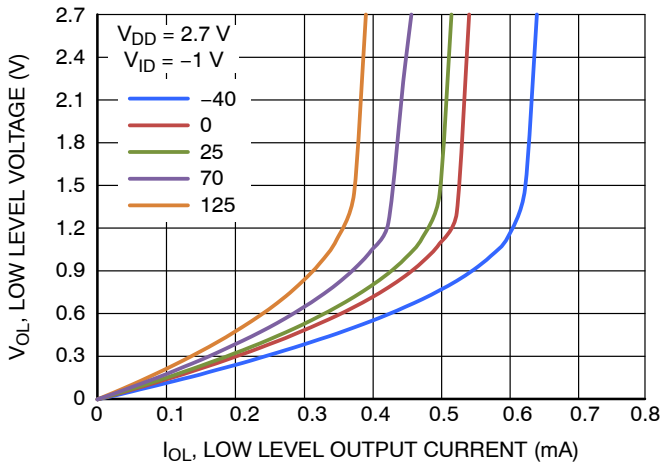

Figure 3. Low Level Output Voltage vs. Low Level Output Current

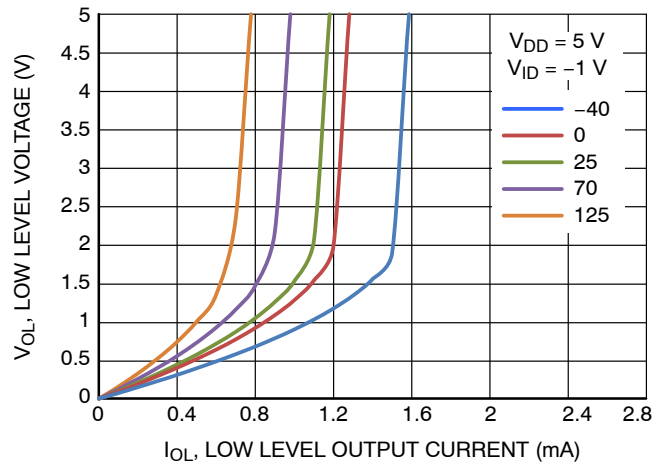

Figure 4. Low Level Output Voltage vs. Low Level Output Current

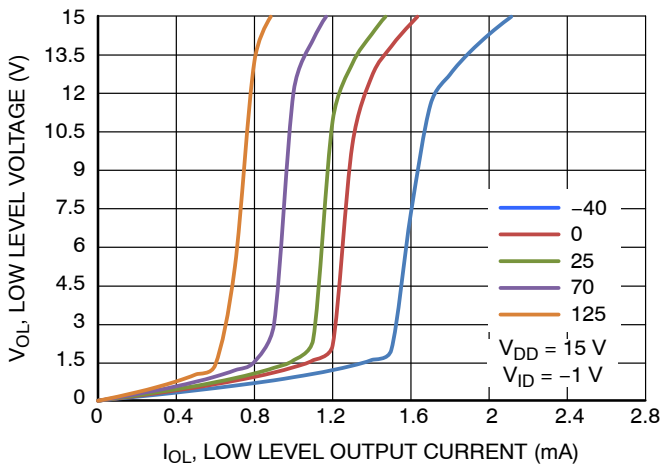

Figure 5. Low Level Output Voltage vs. Low Level Output Current

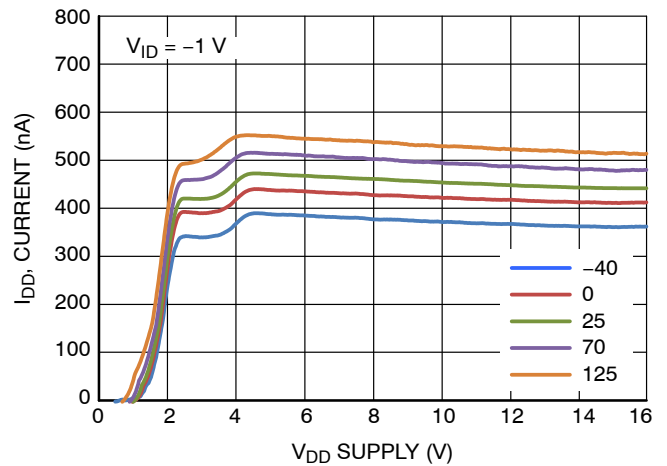

Figure 6.  $I_{DD}$  vs.  $V_{DD}$  vs. Temperature

TYPICAL CHARACTERISTICS

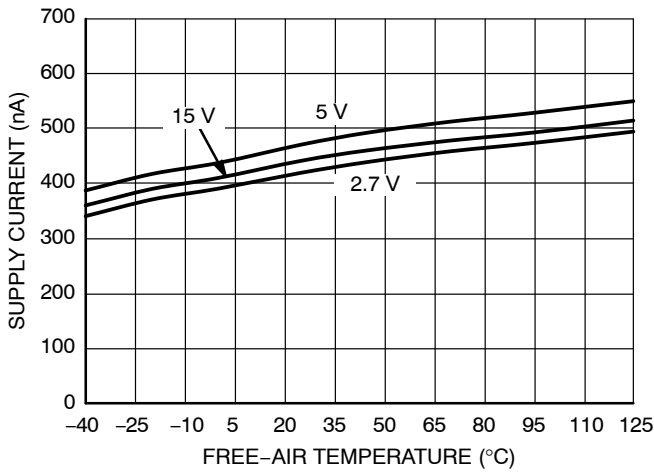

Figure 7. Supply Current vs. Free-Air Temperature

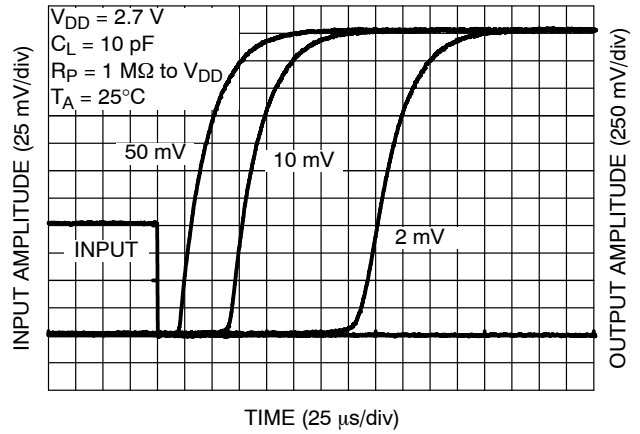

Figure 8. Propagation Delay L-H (2.7 V)

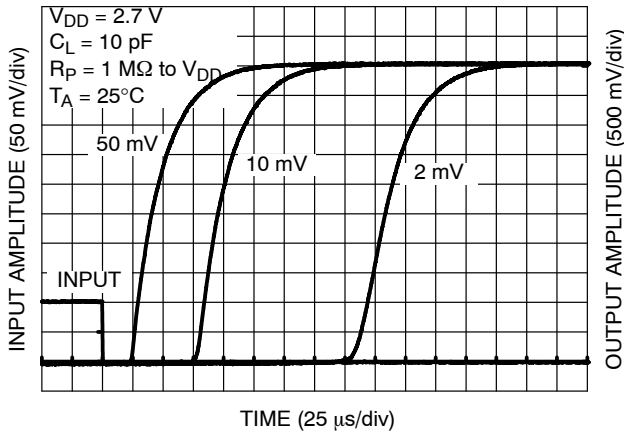

Figure 9. Propagation Delay L-H (5 V)

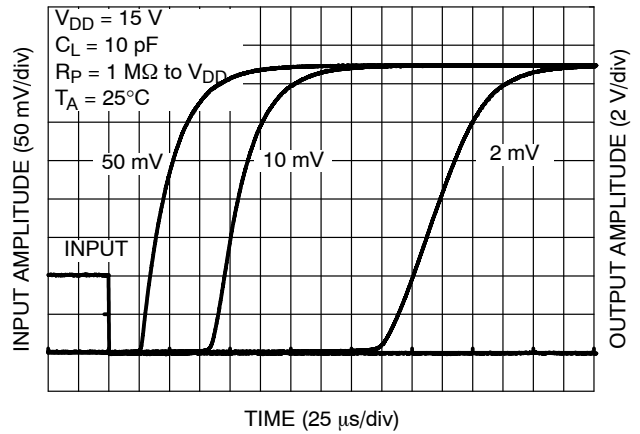

Figure 10. Propagation Delay L-H (15 V)

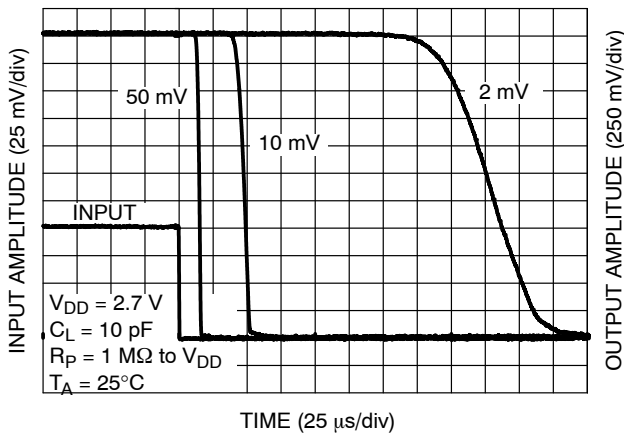

Figure 11. Propagation Delay H-L (2.7 V)

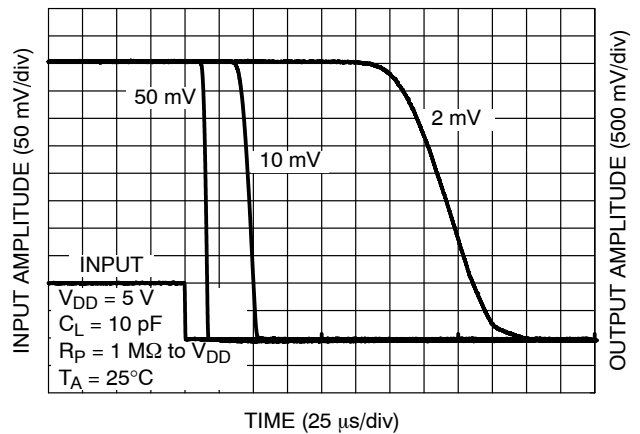

Figure 12. Propagation Delay H-L (5 V)

# NCS3402

## TYPICAL CHARACTERISTICS

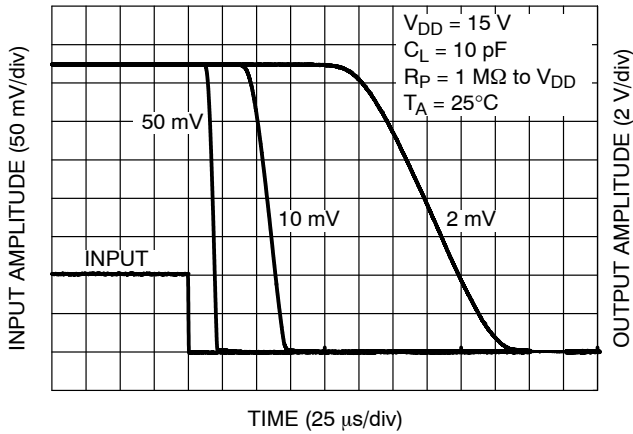

Figure 13. Propagation Delay H-L (15 V)

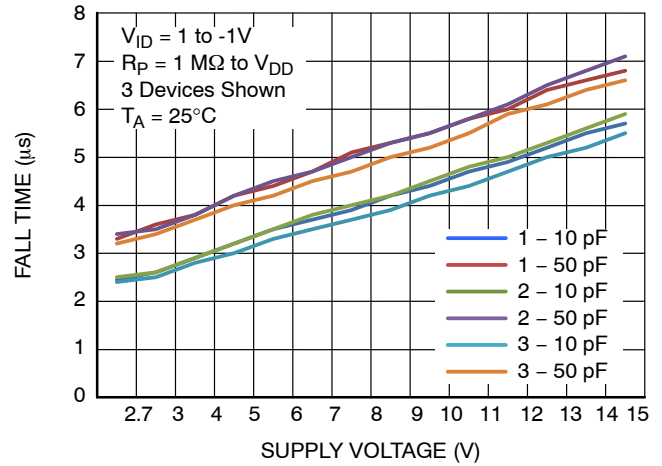

Figure 14. Output Fall Time vs. Power Supply

### ORDERING INFORMATION

Device	Package	Shipping <sup>†</sup>
NCS3402DR2G	SOIC-8 (Pb-Free)	2500 / Tape & Reel

<sup>†</sup>For information on tape and reel specifications, including part orientation and tape sizes, please refer to our Tape and Reel Packaging Specifications Brochure, BRD8011/D.



SCALE 1:1

SOIC-8 NB  
CASE 751-07  
ISSUE AK

DATE 16 FEB 2011

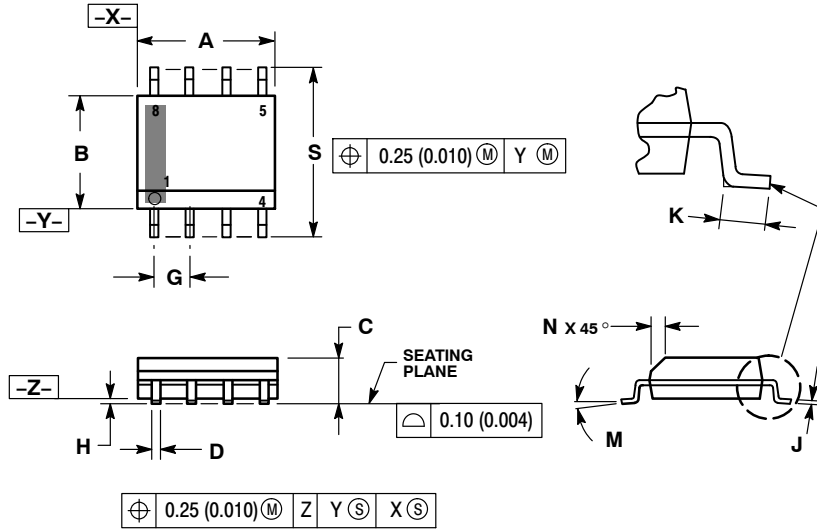

- NOTES:
1. DIMENSIONING AND TOLERANCING PER ANSI Y14.5M, 1982.
  2. CONTROLLING DIMENSION: MILLIMETER.
  3. DIMENSION A AND B DO NOT INCLUDE MOLD PROTRUSION.
  4. MAXIMUM MOLD PROTRUSION 0.15 (0.006) PER SIDE.
  5. DIMENSION D DOES NOT INCLUDE DAMBAR PROTRUSION. ALLOWABLE DAMBAR PROTRUSION SHALL BE 0.127 (0.005) TOTAL IN EXCESS OF THE D DIMENSION AT MAXIMUM MATERIAL CONDITION.
  6. 751-01 THRU 751-06 ARE OBSOLETE. NEW STANDARD IS 751-07.

DIM	MILLIMETERS		INCHES	
	MIN	MAX	MIN	MAX
A	4.80	5.00	0.189	0.197
B	3.80	4.00	0.150	0.157
C	1.35	1.75	0.053	0.069
D	0.33	0.51	0.013	0.020
G	1.27 BSC		0.050 BSC	
H	0.10	0.25	0.004	0.010
J	0.19	0.25	0.007	0.010
K	0.40	1.27	0.016	0.050
M	0°	8°	0°	8°
N	0.25	0.50	0.010	0.020
S	5.80	6.20	0.228	0.244

SOLDERING FOOTPRINT\*



\*For additional information on our Pb-Free strategy and soldering details, please download the onsemi Soldering and Mounting Techniques Reference Manual, SOLDERRM/D.

GENERIC MARKING DIAGRAM\*



XXXXXX = Specific Device Code  
A = Assembly Location  
L = Wafer Lot  
Y = Year  
W = Work Week  
▪ = Pb-Free Package

XXXXXX = Specific Device Code  
A = Assembly Location  
Y = Year  
WW = Work Week  
▪ = Pb-Free Package

\*This information is generic. Please refer to device data sheet for actual part marking. Pb-Free indicator, "G" or microdot "▪", may or may not be present. Some products may not follow the Generic Marking.

STYLES ON PAGE 2

DOCUMENT NUMBER:	98ASB42564B	Electronic versions are uncontrolled except when accessed directly from the Document Repository. Printed versions are uncontrolled except when stamped "CONTROLLED COPY" in red.
DESCRIPTION:	SOIC-8 NB	PAGE 1 OF 2

onsemi and onsemi are trademarks of Semiconductor Components Industries, LLC dba onsemi or its subsidiaries in the United States and/or other countries. onsemi reserves the right to make changes without further notice to any products herein. onsemi makes no warranty, representation or guarantee regarding the suitability of its products for any particular purpose, nor does onsemi assume any liability arising out of the application or use of any product or circuit, and specifically disclaims any and all liability, including without limitation special, consequential or incidental damages. onsemi does not convey any license under its patent rights nor the rights of others.



**SOIC-8 NB**  
**CASE 751-07**  
**ISSUE AK**

DATE 16 FEB 2011

- |   |  |  |  |
|---|--|--|--|
| <p>STYLE 1:<br/> PIN 1. EMITTER<br/> 2. COLLECTOR<br/> 3. COLLECTOR<br/> 4. EMITTER<br/> 5. EMITTER<br/> 6. BASE<br/> 7. BASE<br/> 8. EMITTER</p>   | <p>STYLE 2:<br/> PIN 1. COLLECTOR, DIE, #1<br/> 2. COLLECTOR, #1<br/> 3. COLLECTOR, #2<br/> 4. COLLECTOR, #2<br/> 5. BASE, #2<br/> 6. EMITTER, #2<br/> 7. BASE, #1<br/> 8. EMITTER, #1</p>               | <p>STYLE 3:<br/> PIN 1. DRAIN, DIE #1<br/> 2. DRAIN, #1<br/> 3. DRAIN, #2<br/> 4. DRAIN, #2<br/> 5. GATE, #2<br/> 6. SOURCE, #2<br/> 7. GATE, #1<br/> 8. SOURCE, #1</p>                            | <p>STYLE 4:<br/> PIN 1. ANODE<br/> 2. ANODE<br/> 3. ANODE<br/> 4. ANODE<br/> 5. ANODE<br/> 6. ANODE<br/> 7. ANODE<br/> 8. COMMON CATHODE</p>   |
| <p>STYLE 5:<br/> PIN 1. DRAIN<br/> 2. DRAIN<br/> 3. DRAIN<br/> 4. DRAIN<br/> 5. GATE<br/> 6. GATE<br/> 7. SOURCE<br/> 8. SOURCE</p>   | <p>STYLE 6:<br/> PIN 1. SOURCE<br/> 2. DRAIN<br/> 3. DRAIN<br/> 4. SOURCE<br/> 5. SOURCE<br/> 6. GATE<br/> 7. GATE<br/> 8. SOURCE</p>  | <p>STYLE 7:<br/> PIN 1. INPUT<br/> 2. EXTERNAL BYPASS<br/> 3. THIRD STAGE SOURCE<br/> 4. GROUND<br/> 5. DRAIN<br/> 6. GATE 3<br/> 7. SECOND STAGE Vd<br/> 8. FIRST STAGE Vd</p>                    | <p>STYLE 8:<br/> PIN 1. COLLECTOR, DIE #1<br/> 2. BASE, #1<br/> 3. BASE, #2<br/> 4. COLLECTOR, #2<br/> 5. COLLECTOR, #2<br/> 6. EMITTER, #2<br/> 7. EMITTER, #1<br/> 8. COLLECTOR, #1</p>                              |
| <p>STYLE 9:<br/> PIN 1. EMITTER, COMMON<br/> 2. COLLECTOR, DIE #1<br/> 3. COLLECTOR, DIE #2<br/> 4. EMITTER, COMMON<br/> 5. EMITTER, COMMON<br/> 6. BASE, DIE #2<br/> 7. BASE, DIE #1<br/> 8. EMITTER, COMMON</p> | <p>STYLE 10:<br/> PIN 1. GROUND<br/> 2. BIAS 1<br/> 3. OUTPUT<br/> 4. GROUND<br/> 5. GROUND<br/> 6. BIAS 2<br/> 7. INPUT<br/> 8. GROUND</p>  | <p>STYLE 11:<br/> PIN 1. SOURCE 1<br/> 2. GATE 1<br/> 3. SOURCE 2<br/> 4. GATE 2<br/> 5. DRAIN 2<br/> 6. DRAIN 2<br/> 7. DRAIN 1<br/> 8. DRAIN 1</p>   | <p>STYLE 12:<br/> PIN 1. SOURCE<br/> 2. SOURCE<br/> 3. SOURCE<br/> 4. GATE<br/> 5. DRAIN<br/> 6. DRAIN<br/> 7. DRAIN<br/> 8. DRAIN</p>   |
| <p>STYLE 13:<br/> PIN 1. N.C.<br/> 2. SOURCE<br/> 3. SOURCE<br/> 4. GATE<br/> 5. DRAIN<br/> 6. DRAIN<br/> 7. DRAIN<br/> 8. DRAIN</p>  | <p>STYLE 14:<br/> PIN 1. N-SOURCE<br/> 2. N-GATE<br/> 3. P-SOURCE<br/> 4. P-GATE<br/> 5. P-DRAIN<br/> 6. P-DRAIN<br/> 7. N-DRAIN<br/> 8. N-DRAIN</p>   | <p>STYLE 15:<br/> PIN 1. ANODE 1<br/> 2. ANODE 1<br/> 3. ANODE 1<br/> 4. ANODE 1<br/> 5. CATHODE, COMMON<br/> 6. CATHODE, COMMON<br/> 7. CATHODE, COMMON<br/> 8. CATHODE, COMMON</p>               | <p>STYLE 16:<br/> PIN 1. EMITTER, DIE #1<br/> 2. BASE, DIE #1<br/> 3. EMITTER, DIE #2<br/> 4. BASE, DIE #2<br/> 5. COLLECTOR, DIE #2<br/> 6. COLLECTOR, DIE #2<br/> 7. COLLECTOR, DIE #1<br/> 8. COLLECTOR, DIE #1</p> |
| <p>STYLE 17:<br/> PIN 1. VCC<br/> 2. V2OUT<br/> 3. V1OUT<br/> 4. TXE<br/> 5. RXE<br/> 6. VEE<br/> 7. GND<br/> 8. ACC</p>  | <p>STYLE 18:<br/> PIN 1. ANODE<br/> 2. ANODE<br/> 3. SOURCE<br/> 4. GATE<br/> 5. DRAIN<br/> 6. DRAIN<br/> 7. CATHODE<br/> 8. CATHODE</p>   | <p>STYLE 19:<br/> PIN 1. SOURCE 1<br/> 2. GATE 1<br/> 3. SOURCE 2<br/> 4. GATE 2<br/> 5. DRAIN 2<br/> 6. MIRROR 2<br/> 7. DRAIN 1<br/> 8. MIRROR 1</p>   | <p>STYLE 20:<br/> PIN 1. SOURCE (N)<br/> 2. GATE (N)<br/> 3. SOURCE (P)<br/> 4. GATE (P)<br/> 5. DRAIN<br/> 6. DRAIN<br/> 7. DRAIN<br/> 8. DRAIN</p>   |
| <p>STYLE 21:<br/> PIN 1. CATHODE 1<br/> 2. CATHODE 2<br/> 3. CATHODE 3<br/> 4. CATHODE 4<br/> 5. CATHODE 5<br/> 6. COMMON ANODE<br/> 7. COMMON ANODE<br/> 8. CATHODE 6</p>  | <p>STYLE 22:<br/> PIN 1. I/O LINE 1<br/> 2. COMMON CATHODE/VCC<br/> 3. COMMON CATHODE/VCC<br/> 4. I/O LINE 3<br/> 5. COMMON ANODE/GND<br/> 6. I/O LINE 4<br/> 7. I/O LINE 5<br/> 8. COMMON ANODE/GND</p> | <p>STYLE 23:<br/> PIN 1. LINE 1 IN<br/> 2. COMMON ANODE/GND<br/> 3. COMMON ANODE/GND<br/> 4. LINE 2 IN<br/> 5. LINE 2 OUT<br/> 6. COMMON ANODE/GND<br/> 7. COMMON ANODE/GND<br/> 8. LINE 1 OUT</p> | <p>STYLE 24:<br/> PIN 1. BASE<br/> 2. EMITTER<br/> 3. COLLECTOR/ANODE<br/> 4. COLLECTOR/ANODE<br/> 5. CATHODE<br/> 6. CATHODE<br/> 7. COLLECTOR/ANODE<br/> 8. COLLECTOR/ANODE</p>                                      |
| <p>STYLE 25:<br/> PIN 1. VIN<br/> 2. N/C<br/> 3. REXT<br/> 4. GND<br/> 5. IOUT<br/> 6. IOUT<br/> 7. IOUT<br/> 8. IOUT</p>   | <p>STYLE 26:<br/> PIN 1. GND<br/> 2. dv/dt<br/> 3. ENABLE<br/> 4. ILIMIT<br/> 5. SOURCE<br/> 6. SOURCE<br/> 7. SOURCE<br/> 8. VCC</p>  | <p>STYLE 27:<br/> PIN 1. ILIMIT<br/> 2. OVLO<br/> 3. UVLO<br/> 4. INPUT+<br/> 5. SOURCE<br/> 6. SOURCE<br/> 7. SOURCE<br/> 8. DRAIN</p>  | <p>STYLE 28:<br/> PIN 1. SW_TO_GND<br/> 2. DASIC OFF<br/> 3. DASIC_SW_DET<br/> 4. GND<br/> 5. V_MON<br/> 6. VBULK<br/> 7. VBULK<br/> 8. VIN</p>  |
| <p>STYLE 29:<br/> PIN 1. BASE, DIE #1<br/> 2. EMITTER, #1<br/> 3. BASE, #2<br/> 4. EMITTER, #2<br/> 5. COLLECTOR, #2<br/> 6. COLLECTOR, #2<br/> 7. COLLECTOR, #1<br/> 8. COLLECTOR, #1</p>                        | <p>STYLE 30:<br/> PIN 1. DRAIN 1<br/> 2. DRAIN 1<br/> 3. GATE 2<br/> 4. SOURCE 2<br/> 5. SOURCE 1/DRAIN 2<br/> 6. SOURCE 1/DRAIN 2<br/> 7. SOURCE 1/DRAIN 2<br/> 8. GATE 1</p>                           |  |  |

<b>DOCUMENT NUMBER:</b>	<b>98ASB42564B</b>	Electronic versions are uncontrolled except when accessed directly from the Document Repository. Printed versions are uncontrolled except when stamped "CONTROLLED COPY" in red.
<b>DESCRIPTION:</b>	<b>SOIC-8 NB</b>	<b>PAGE 2 OF 2</b>

**onsemi** and **ONSEMI** are trademarks of Semiconductor Components Industries, LLC dba **onsemi** or its subsidiaries in the United States and/or other countries. **onsemi** reserves the right to make changes without further notice to any products herein. **onsemi** makes no warranty, representation or guarantee regarding the suitability of its products for any particular purpose, nor does **onsemi** assume any liability arising out of the application or use of any product or circuit, and specifically disclaims any and all liability, including without limitation special, consequential or incidental damages. **onsemi** does not convey any license under its patent rights nor the rights of others.

**onsemi**, **Onsemi**, and other names, marks, and brands are registered and/or common law trademarks of Semiconductor Components Industries, LLC dba "**onsemi**" or its affiliates and/or subsidiaries in the United States and/or other countries. **onsemi** owns the rights to a number of patents, trademarks, copyrights, trade secrets, and other intellectual property. A listing of **onsemi**'s product/patent coverage may be accessed at [www.onsemi.com/site/pdf/Patent-Marking.pdf](http://www.onsemi.com/site/pdf/Patent-Marking.pdf). **onsemi** reserves the right to make changes at any time to any products or information herein, without notice. The information herein is provided "as-is" and **onsemi** makes no warranty, representation or guarantee regarding the accuracy of the information, product features, availability, functionality, or suitability of its products for any particular purpose, nor does **onsemi** assume any liability arising out of the application or use of any product or circuit, and specifically disclaims any and all liability, including without limitation special, consequential or incidental damages. Buyer is responsible for its products and applications using **onsemi** products, including compliance with all laws, regulations and safety requirements or standards, regardless of any support or applications information provided by **onsemi**. "Typical" parameters which may be provided in **onsemi** data sheets and/or specifications can and do vary in different applications and actual performance may vary over time. All operating parameters, including "Typicals" must be validated for each customer application by customer's technical experts. **onsemi** does not convey any license under any of its intellectual property rights nor the rights of others. **onsemi** products are not designed, intended, or authorized for use as a critical component in life support systems or any FDA Class 3 medical devices or medical devices with a same or similar classification in a foreign jurisdiction or any devices intended for implantation in the human body. Should Buyer purchase or use **onsemi** products for any such unintended or unauthorized application, Buyer shall indemnify and hold **onsemi** and its officers, employees, subsidiaries, affiliates, and distributors harmless against all claims, costs, damages, and expenses, and reasonable attorney fees arising out of, directly or indirectly, any claim of personal injury or death associated with such unintended or unauthorized use, even if such claim alleges that **onsemi** was negligent regarding the design or manufacture of the part. **onsemi** is an Equal Opportunity/Affirmative Action Employer. This literature is subject to all applicable copyright laws and is not for resale in any manner.

## ADDITIONAL INFORMATION

### TECHNICAL PUBLICATIONS:

Technical Library: [www.onsemi.com/design/resources/technical-documentation](http://www.onsemi.com/design/resources/technical-documentation)  
onsemi Website: [www.onsemi.com](http://www.onsemi.com)

### ONLINE SUPPORT: [www.onsemi.com/support](http://www.onsemi.com/support)

For additional information, please contact your local Sales Representative at [www.onsemi.com/support/sales](http://www.onsemi.com/support/sales)