

# Comparator, High Speed, 50 ns, Low Voltage, Rail-to-Rail

## NCS2250, NCV2250, NCS2252, NCV2252

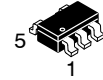

SCALE 2:1  
 TSOP-5  
 (SOT23-5)  
 CASE 483



SCALE 2:1  
 SC-88A  
 (SC70-5)  
 CASE 419A-02

The NCS2250 and NCS2252 low voltage comparators feature fast response time and rail-to-rail input and output. The extended common mode input voltage range allows input signals 200 mV above and below the rails, allowing voltage detection at ground or the supply. A propagation delay of 50 ns with a 100 mV overdrive makes this comparator suitable for applications requiring faster response times.

These single channel devices are available with a complementary push-pull output in the NCS2250 or with an open drain output in the NCS2252. Both options are offered in TSOP-5 (SOT23-5) and SC-88A (SC70-5) packages. Automotive qualified devices are also available, denoted by the NCV prefix.

### Features

- Propagation Delay: 50 ns with 100 mV Overdrive
- Rail-to-rail Input:  $V_{SS} - 200\text{ mV}$  to  $V_{DD} + 200\text{ mV}$
- Supply Voltage: 1.8 V to 5.5 V
- Supply Current: 150  $\mu\text{A}$  Typical at 5 V Supply
- Available with Push-pull or Open Drain Output
- Packages: TSOP-5 (SOT23-5) and SC-88A (SC70-5)
- NCV Prefix for Automotive and Other Applications Requiring Unique Site and Control Change Requirements; AEC-Q100 Qualified and PPAP Capable
- These Devices are Pb-free, Halogen Free/BFR Free and are RoHS Compliant

### Applications

- Voltage Threshold Detector
- Zero-crossing Detectors
- High-speed Sampling Circuits
- Logic Level Shifting / Translation
- Clock and Data Signal Restoration

### End Products

- Automotive
- Lighting
- Smartphones, cell phones
- Portable and battery-powered systems
- Power supplies

### MARKING DIAGRAMS

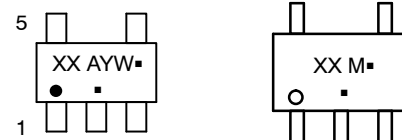

- XX = Specific Device Code
- A = Assembly Location
- Y = Year
- W = Work Week
- M = Date Code
- = Pb-Free Package

(Note: Microdot may be in either location)

### PIN DIAGRAM

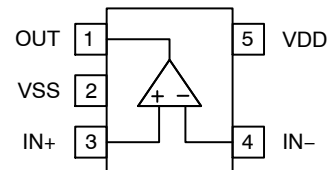

TSOP-5 (SOT23-5) and  
 SC-88A (SC70-5) pinout

### ORDERING INFORMATION

See detailed ordering and shipping information on page 2 of this data sheet.

# NCS2250, NCV2250, NCS2252, NCV2252

**Table 1. ORDERING INFORMATION**

| Automotive | Output     | Device (Note 1) | Package          | Marking | Shipping †         |
|------------|------------|-----------------|------------------|---------|--------------------|
| No         | Push-Pull  | NCS2250SQ2T2G   | SC-88A (SC70-5)  | 5C      | 3000 / Tape & Reel |
|            |            | NCS2250SN2T1G   | TSOP-5 (SOT23-5) | 5A      | 3000 / Tape & Reel |
|            | Open Drain | NCS2252SQ2T2G   | SC-88A (SC70-5)  | 5F      | 3000 / Tape & Reel |
|            |            | NCS2252SN2T1G   | TSOP-5 (SOT23-5) | 5D      | 3000 / Tape & Reel |
| Yes        | Push-Pull  | NCV2250SQ2T2G   | SC-88A (SC70-5)  | 5C      | 3000 / Tape & Reel |
|            |            | NCV2250SN2T1G   | TSOP-5 (SOT23-5) | 5A      | 3000 / Tape & Reel |
|            | Open Drain | NCV2252SQ2T2G   | SC-88A (SC70-5)  | 5F      | 3000 / Tape & Reel |
|            |            | NCV2252SN2T1G   | TSOP-5 (SOT23-5) | 5D      | 3000 / Tape & Reel |

†For information on tape and reel specifications, including part orientation and tape sizes, please refer to our Tape and Reel Packaging Specification Brochure, BRD8011/D.

1. Contact local sales office for more information.

**Table 2. PIN DESCRIPTION**

| Name            | Type   | Description   |
|-----------------|--------|---|
| V <sub>DD</sub> | Power  | Positive supply pin. Connect to positive rail. A bypass capacitor of at least 0.1 μF is recommended as close as possible to the V <sub>DD</sub> pin                                       |
| V <sub>SS</sub> | Power  | Negative supply pin. Connect to ground or negative rail. If not connected to ground, a bypass capacitor of at least 0.1 μF is recommended as close as possible to the V <sub>SS</sub> pin |
| OUT             | Output | Output pin. NCS2250 has a complementary push-pull output stage. NCS2252 has an open drain output stage which requires an external pull-up resistor  |
| IN-             | Input  | Inverting input   |
| IN+             | Input  | Non-inverting input   |

# NCS2250, NCV2250, NCS2252, NCV2252

**Table 3. ABSOLUTE MAXIMUM RATINGS** (Note 2)

| Rating                                     | Symbol       | Value                            | Units |
|--|--------------|----------------------------------|-------|
| Supply Voltage Range ( $V_{DD} - V_{SS}$ ) | $V_S$        | 0 to 6                           | V     |
| Input Voltage Range                        | $V_{IN}$     | $V_{SS} - 0.3$ to $V_{DD} + 0.3$ | V     |
| Output Voltage Range                       | $V_O$        | $V_{SS} - 0.3$ to $V_{DD} + 0.3$ | V     |
| Output Short Circuit Current (Note 3)      | $I_{SC}$     | Continuous                       | mA    |
| Maximum Junction Temperature (Note 4)      | $T_{J(max)}$ | +150                             | °C    |
| Storage Temperature Range                  | Tstg         | -65 to +150                      | °C    |
| ESD Capability (Note 5)                    |              |                                  | V     |
| Human Body Model                           | HBM          | 2000                             |       |
| Machine Model                              | MM           | 50                               |       |
| Latch-up Current (Note 6)                  | $I_{LU}$     | 100                              | mA    |
| Moisture Sensitivity Level (Note 7)        | MSL          | Level 1                          |       |

Stresses exceeding those listed in the Maximum Ratings table may damage the device. If any of these limits are exceeded, device functionality should not be assumed, damage may occur and reliability may be affected.

2. Refer to ELECTRICAL CHARACTERISTICS and APPLICATION INFORMATION for Safe Operating Area.
3. Applies to both single-supply and split-supply operation. Continuous short circuit operation at elevated ambient temperature can result in exceeding the maximum allowed junction temperature of 150°C. Output currents in excess of ±50 mA over long term may adversely affect reliability.
4. See APPLICATION INFORMATION for Safe Operating Area.
5. This device series incorporates ESD protection and is tested by the following methods:
  - ESD Human Body Model tested per JEDEC standard JESD22-A114 (AEC-Q100-002)
  - ESD Machine Model tested per JEDEC standard JESD22-A115 (AEC-Q100-003)
6. Latch-up Current per JEDEC standard JESD78.
7. Moisture Sensitivity Level tested per IPC/JEDEC standard J-ST-020A.

**Table 4. THERMAL INFORMATION**

| Parameter                                 | Symbol        | Package          | Single Layer Board<br>(Note 8) | Units |
|---|---------------|------------------|--------------------------------|-------|
| Junction-to-Ambient<br>Thermal Resistance | $\theta_{JA}$ | TSOP-5 (SOT23-5) | 150                            | °C/W  |
|   |               | SC-88A (SC70-5)  | 162                            |       |

8. Values based on a single layer 1S standard PCB with 1.0 oz copper and a 50 mm<sup>2</sup> copper area.

**Table 5. OPERATING RANGES** (Note 9)

| Parameter                       | Symbol   | Min            | Max            | Units |
|---------------------------------|----------|----------------|----------------|-------|
| Power Supply Voltage            | $V_S$    | 1.8            | 5.5            | V     |
| Input Common Mode Voltage Range | $V_{CM}$ | $V_{SS} - 0.2$ | $V_{DD} + 0.2$ | V     |
| Ambient Temperature             | $T_A$    | -40            | 125            | °C    |

9. See APPLICATION INFORMATION for Safe Operating Area.

# NCS2250, NCV2250, NCS2252, NCV2252

**Table 6. ELECTRICAL CHARACTERISTICS AT 5 V SUPPLY**

Typical values are referenced to  $T_A = 25^\circ\text{C}$ ,  $V_{DD} = 5\text{ V}$ ,  $V_{SS} = 0\text{ V}$ ,  $V_{CM} = \text{mid-supply}$ ,  $C_L = 50\text{ pF}$ , unless otherwise noted. NCS2252 is connected to  $R_{PULL-UP} = 10\text{ k}\Omega$  to  $V_{DD}$ , unless otherwise noted. Boldface numbers apply from  $T_A = -40^\circ\text{C}$  to  $125^\circ\text{C}$  (Notes 10, 11)

| Parameter                        | Test Conditions                               | Symbol             | Min                              | Typ             | Max                              | Units         |    |
|----------------------------------|---|--------------------|----------------------------------|-----------------|----------------------------------|---------------|----|
| <b>SUPPLY CHARACTERISTICS</b>    |   |                    |                                  |                 |                                  |               |    |
| Quiescent Supply Current         | No load                                       | $I_{DD}$           |                                  | 150             | 200                              | $\mu\text{A}$ |    |
|                                  |   |                    |                                  |                 | <b>250</b>                       |               |    |
| Power Supply Rejection Ratio     |   | PSRR               |                                  | 88              |                                  | dB            |    |
|                                  |   |                    | <b>62.5</b>                      |                 |                                  |               |    |
| <b>INPUT CHARACTERISTICS</b>     |   |                    |                                  |                 |                                  |               |    |
| Input Offset Voltage             |   | $V_{OS}$           |                                  | 0.5             | 6                                | mV            |    |
|                                  |   |                    |                                  |                 | <b>6</b>                         |               |    |
| Input Bias Current               | (Note 11)                                     | $I_{IB}$           |                                  | 20              |                                  | $\mu\text{A}$ |    |
|                                  |   |                    |                                  |                 | <b>1000</b>                      |               |    |
| Input Offset Current             | (Note 11)                                     | $I_{OS}$           |                                  | 20              |                                  | $\mu\text{A}$ |    |
|                                  |   |                    |                                  |                 | <b>1000</b>                      |               |    |
| Common Mode Rejection Ratio      |   | CMRR               |                                  | 81              |                                  | dB            |    |
|                                  |   |                    | <b>59</b>                        |                 |                                  |               |    |
| Input Capacitance                |   | $C_{IN}$           |                                  | 3.8             |                                  | pF            |    |
| <b>OUTPUT CHARACTERISTICS</b>    |   |                    |                                  |                 |                                  |               |    |
| Output Voltage High              | NCS2250, $I_{OUT} = 4\text{ mA}$              | $V_{OH}$           |                                  | $V_{DD} - 0.1$  |                                  | V             |    |
|                                  |   |                    | <b><math>V_{DD} - 0.3</math></b> |                 |                                  |               |    |
| Output Voltage Low               | $I_{OUT} = 4\text{ mA}$                       | $V_{OL}$           |                                  | $V_{SS} + 0.09$ |                                  | V             |    |
|                                  |   |                    |                                  |                 | <b><math>V_{SS} + 0.3</math></b> |               |    |
| Output Current Capability        | NCS2250, Sourcing                             | $I_O$              |                                  | 48              |                                  | mA            |    |
|                                  | Sinking                                       |                    |                                  | 52              |                                  |               |    |
| Output Leakage Current           | NCS2252, $V_S = 5.5\text{ V}$                 | $I_{LEAK}$         |                                  | 1               |                                  | nA            |    |
| Output Rise Time                 | NCS2250, 10% to 90%, $V_{OD} = 100\text{ mV}$ | $t_{rise}$         |                                  | 4               |                                  | ns            |    |
| Output Fall Time                 | NCS2250, 90% to 10%, $V_{OD} = 100\text{ mV}$ | $t_{fall}$         |                                  | 4               |                                  | ns            |    |
|                                  | NCS2252, 90% to 10%, $V_{OD} = 100\text{ mV}$ |                    |                                  | 5.5             |                                  |               |    |
| Propagation Delay (Note 11)      | NCS2250                                       | $t_{pLH}, t_{pHL}$ | $V_{OD} = 100\text{ mV}$         |                 | 50                               | 64            | ns |
|                                  |   |                    | $V_{OD} = 50\text{ mV}$          |                 | 60                               |               |    |
|                                  |   |                    | $V_{OD} = 20\text{ mV}$          |                 | 90                               |               |    |
|                                  | NCS2252 (Note 12)                             | $t_{pHL}$          | $V_{OD} = 100\text{ mV}$         |                 | 50                               | 64            | ns |
|                                  |   |                    | $V_{OD} = 50\text{ mV}$          |                 | 60                               |               |    |
|                                  |   |                    | $V_{OD} = 20\text{ mV}$          |                 | 90                               |               |    |
| Propagation Delay Skew (NCS2250) | $V_{OD} = 100\text{ mV}, C_L = 50\text{ pF}$  | $t_{SKEW}$         |                                  | 6               |                                  | ns            |    |
|                                  | $V_{OD} = 50\text{ mV}, C_L = 50\text{ pF}$   |                    |                                  | 2               |                                  |               |    |
|                                  | $V_{OD} = 20\text{ mV}, C_L = 50\text{ pF}$   |                    |                                  | 1               |                                  |               |    |

10. Refer to ABSOLUTE MAXIMUM RATINGS and APPLICATION INFORMATION for Safe Operating Area.

11. Performance guaranteed over the indicated operating temperature range by design and/or characterization.

12. Typical values are provided for NCS2252 output high-to-low propagation delay. NCS2252 is an open drain comparator. Output low-to-high propagation delay is a function of the RC time constant, which is dependent on the pull-up resistor.

# NCS2250, NCV2250, NCS2252, NCV2252

**Table 7. ELECTRICAL CHARACTERISTICS AT 1.8 V SUPPLY**

Typical values are referenced to  $T_A = 25^\circ\text{C}$ ,  $V_{DD} = 1.8\text{ V}$ ,  $V_{SS} = 0\text{ V}$ ,  $V_{CM} = \text{mid-supply}$ ,  $C_L = 50\text{ pF}$ , unless otherwise noted. NCS2252 is connected to  $R_{PULL-UP} = 10\text{ k}\Omega$  to  $V_{DD}$ , unless otherwise noted. Boldface numbers apply from  $T_A = -40^\circ\text{C}$  to  $125^\circ\text{C}$  (Notes 13, 14)

| Parameter                        | Test Conditions                               | Symbol             | Min                              | Typ             | Max                              | Units         |
|----------------------------------|---|--------------------|----------------------------------|-----------------|----------------------------------|---------------|
| <b>SUPPLY CHARACTERISTICS</b>    |   |                    |                                  |                 |                                  |               |
| Quiescent Supply Current         | No load                                       | $I_{DD}$           |                                  | 145             | 200                              | $\mu\text{A}$ |
|                                  |   |                    |                                  |                 | <b>250</b>                       |               |
| Power Supply Rejection Ratio     |   | PSRR               |                                  | 82              |                                  | dB            |
|                                  |   |                    | <b>62.5</b>                      |                 |                                  |               |
| <b>INPUT CHARACTERISTICS</b>     |   |                    |                                  |                 |                                  |               |
| Input Offset Voltage             |   | $V_{OS}$           |                                  | 0.5             | 6                                | mV            |
|                                  |   |                    |                                  |                 | <b>6</b>                         |               |
| Input Bias Current               | (Note 14)                                     | $I_{IB}$           |                                  | 20              |                                  | $\mu\text{A}$ |
|                                  |   |                    |                                  |                 | <b>1000</b>                      |               |
| Input Offset Current             | (Note 14)                                     | $I_{OS}$           |                                  | 20              |                                  | $\mu\text{A}$ |
|                                  |   |                    |                                  |                 | <b>1000</b>                      |               |
| Common Mode Rejection Ratio      |   | CMRR               |                                  | 76              |                                  | dB            |
|                                  |   |                    | <b>55</b>                        |                 |                                  |               |
| Input Capacitance                |   | $C_{IN}$           |                                  | 4.4             |                                  | pF            |
| <b>OUTPUT CHARACTERISTICS</b>    |   |                    |                                  |                 |                                  |               |
| Output Voltage High              | NCS2250, $I_{OUT} = 4\text{ mA}$              | $V_{OH}$           |                                  | $V_{DD} - 0.14$ |                                  | V             |
|                                  |   |                    | <b><math>V_{DD} - 0.3</math></b> |                 |                                  |               |
| Output Voltage Low               | $I_{OUT} = 4\text{ mA}$                       | $V_{OL}$           |                                  | $V_{SS} + 0.12$ |                                  | V             |
|                                  |   |                    |                                  |                 | <b><math>V_{SS} + 0.3</math></b> |               |
| Output Current Capability        | NCS2250, Sourcing                             | $I_O$              |                                  | 25              |                                  | mA            |
|                                  | Sinking                                       |                    |                                  | 42              |                                  |               |
| Output Leakage Current           | NCS2252, $V_S = 5.5\text{ V}$                 | $I_{LEAK}$         |                                  | 1               |                                  | nA            |
| Output Rise Time                 | NCS2250, 10% to 90%, $V_{OD} = 100\text{ mV}$ | $t_{rise}$         |                                  | 7               |                                  | ns            |
| Output Fall Time                 | NCS2250, 90% to 10%, $V_{OD} = 100\text{ mV}$ | $t_{fall}$         |                                  | 6               |                                  | ns            |
|                                  | NCS2252, 90% to 10%, $V_{OD} = 100\text{ mV}$ |                    |                                  | 7               |                                  |               |
| Propagation Delay (Note 14)      | NCS2250                                       | $t_{pLH}, t_{pHL}$ | $V_{OD} = 100\text{ mV}$         | 56              | 68                               | ns            |
|                                  |   |                    | $V_{OD} = 50\text{ mV}$          | 71              |                                  |               |
|                                  |   |                    | $V_{OD} = 20\text{ mV}$          | 106             |                                  |               |
|                                  | NCS2252 (Note 15)                             | $t_{pHL}$          | $V_{OD} = 100\text{ mV}$         | 56              | 68                               | ns            |
|                                  |   |                    | $V_{OD} = 50\text{ mV}$          | 71              |                                  |               |
|                                  |   |                    | $V_{OD} = 20\text{ mV}$          | 106             |                                  |               |
| Propagation Delay Skew (NCS2250) | $V_{OD} = 100\text{ mV}, C_L = 50\text{ pF}$  | $t_{SKEW}$         |                                  | 5               |                                  | ns            |
|                                  | $V_{OD} = 50\text{ mV}, C_L = 50\text{ pF}$   |                    |                                  | 2               |                                  |               |
|                                  | $V_{OD} = 20\text{ mV}, C_L = 50\text{ pF}$   |                    |                                  | 1               |                                  |               |

13. Refer to ABSOLUTE MAXIMUM RATINGS and APPLICATION INFORMATION for Safe Operating Area.

14. Performance guaranteed over the indicated operating temperature range by design and/or characterization.

15. Typical values are provided for NCS2252 output high-to-low propagation delay. NCS2252 is an open drain comparator.

Output low-to-high propagation delay is a function of the RC time constant, which is dependent on the pull-up resistor.

GRAPHS

Typical performance at  $T_A = 25^\circ\text{C}$ , unless otherwise noted.

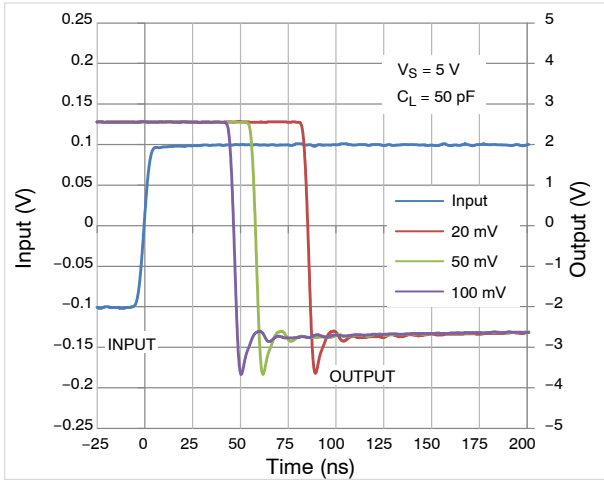

Figure 1. Transient Response at 5 V Supply with Varying Input Overdrive Voltages

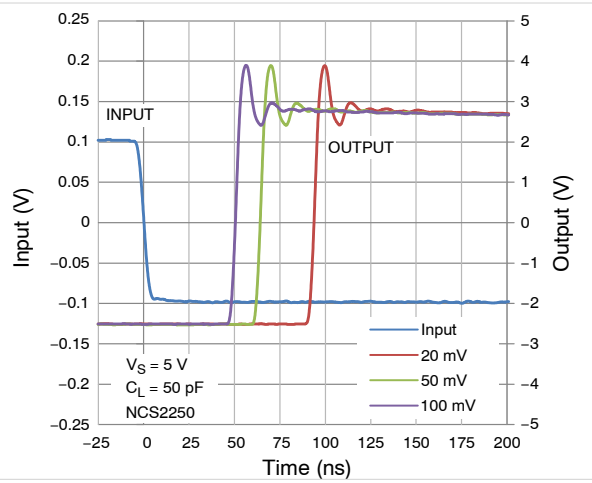

Figure 2. Transient Response at 5 V Supply with Varying Input Overdrive Voltages

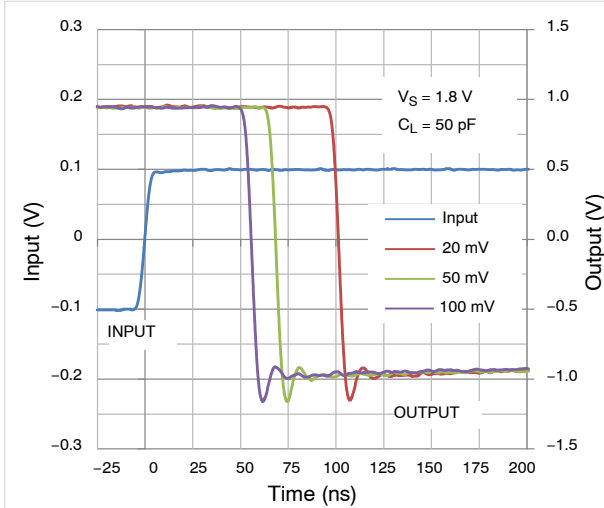

Figure 3. Transient Response at 1.8 V Supply with Varying Input Overdrive Voltages

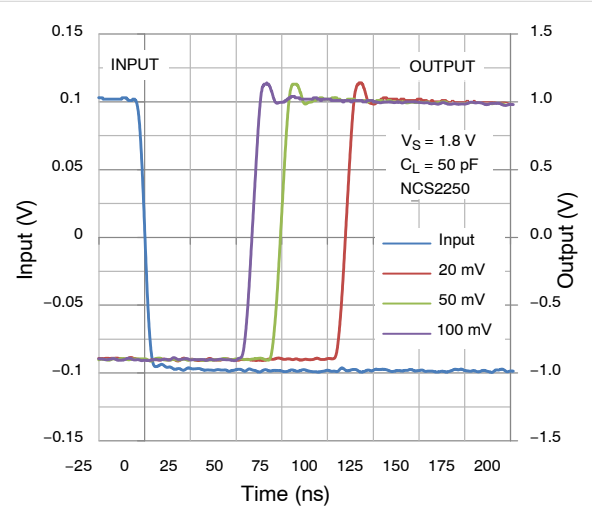

Figure 4. Transient Response at 1.8 V Supply with Varying Input Overdrive Voltages

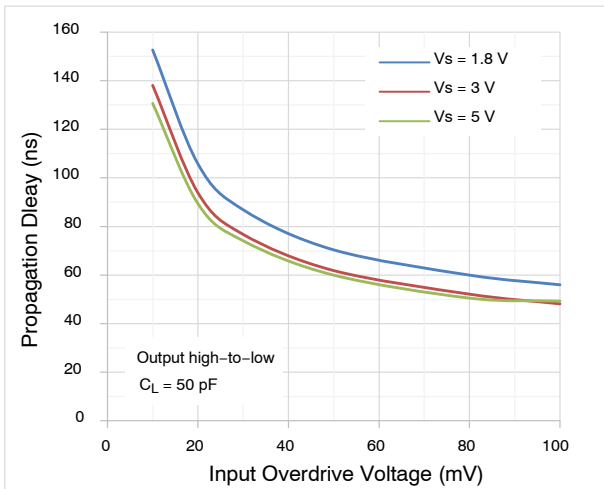

Figure 5. Output High-to-Low Propagation Delay vs. Input Overdrive Voltage

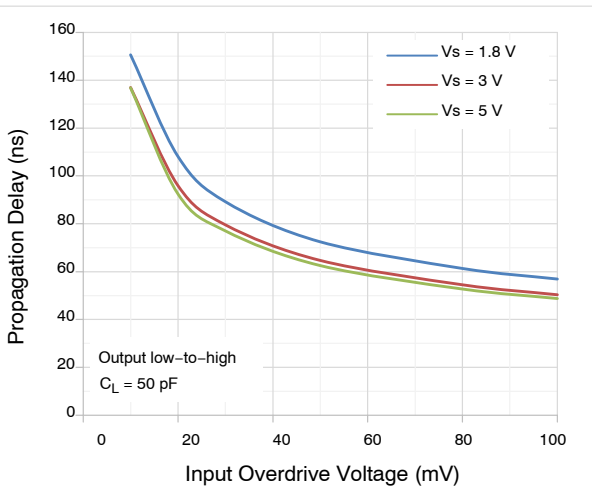
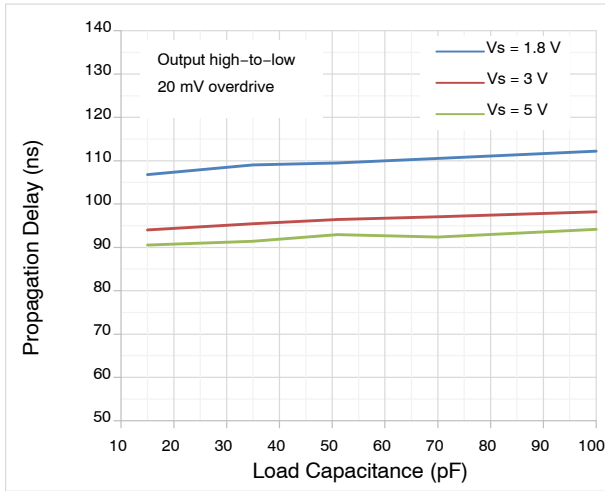

Figure 6. Output Low-to-High Propagation Delay vs. Input Overdrive Voltage

# NCS2250, NCV2250, NCS2252, NCV2252

## GRAPHS (continued)

Typical performance at  $T_A = 25^\circ\text{C}$ , unless otherwise noted.



**Figure 7. Output High-to-Low Propagation Delay vs. Load Capacitance**

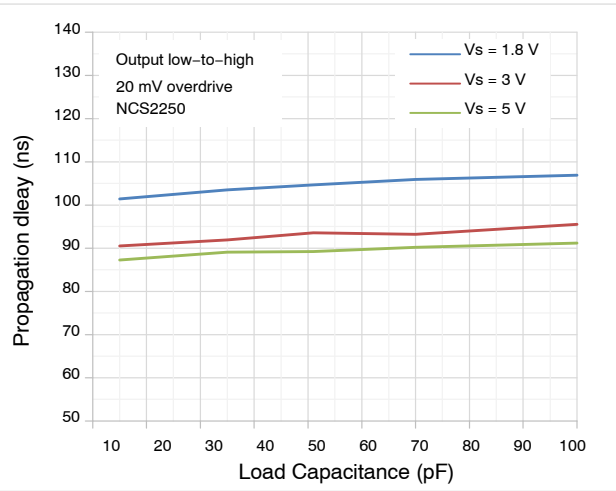

**Figure 8. Output Low-to-High Propagation Delay vs. Load Capacitance**

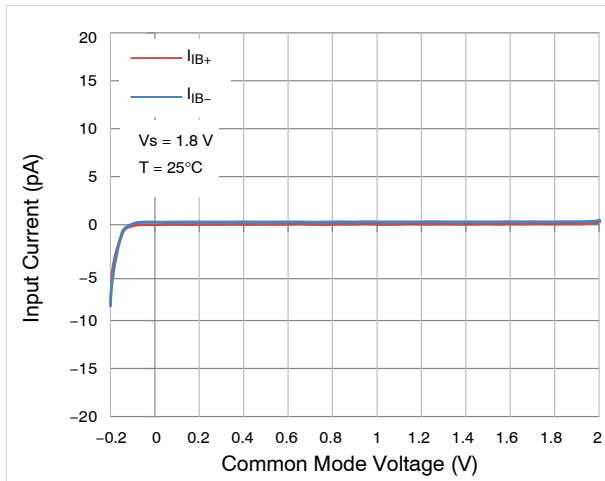

**Figure 9. Input Current vs. Common Mode Voltage at 1.8 V Supply**

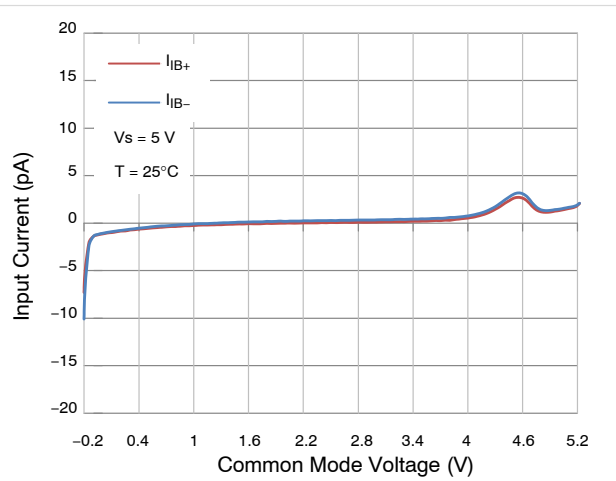

**Figure 10. Input Current vs. Common Mode Voltage at 5 V Supply**

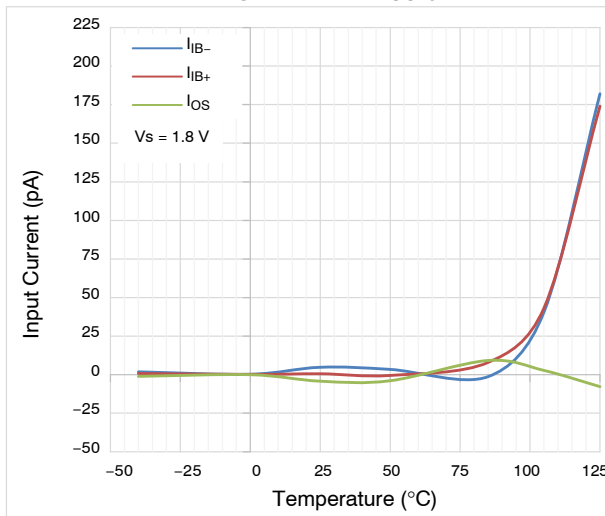

**Figure 11. Input Current vs. Temperature at 1.8 V Supply**

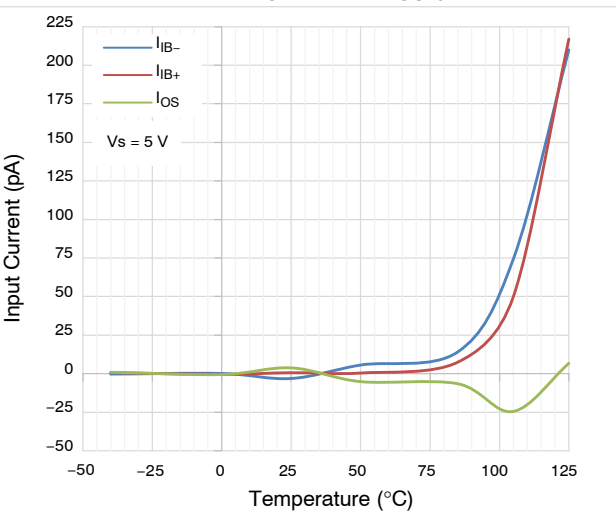
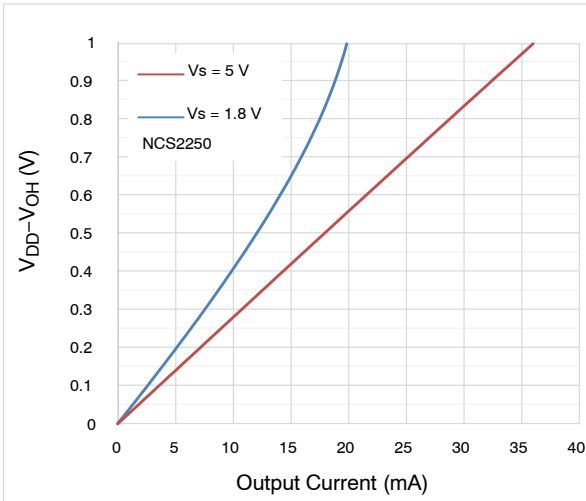

**Figure 12. Input Current vs. Temperature at 5 V Supply**

# NCS2250, NCV2250, NCS2252, NCV2252

## GRAPHS (continued)

Typical performance at  $T_A = 25^\circ\text{C}$ , unless otherwise noted.



**Figure 13. Output Voltage High (Relative to  $V_{DD}$ ) vs. Output Current**

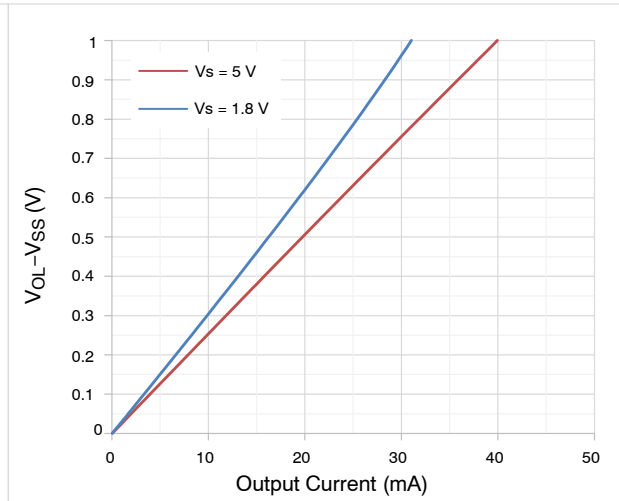

**Figure 14. Output Voltage Low (Relative to  $V_{SS}$ ) vs. Output Current**

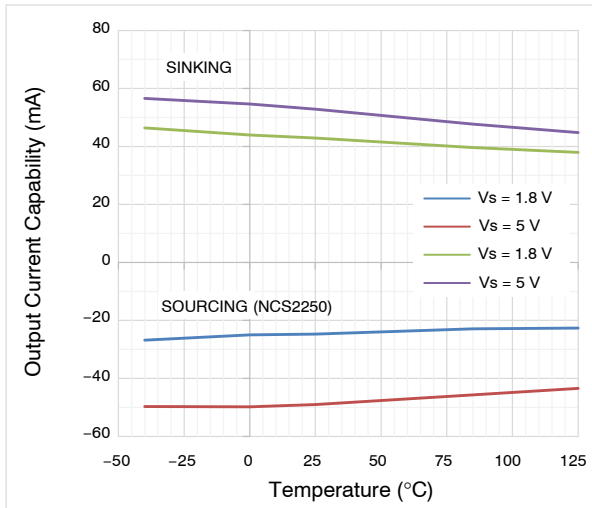

**Figure 15. Output Current Capability vs. Temperature**

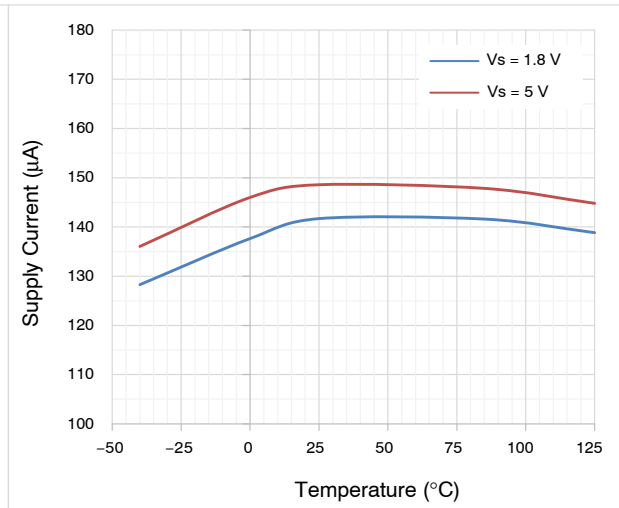

**Figure 16. Supply Current vs. Temperature**



**APPLICATION INFORMATION**

**Input Stage**

The NCS2250 and NCS2252 have rail-to-rail inputs. The input common mode voltage range of these comparators extend 200 mV beyond the rails, allowing voltage sensing at ground or at the supply voltage.

**Output Stage**

The NCS2250 has a complementary, push-pull output stage. When the output transitions between high and low states, a low resistance path is created between the positive and negative supply rails, temporarily increasing the supply current during the transition.

The NCS2252 has an open-drain output stage. This allows the output to be connected through a pull-up resistor to another supply voltage for applications where level translation or level shifting is needed. The output resistor can be connected to voltages below  $V_{DD}$  or up to  $V_{DD} + 0.3$  V. Since the NCS2252 relies on an external pull-up resistor

to provide sourcing current, the timing of the output low-to-high transition is determined by the RC time constant of the pull-up resistor and the load capacitance.

**Hysteresis**

When the inputs are near the same voltage, slight voltage fluctuations due to noise can cause the output to oscillate between high and low states. If noise-induced switching behavior is observed at the output, hysteresis should be added through an external resistor network. This is particularly the case for NCS2250, as sustained output oscillations causing increased supply current will result in elevated junction temperature.

Hysteresis can be added to the circuit by adding one or two external resistors depending on whether an inverting or non-inverting configuration is needed. Figure 17 shows the inverting configuration. In this configuration, the output voltage adjusts the threshold at the IN+ pin.

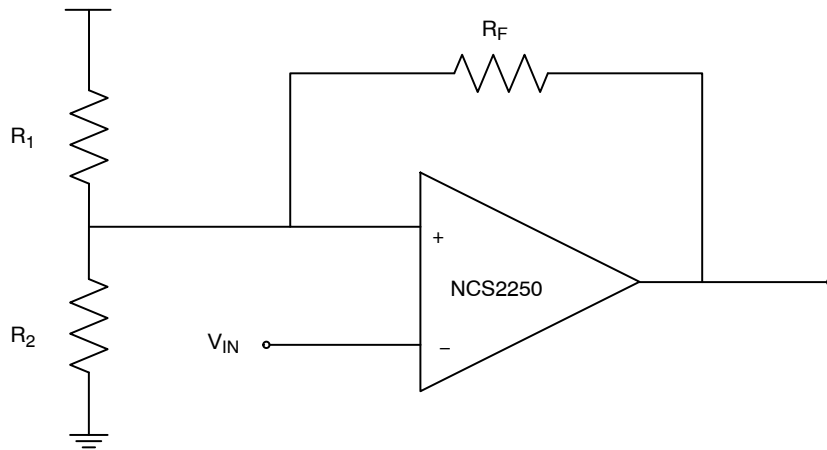

**Figure 17. Comparator with Hysteresis, Inverting Configuration**

For the inverting configuration, the value of the high-level input voltage which triggers the output to switch from high to low is given by the following equation:

$$V_{IN\_high} = \frac{R_2 \times R_F + R_1 \times R_2}{R_1 \times R_F + R_1 \times R_2 + R_2 \times R_F} \times V_{DD} \quad (\text{eq. 1})$$

The value of the low-level input voltage which triggers the output to switch from low to high is given by the following equation:

$$V_{IN\_low} = \frac{R_2 \times R_F}{R_1 \times R_F + R_1 \times R_2 + R_2 \times R_F} \times V_{DD} \quad (\text{eq. 2})$$

Figure 18 shows the non-inverting configuration. For the non-inverting configuration, the threshold  $V_{th}$  set by  $R_1$  and  $R_2$  is fixed. The output adjusts the input signal on IN+.

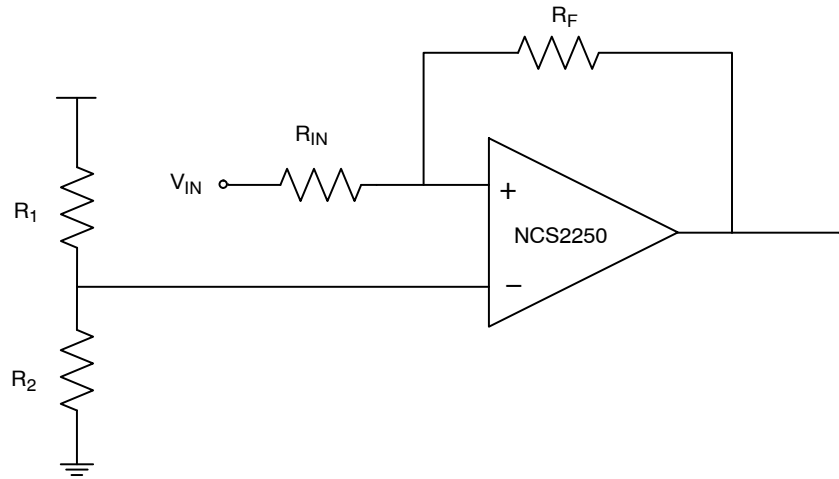

**Figure 18. Comparator with Hysteresis, Non-Inverting Configuration**

The value of the high-level input voltage which triggers the output to switch from low to high is given by the following equation:

$$V_{IN\_high} = \frac{V_{th} \times (R_{IN} + R_F)}{R_F} \quad (\text{eq. 3})$$

The value of the low-level input voltage which triggers the output to switch from high to low is given by the following equation:

$$V_{IN\_low} = \frac{V_{th} \times (R_{IN} + R_F) - R_{IN} \times V_{DD}}{R_F} \quad (\text{eq. 4})$$

**Power dissipation**

The absolute maximum junction temperature is 150°C. The junction temperature can be calculated using the power dissipation  $P$ , thermal resistance  $\theta_{JA}$ , and ambient temperature  $T_A$ .

$$T_J = \theta_{JA} \times P + T_A \quad (\text{eq. 5})$$

**Layout Techniques**

High speed layout techniques are recommended for the best performance.

Bypass capacitors of at least 0.1  $\mu$ F must be placed as close as possible to supply pins.

The traces on the input pins should be short to minimize any noise on the high impedance inputs. In general, shorter traces will reduce parasitic capacitance, inductance, and resistance.

Identify and keep sensitive traces away from possible noise sources such as clocks. Crosstalk can be reduced by increasing the distance between traces. Do not let traces run parallel for long distances. Take advantage of routing layers to separate traces that would otherwise run parallel. Ground or DC voltage supplies can be used to separate a sensitive trace from a noise source.

Avoid floating nodes as these will pick up noise.



SCALE 2:1

SC-88A (SC-70-5/SOT-353)  
CASE 419A-02  
ISSUE M

DATE 11 APR 2023

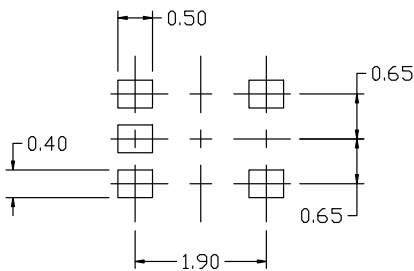
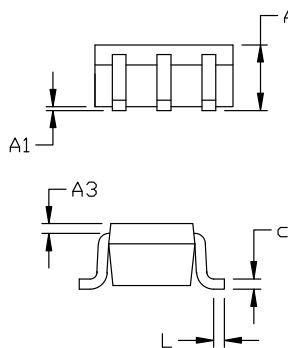

RECOMMENDED MOUNTING FOOTPRINT

\* For additional information on our Pb-Free strategy and soldering details, please download the ON Semiconductor Soldering and Mounting Techniques Reference Manual, SOLDERM/D.

NOTES:

1. DIMENSIONING AND TOLERANCING PER ANSI Y14.5M, 1982.
2. CONTROLLING DIMENSION: MILLIMETERS
3. 419A-01 OBSOLETE. NEW STANDARD 419A-02
4. DIMENSIONS D AND E1 DO NOT INCLUDE MOLD FLASH, PROTRUSIONS, OR GATE BURRS. MOLD FLASH, PROTRUSIONS, OR GATE BURRS SHALL NOT EXCEED 0.1016MM PER SIDE.

| DIM | MILLIMETERS |      |      |
|-----|-------------|------|------|
|     | MIN.        | NOM. | MAX. |
| A   | 0.80        | 0.95 | 1.10 |
| A1  | ---         | ---  | 0.10 |
| A3  | 0.20 REF    |      |      |
| b   | 0.10        | 0.20 | 0.30 |
| c   | 0.10        | ---  | 0.25 |
| D   | 1.80        | 2.00 | 2.20 |
| E   | 2.00        | 2.10 | 2.20 |
| E1  | 1.15        | 1.25 | 1.35 |
| e   | 0.65 BSC    |      |      |
| L   | 0.10        | 0.15 | 0.30 |

GENERIC MARKING DIAGRAM\*

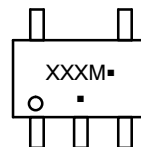

\*This information is generic. Please refer to device data sheet for actual part marking. Pb-Free indicator, "G" or microdot "▪", may or may not be present. Some products may not follow the Generic Marking.

XXX = Specific Device Code  
M = Date Code  
▪ = Pb-Free Package

(Note: Microdot may be in either location)

STYLE 1:

- PIN 1. BASE
- 2. EMITTER
- 3. BASE
- 4. COLLECTOR
- 5. COLLECTOR

STYLE 2:

- PIN 1. ANODE
- 2. EMITTER
- 3. BASE
- 4. COLLECTOR
- 5. CATHODE

STYLE 3:

- PIN 1. ANODE 1
- 2. N/C
- 3. ANODE 2
- 4. CATHODE 2
- 5. CATHODE 1

STYLE 4:

- PIN 1. SOURCE 1
- 2. DRAIN 1/2
- 3. SOURCE 1
- 4. GATE 1
- 5. GATE 2

STYLE 5:

- PIN 1. CATHODE
- 2. COMMON ANODE
- 3. CATHODE 2
- 4. CATHODE 3
- 5. CATHODE 4

STYLE 6:

- PIN 1. EMITTER 2
- 2. BASE 2
- 3. EMITTER 1
- 4. COLLECTOR
- 5. COLLECTOR 2/BASE 1

STYLE 7:

- PIN 1. BASE
- 2. EMITTER
- 3. BASE
- 4. COLLECTOR
- 5. COLLECTOR

STYLE 8:

- PIN 1. CATHODE
- 2. COLLECTOR
- 3. N/C
- 4. BASE
- 5. EMITTER

STYLE 9:

- PIN 1. ANODE
- 2. CATHODE
- 3. ANODE
- 4. ANODE
- 5. ANODE

Note: Please refer to datasheet for style callout. If style type is not called out in the datasheet refer to the device datasheet pinout or pin assignment.

|                  |                          |  |
|------------------|--------------------------|--|
| DOCUMENT NUMBER: | 98ASB42984B              | Electronic versions are uncontrolled except when accessed directly from the Document Repository. Printed versions are uncontrolled except when stamped "CONTROLLED COPY" in red. |
| DESCRIPTION:     | SC-88A (SC-70-5/SOT-353) | PAGE 1 OF 1  |

onsemi and onsemi are trademarks of Semiconductor Components Industries, LLC dba onsemi or its subsidiaries in the United States and/or other countries. onsemi reserves the right to make changes without further notice to any products herein. onsemi makes no warranty, representation or guarantee regarding the suitability of its products for any particular purpose, nor does onsemi assume any liability arising out of the application or use of any product or circuit, and specifically disclaims any and all liability, including without limitation special, consequential or incidental damages. onsemi does not convey any license under its patent rights nor the rights of others.

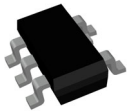

TSOP-5 3.00x1.50x0.95, 0.95P  
CASE 483  
ISSUE P

DATE 01 APR 2024

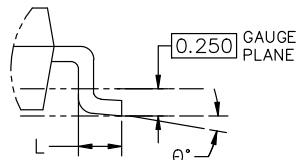
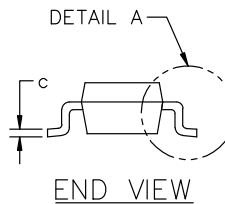
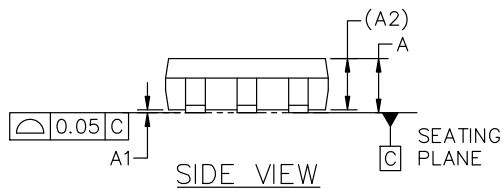
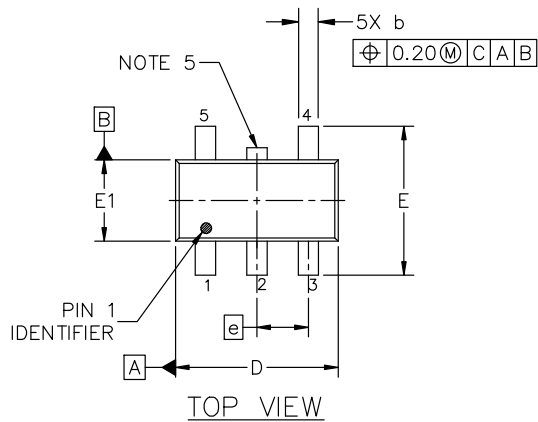

DETAIL "A"  
SCALE 2:1

GENERIC  
MARKING DIAGRAM\*

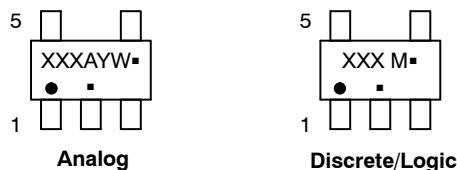

- XXX = Specific Device Code
- A = Assembly Location
- Y = Year
- W = Work Week
- = Pb-Free Package

(Note: Microdot may be in either location)

\*This information is generic. Please refer to device data sheet for actual part marking. Pb-Free indicator, "G" or microdot "▪", may or may not be present. Some products may not follow the Generic Marking.

NOTES:

1. DIMENSIONING AND TOLERANCING CONFORM TO ASME Y14.5-2018.
2. ALL DIMENSION ARE IN MILLIMETERS (ANGLES IN DEGREES).
3. MAXIMUM LEAD THICKNESS INCLUDES LEAD FINISH THICKNESS. MINIMUM LEAD THICKNESS IS THE MINIMUM THICKNESS OF BASE MATERIAL.
4. DIMENSIONS D AND E1 DO NOT INCLUDE MOLD FLASH, PROTRUSIONS OF GATE BURRS. MOLD FLASH, PROTRUSIONS, OR GATE BURRS SHALL NOT EXCEED 0.15 PER SIDE. DIMENSION D.
5. OPTIONAL CONSTRUCTION: AN ADDITIONAL TRIMMED LEAD IS ALLOWED IN THIS LOCATION. TRIMMED LEAD NOT TO EXTEND MORE THAN 0.2 FROM BODY.

| DIM | MILLIMETERS |       |       |
|-----|-------------|-------|-------|
|     | MIN.        | NOM.  | MAX.  |
| A   | 0.900       | 1.000 | 1.100 |
| A1  | 0.010       | 0.055 | 0.100 |
| A2  | 0.950 REF.  |       |       |
| b   | 0.250       | 0.375 | 0.500 |
| c   | 0.100       | 0.180 | 0.260 |
| D   | 2.850       | 3.000 | 3.150 |
| E   | 2.500       | 2.750 | 3.000 |
| E1  | 1.350       | 1.500 | 1.650 |
| e   | 0.950 BSC   |       |       |
| L   | 0.200       | 0.400 | 0.600 |
| θ   | 0°          | 5°    | 10°   |

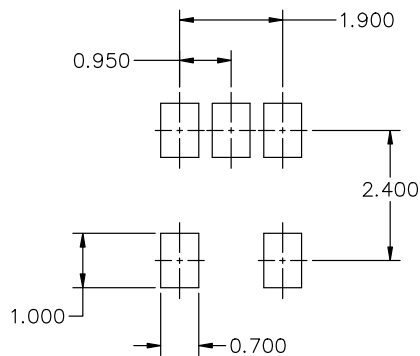

RECOMMENDED MOUNTING FOOTPRINT\*

\* FOR ADDITIONAL INFORMATION ON OUR Pb-FREE STRATEGY AND SOLDERING DETAILS, PLEASE DOWNLOAD THE ON SEMICONDUCTOR SOLDERING AND MOUNTING TECHNIQUES REFERENCE MANUAL, SOLDERM/D.

|                  |                              |  |
|------------------|------------------------------|--|
| DOCUMENT NUMBER: | 98ARB18753C                  | Electronic versions are uncontrolled except when accessed directly from the Document Repository. Printed versions are uncontrolled except when stamped "CONTROLLED COPY" in red. |
| DESCRIPTION:     | TSOP-5 3.00x1.50x0.95, 0.95P | PAGE 1 OF 1  |

onsemi and onsemi are trademarks of Semiconductor Components Industries, LLC dba onsemi or its subsidiaries in the United States and/or other countries. onsemi reserves the right to make changes without further notice to any products herein. onsemi makes no warranty, representation or guarantee regarding the suitability of its products for any particular purpose, nor does onsemi assume any liability arising out of the application or use of any product or circuit, and specifically disclaims any and all liability, including without limitation special, consequential or incidental damages. onsemi does not convey any license under its patent rights nor the rights of others.

**onsemi**, **Onsemi**, and other names, marks, and brands are registered and/or common law trademarks of Semiconductor Components Industries, LLC dba "**onsemi**" or its affiliates and/or subsidiaries in the United States and/or other countries. **onsemi** owns the rights to a number of patents, trademarks, copyrights, trade secrets, and other intellectual property. A listing of **onsemi**'s product/patent coverage may be accessed at [www.onsemi.com/site/pdf/Patent-Marking.pdf](http://www.onsemi.com/site/pdf/Patent-Marking.pdf). **onsemi** reserves the right to make changes at any time to any products or information herein, without notice. The information herein is provided "as-is" and **onsemi** makes no warranty, representation or guarantee regarding the accuracy of the information, product features, availability, functionality, or suitability of its products for any particular purpose, nor does **onsemi** assume any liability arising out of the application or use of any product or circuit, and specifically disclaims any and all liability, including without limitation special, consequential or incidental damages. Buyer is responsible for its products and applications using **onsemi** products, including compliance with all laws, regulations and safety requirements or standards, regardless of any support or applications information provided by **onsemi**. "Typical" parameters which may be provided in **onsemi** data sheets and/or specifications can and do vary in different applications and actual performance may vary over time. All operating parameters, including "Typicals" must be validated for each customer application by customer's technical experts. **onsemi** does not convey any license under any of its intellectual property rights nor the rights of others. **onsemi** products are not designed, intended, or authorized for use as a critical component in life support systems or any FDA Class 3 medical devices or medical devices with a same or similar classification in a foreign jurisdiction or any devices intended for implantation in the human body. Should Buyer purchase or use **onsemi** products for any such unintended or unauthorized application, Buyer shall indemnify and hold **onsemi** and its officers, employees, subsidiaries, affiliates, and distributors harmless against all claims, costs, damages, and expenses, and reasonable attorney fees arising out of, directly or indirectly, any claim of personal injury or death associated with such unintended or unauthorized use, even if such claim alleges that **onsemi** was negligent regarding the design or manufacture of the part. **onsemi** is an Equal Opportunity/Affirmative Action Employer. This literature is subject to all applicable copyright laws and is not for resale in any manner.

## ADDITIONAL INFORMATION

### TECHNICAL PUBLICATIONS:

Technical Library: [www.onsemi.com/design/resources/technical-documentation](http://www.onsemi.com/design/resources/technical-documentation)  
onsemi Website: [www.onsemi.com](http://www.onsemi.com)

### ONLINE SUPPORT: [www.onsemi.com/support](http://www.onsemi.com/support)

For additional information, please contact your local Sales Representative at [www.onsemi.com/support/sales](http://www.onsemi.com/support/sales)