

# ON Semiconductor

## Is Now

# onsemi™

To learn more about onsemi™, please visit our website at  
[www.onsemi.com](http://www.onsemi.com)

---

**onsemi** and **onsemi** and other names, marks, and brands are registered and/or common law trademarks of Semiconductor Components Industries, LLC dba "**onsemi**" or its affiliates and/or subsidiaries in the United States and/or other countries. **onsemi** owns the rights to a number of patents, trademarks, copyrights, trade secrets, and other intellectual property. A listing of **onsemi** product/patent coverage may be accessed at [www.onsemi.com/site/pdf/Patent-Marking.pdf](http://www.onsemi.com/site/pdf/Patent-Marking.pdf). **onsemi** reserves the right to make changes at any time to any products or information herein, without notice. The information herein is provided "as-is" and **onsemi** makes no warranty, representation or guarantee regarding the accuracy of the information, product features, availability, functionality, or suitability of its products for any particular purpose, nor does **onsemi** assume any liability arising out of the application or use of any product or circuit, and specifically disclaims any and all liability, including without limitation special, consequential or incidental damages. Buyer is responsible for its products and applications using **onsemi** products, including compliance with all laws, regulations and safety requirements or standards, regardless of any support or applications information provided by **onsemi**. "Typical" parameters which may be provided in **onsemi** data sheets and/or specifications can and do vary in different applications and actual performance may vary over time. All operating parameters, including "Typicals" must be validated for each customer application by customer's technical experts. **onsemi** does not convey any license under any of its intellectual property rights nor the rights of others. **onsemi** products are not designed, intended, or authorized for use as a critical component in life support systems or any FDA Class 3 medical devices or medical devices with a same or similar classification in a foreign jurisdiction or any devices intended for implantation in the human body. Should Buyer purchase or use **onsemi** products for any such unintended or unauthorized application, Buyer shall indemnify and hold **onsemi** and its officers, employees, subsidiaries, affiliates, and distributors harmless against all claims, costs, damages, and expenses, and reasonable attorney fees arising out of, directly or indirectly, any claim of personal injury or death associated with such unintended or unauthorized use, even if such claim alleges that **onsemi** was negligent regarding the design or manufacture of the part. **onsemi** is an Equal Opportunity/Affirmative Action Employer. This literature is subject to all applicable copyright laws and is not for resale in any manner. Other names and brands may be claimed as the property of others.

# MMDJ3P03BJT

## Plastic Power Transistors SO-8 for Surface Mount Applications

- Collector -Emitter Sustaining Voltage —  
 $V_{CE(sus)} = 30 \text{ Vdc (Min) @ } I_C = 10 \text{ mAdc}$
- High DC Current Gain —  
 $h_{FE} = 125 \text{ (Min) @ } I_C = 0.8 \text{ Adc}$   
 $= 90 \text{ (Min) @ } I_C = 3.0 \text{ Adc}$
- Low Collector -Emitter Saturation Voltage —  
 $V_{CE(sat)} = 0.24 \text{ Vdc (Max) @ } I_C = 1.2 \text{ Adc}$   
 $= 0.55 \text{ Vdc (Max) @ } I_C = 3.0 \text{ Adc}$
- Miniature SO-8 Surface Mount Package – Saves Board Space



**ON Semiconductor®**

<http://onsemi.com>

**DUAL BIPOLAR  
POWER TRANSISTOR  
PNP SILICON  
30 VOLTS, 3 AMPERES**

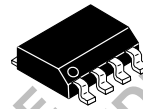

(SO-8)  
CASE 751-07  
Style 16

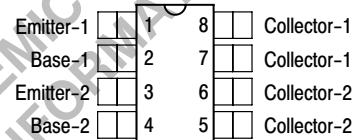

Top View  
Pinout

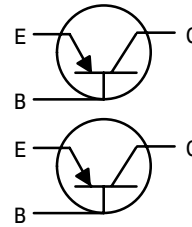

Schematic

Preferred devices are ON Semiconductor recommended choices for future use and best overall value.

# MMDJ3P03BJT

## MAXIMUM RATINGS ( $T_C = 25^\circ\text{C}$ unless otherwise noted)

Rating	Symbol	Value	Unit
Collector-Base Voltage	$V_{CB}$	45	Vdc
Collector-Emitter Voltage	$V_{CEO}$	30	Vdc
Emitter-Base Voltage	$V_{EB}$	$\pm 6.0$	Vdc
Collector Current — Continuous — Peak	$I_C$	3.0 5.0	Adc
Base Current — Continuous	$I_B$	1.0	Adc
Operating and Storage Junction Temperature Range	$T_J, T_{stg}$	-55 to +150	$^\circ\text{C}$

## THERMAL CHARACTERISTICS

Characteristic	Symbol	Max	Unit
Thermal Resistance - Junction to Ambient on 1" sq. (645 sq. mm) Collector pad on FR-4 board material with one die operating.	$R_{\theta JA}$	100	$^\circ\text{C}/\text{W}$
Thermal Resistance - Junction to Ambient on 0.012" sq. (7.6 sq. mm) Collector pad on FR-4 board material with one die operating.		185	
Total Power Dissipation @ $T_A = 25^\circ\text{C}$ mounted on 1" sq. (645 sq. mm) Collector pad on FR-4 board material with one die operating. Derate above $25^\circ\text{C}$	$P_D$	1.25 10	Watts $\text{mW}/^\circ\text{C}$
Maximum Temperature for Soldering	$T_L$	260	$^\circ\text{C}$

**OBSOLETE**  
THIS DEVICE IS OBSOLETE  
PLEASE CONTACT YOUR ON SEMI  
REPRESENTATIVE FOR INFORMATION

# MMDJ3P03BJT

## ELECTRICAL CHARACTERISTICS (T<sub>C</sub> = 25°C unless otherwise noted)

Characteristic	Symbol	Min	Typ	Max	Unit
----------------	--------	-----	-----	-----	------

### OFF CHARACTERISTICS

Collector-Emitter Sustaining Voltage (I <sub>C</sub> = 10 mA, I <sub>B</sub> = 0 A)	V <sub>CEO(sus)</sub>	30	—	—	Vdc
Emitter-Base Voltage (I <sub>E</sub> = 50 μA, I <sub>C</sub> = 0 A)	V <sub>EBO</sub>	6.0	—	—	Vdc
Collector Cutoff Current (V <sub>CE</sub> = 25 Vdc, R <sub>BE</sub> = 200 Ω) (V <sub>CE</sub> = 25 Vdc, R <sub>BE</sub> = 200 Ω, T <sub>J</sub> = 125°C)	I <sub>CER</sub>	— —	— —	20 200	μA
Emitter Cutoff Current (V <sub>BE</sub> = 5.0 Vdc)	I <sub>EBO</sub>	—	—	10	μA

### ON CHARACTERISTICS<sup>(1)</sup>

Collector-Emitter Saturation Voltage (I <sub>C</sub> = 0.8 A, I <sub>B</sub> = 20 mA) (I <sub>C</sub> = 1.2 A, I <sub>B</sub> = 20 mA) (I <sub>C</sub> = 3.0 A, I <sub>B</sub> = 0.3 A)	V <sub>CE(sat)</sub>	— — —	0.15 — —	0.21 0.24 0.55	Vdc
Base-Emitter Saturation Voltage (I <sub>C</sub> = 3.0 A, I <sub>B</sub> = 0.3 A)	V <sub>BE(sat)</sub>	—	—	1.25	Vdc
Base-Emitter On Voltage (I <sub>C</sub> = 1.2 A, V <sub>CE</sub> = 4.0 Vdc)	V <sub>BE(on)</sub>	—	—	1.10	Vdc
DC Current Gain (I <sub>C</sub> = 0.8 A, V <sub>CE</sub> = 1.0 Vdc) (I <sub>C</sub> = 1.2 A, V <sub>CE</sub> = 1.0 Vdc) (I <sub>C</sub> = 3.0 A, V <sub>CE</sub> = 1.0 Vdc)	h <sub>FE</sub>	125 110 90	260 — —	— — —	—

### DYNAMIC CHARACTERISTICS

Output Capacitance (V <sub>CB</sub> = 10 Vdc, I <sub>E</sub> = 0 A, f = 1.0 MHz)	C <sub>ob</sub>	—	100	150	pF
Input Capacitance (V <sub>EB</sub> = 8.0 Vdc)	C <sub>ib</sub>	—	135	—	pF
Current-Gain — Bandwidth Product <sup>(2)</sup> (I <sub>C</sub> = 500 mA, V <sub>CE</sub> = 10 V, F <sub>test</sub> = 1.0 MHz)	f <sub>T</sub>	—	110	—	MHz

(1) Pulse Test: Pulse Width ≤ 300 μs, Duty Cycle ≤ 2%.

(2) f<sub>T</sub> = |h<sub>FE</sub>| • f<sub>test</sub>

PLEASE CONTACT  
REPRESENTATIVE

# MMDJ3P03BJT

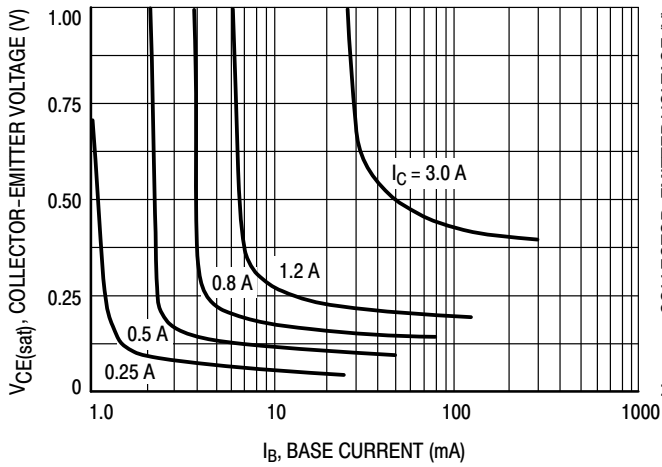

Figure 1. Collector Saturation Region

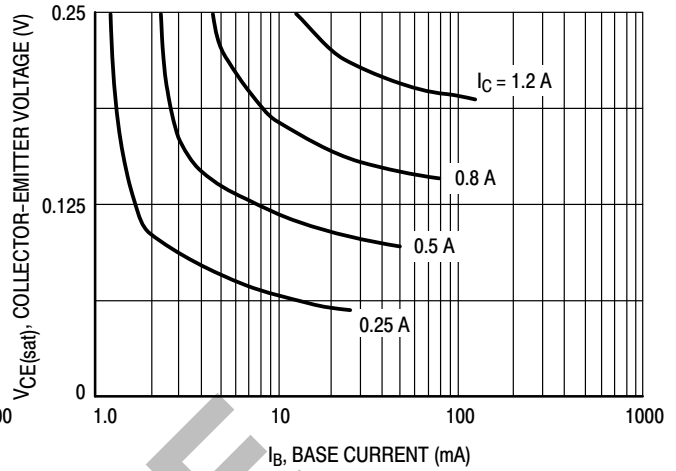

Figure 2. Collector Saturation Region

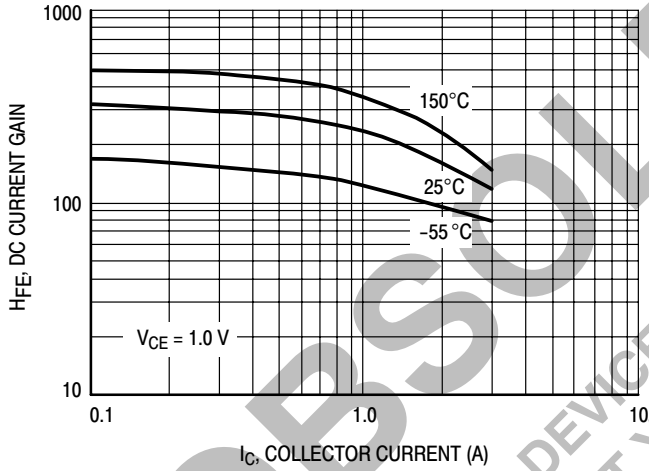

Figure 3. DC Current Gain

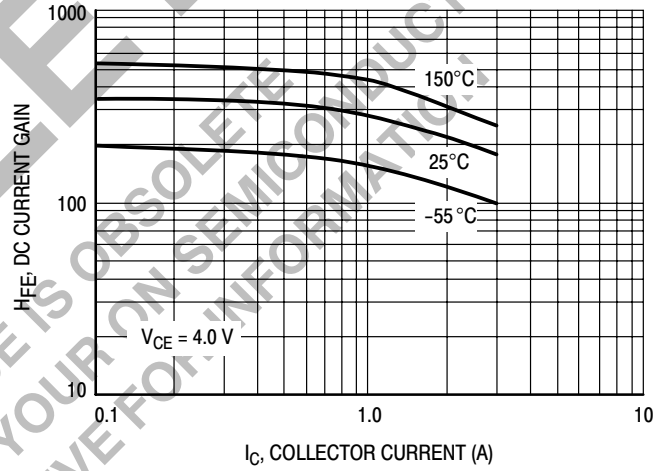

Figure 4. DC Current Gain

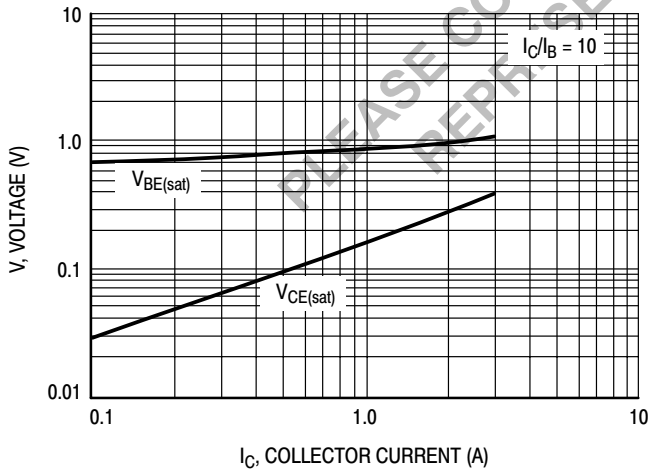

Figure 5. "On" Voltages

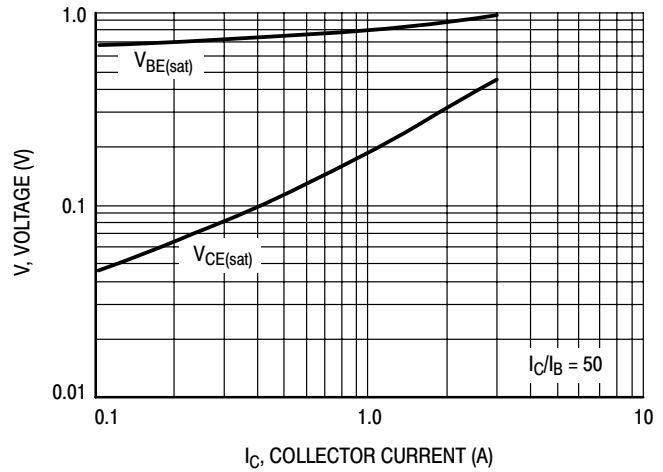

Figure 6. "On" Voltages

# MMDJ3P03BJT

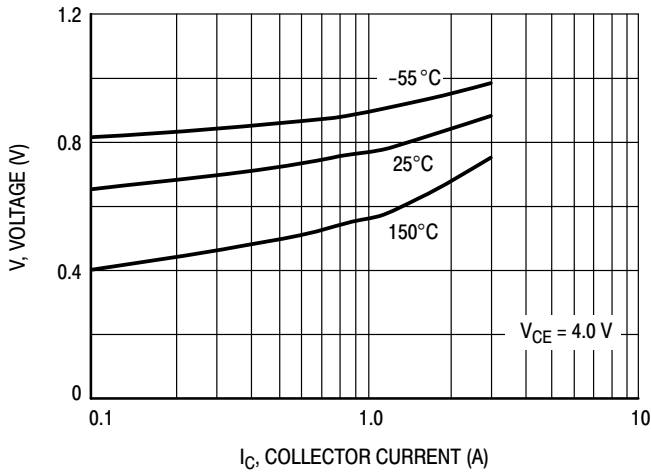

Figure 7.  $V_{BE(on)}$  Voltage

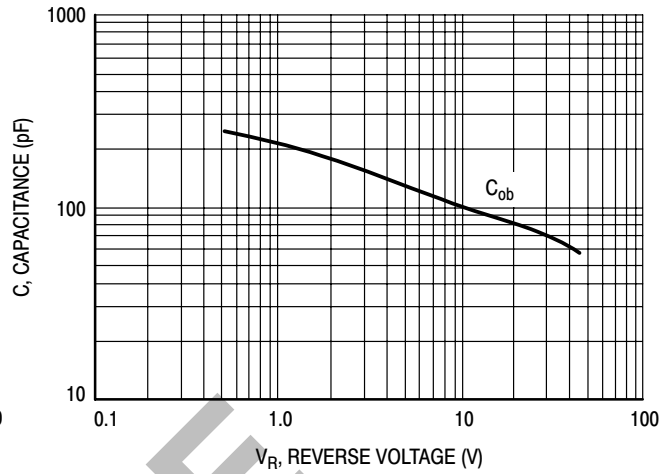

Figure 8. Output Capacitance

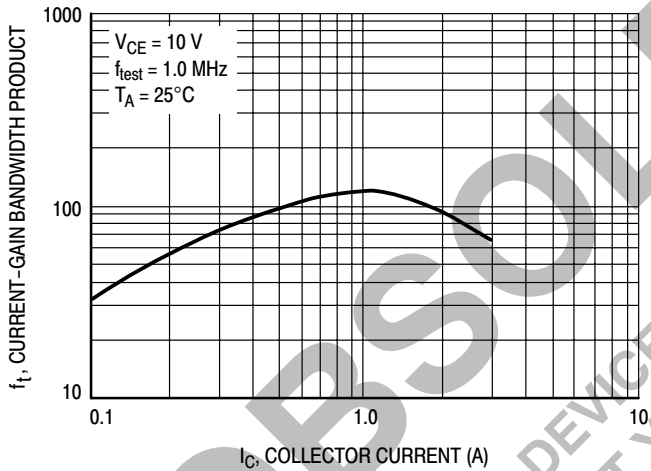

Figure 9. Current-Gain Bandwidth Product

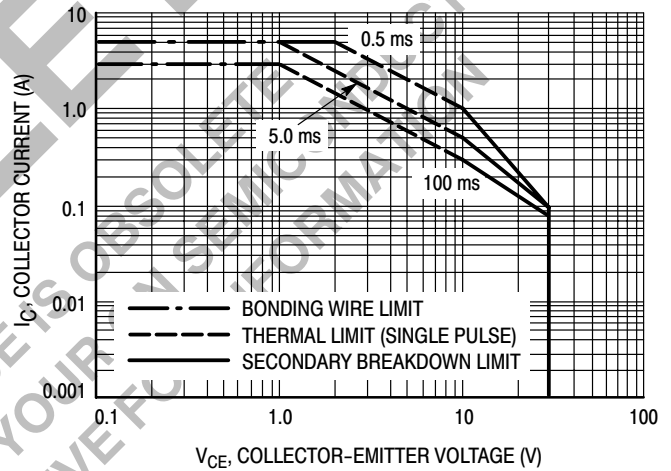

Figure 10. Active Region Safe Operating Area

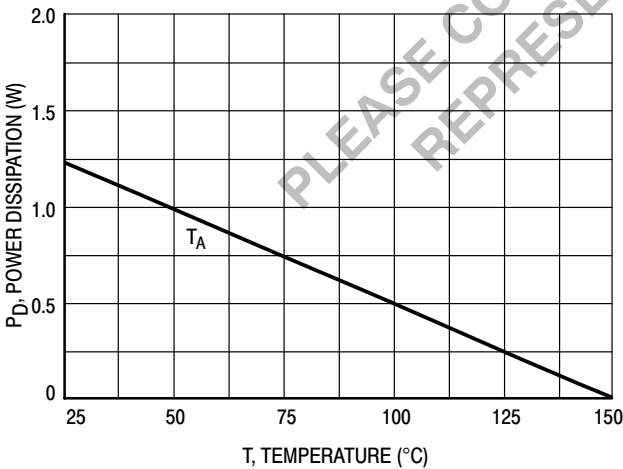

Figure 11. Power Derating

There are two limitations on the power handling ability of a transistor: average junction temperature and secondary breakdown. Safe operating area curves indicate  $I_C - V_{CE}$  limits of the transistor that must be observed for reliable operation; i.e., the transistor must not be subjected to greater dissipation than the curves indicate.

The data of Figure 10 is based on  $T_{J(pk)} = 150^\circ\text{C}$ ;  $T_C$  is variable depending on conditions. Secondary breakdown pulse limits are valid for duty cycles to 10% provided  $T_{J(pk)} \leq 150^\circ\text{C}$ .  $T_{J(pk)}$  may be calculated from the data in Figure 12. At high case temperatures, thermal limitations will reduce the power that can be handled to values less than the limitations imposed by secondary breakdown.

MMDJ3P03BJT

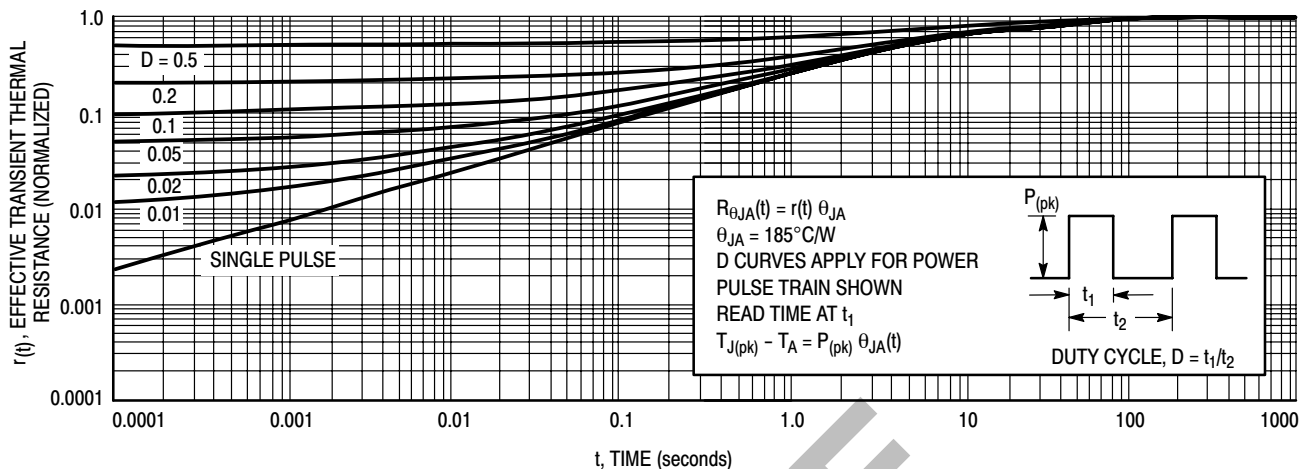

Figure 12. Thermal Response

OBSOLETE

THIS DEVICE IS OBSOLETE  
PLEASE CONTACT YOUR ON SEMICONDUCTOR  
REPRESENTATIVE FOR INFORMATION

# MMDJ3P03BJT

## PACKAGE DIMENSIONS

SOIC-8 NB  
CASE 751-07  
ISSUE W

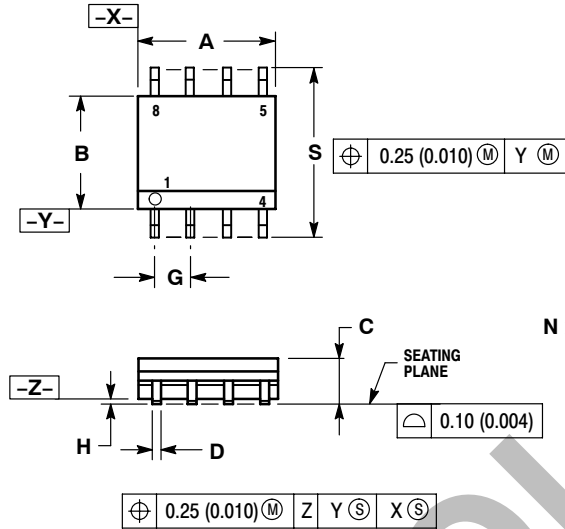

### NOTES:

- DIMENSIONING AND TOLERANCING PER ANSI Y14.5M, 1982.
- CONTROLLING DIMENSION: MILLIMETER.
- DIMENSION A AND B DO NOT INCLUDE MOLD PROTRUSION.
- MAXIMUM MOLD PROTRUSION 0.15 (0.006) PER SIDE.
- DIMENSION D DOES NOT INCLUDE DAMBAR PROTRUSION. ALLOWABLE DAMBAR PROTRUSION SHALL BE 0.127 (0.005) TOTAL IN EXCESS OF THE D DIMENSION AT MAXIMUM MATERIAL CONDITION.

DIM	MILLIMETERS		INCHES	
	MIN	MAX	MIN	MAX
A	4.80	5.00	0.189	0.197
B	3.80	4.00	0.150	0.157
C	1.35	1.75	0.053	0.069
D	0.33	0.51	0.013	0.020
G	1.27 BSC		0.050 BSC	
H	0.10	0.25	0.004	0.010
J	0.19	0.25	0.007	0.010
K	0.40	1.27	0.016	0.050
M	0°	8°	0°	8°
N	0.25	0.50	0.010	0.020
S	5.80	6.20	0.228	0.244

### STYLE 16:

- PIN 1: EMITTER, DIE #1
- BASE, DIE #1
- EMITTER, DIE #2
- BASE, DIE #2
- COLLECTOR, DIE #2
- COLLECTOR, DIE #2
- COLLECTOR, DIE #1
- COLLECTOR, DIE #1

ON Semiconductor and are registered trademarks of Semiconductor Components Industries, LLC (SCILLC). SCILLC reserves the right to make changes without further notice to any products herein. SCILLC makes no warranty, representation or guarantee regarding the suitability of its products for any particular purpose, nor does SCILLC assume any liability arising out of the application or use of any product or circuit, and specifically disclaims any and all liability, including without limitation special, consequential or incidental damages. "Typical" parameters which may be provided in SCILLC data sheets and/or specifications can and do vary in different applications and actual performance may vary over time. All operating parameters, including "Typicals" must be validated for each customer application by customer's technical experts. SCILLC does not convey any license under its patent rights nor the rights of others. SCILLC products are not designed, intended, or authorized for use as components in systems intended for surgical implant into the body, or other applications intended to support or sustain life, or for any other application in which the failure of the SCILLC product could create a situation where personal injury or death may occur. Should Buyer purchase or use SCILLC products for any such unintended or unauthorized application, Buyer shall indemnify and hold SCILLC and its officers, employees, subsidiaries, affiliates, and distributors harmless against all claims, costs, damages, and expenses, and reasonable attorney fees arising out of, directly or indirectly, any claim of personal injury or death associated with such unintended or unauthorized use, even if such claim alleges that SCILLC was negligent regarding the design or manufacture of the part. SCILLC is an Equal Opportunity/Affirmative Action Employer. This literature is subject to all applicable copyright laws and is not for resale in any manner.

### PUBLICATION ORDERING INFORMATION

**LITERATURE FULFILLMENT:**  
Literature Distribution Center for ON Semiconductor  
P.O. Box 5163, Denver, Colorado 80217 USA  
**Phone:** 303-675-2175 or 800-344-3860 Toll Free USA/Canada  
**Fax:** 303-675-2176 or 800-344-3867 Toll Free USA/Canada  
**Email:** orderlit@onsemi.com

**N. American Technical Support:** 800-282-9855 Toll Free USA/Canada  
**Europe, Middle East and Africa Technical Support:**  
Phone: 421 33 790 2910  
**Japan Customer Focus Center**  
Phone: 81-3-5773-3850

**ON Semiconductor Website:** [www.onsemi.com](http://www.onsemi.com)  
**Order Literature:** <http://www.onsemi.com/orderlit>  
For additional information, please contact your local Sales Representative