

# NPN RF Transistor

## MMBT5179

### Description

This device is designed for use in low noise UHF/VHF amplifiers with collector currents in the 100  $\mu$ A to 30 mA range in common emitter or common base mode of operation, and in low frequency drift, high output UHF oscillators. Sourced from Process 40.

### Features

- This Device is Pb-Free, Halogen Free/BFR Free and is RoHS Compliant

### ABSOLUTE MAXIMUM RATINGS ( $T_A = 25^\circ\text{C}$ unless otherwise noted)

Symbol	Parameter	Value	Unit
$V_{CEO}$	Collector-Emitter Voltage	12	V
$V_{CBO}$	Collector-Base Voltage	20	V
$V_{EBO}$	Emitter-Base Voltage	2.5	V
$I_C$	Collector Current - Continuous	50	mA
$T_J, T_{stg}$	Operating and Storage Junction Temperature Range (Note 1)	-55 to +150	$^\circ\text{C}$

Stresses exceeding those listed in the Maximum Ratings table may damage the device. If any of these limits are exceeded, device functionality should not be assumed, damage may occur and reliability may be affected.

### THERMAL CHARACTERISTICS

( $T_A = 25^\circ\text{C}$  unless otherwise noted) (Note 3)

Symbol	Characteristic	Max	Unit
$P_D$	Total Device Dissipation Derate above $25^\circ\text{C}$	225 1.8	MW mW/ $^\circ\text{C}$
$R_{\theta JA}$	Thermal Resistance, Junction to Ambient	556	$^\circ\text{C}/\text{W}$

- These ratings are based on a maximum junction temperature of  $150^\circ\text{C}$ .
- These are steady-state limits. onsemi should be consulted on applications involving pulsed or low-duty cycle operations.
- Device mounted on FR-4 PCB  $1.6'' \times 1.6'' \times 0.06''$ .

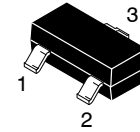

1. Base 2. Emitter 3. Collector

SOT-23  
CASE 318-08

### MARKING DIAGRAM

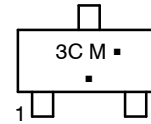

3C = Specific Device Code  
M = Date Code\*  
▪ = Pb-Free Package

(Note: Microdot may be in either location)

\*Date Code orientation and/or overbar may vary depending upon manufacturing location.

### ORDERING INFORMATION

Device	Package	Shipping <sup>†</sup>
MMBT5179	SOT-23 (Pb-Free)	3000 / Tape and Reel

<sup>†</sup>For information on tape and reel specifications, including part orientation and tape sizes, please refer to our Tape and Reel Packaging Specification Brochure, [BRD8011/D](#).

# MMBT5179

## ELECTRICAL CHARACTERISTICS ( $T_A = 25^\circ\text{C}$ unless otherwise noted)

Symbol	Parameter	Test Conditions	Min	Max	Unit
$V_{CE(sus)}$	Collector–Emitter Sustaining Voltage (Note 4)	$I_C = 3.0\text{ mA}$ , $I_B = 0$	12		V
$V_{(BR)CBO}$	Collector–Base Breakdown Voltage	$I_C = 1.0\ \mu\text{A}$ , $I_E = 0$	20		V
$V_{(BR)EBO}$	Emitter–Base Breakdown Voltage	$I_E = 10\ \mu\text{A}$ , $I_C = 0$	2.5		V
$I_{CBO}$	Collector Cut–Off Current	$V_{CB} = 15\text{ V}$ , $I_E = 0$		0.02	$\mu\text{A}$
		$V_{CB} = 15\text{ V}$ , $T_A = 150^\circ\text{C}$		1.0	$\mu\text{A}$

## ON CHARACTERISTICS

$h_{FE}$	DC Current Gain	$I_C = 3.0\text{ mA}$ , $V_{CE} = 1.0\text{ V}$	25	250	
$V_{CE(sat)}$	Collector–Emitter Saturation Voltage	$I_C = 10\text{ mA}$ , $I_B = 1.0\text{ mA}$		0.4	V
$V_{BE(sat)}$	Base–Emitter Saturation Voltage	$I_C = 10\text{ mA}$ , $I_B = 1.0\text{ mA}$		1.0	V

## SMALL SIGNAL CHARACTERISTICS

$f_T$	Current Gain – Bandwidth Product	$I_C = 5.0\text{ mA}$ , $V_{CE} = 6.0\text{ V}$ , $f = 100\text{ MHz}$	900	2000	MHz
$C_{cb}$	Collector–Base Capacitance	$V_{CB} = 10\text{ V}$ , $I_E = 0$ , $f = 0.1\text{ to }1.0\text{ MHz}$		1.0	pF
$h_{fe}$	Small–Signal Current Gain	$I_C = 2.0\text{ mA}$ , $V_{CE} = 6\text{ V}$ , $f = 1.0\text{ kHz}$	25	300	
$rb'C_c$	Collector Base Time Constant	$I_C = 2.0\text{ mA}$ , $V_{CB} = 6.0\text{ V}$ , $f = 31.9\text{ MHz}$	3.0	14	ps
NF	Noise Figure	$I_C = 1.5\text{ mA}$ , $V_{CE} = 6.0\text{ V}$ , $R_S = 50\ \Omega$ , $f = 200\text{ MHz}$		5.0	dB

## FUNCTIONAL TEST

$G_{pe}$	Amplifier Power Gain	$V_{CE} = 6.0\text{ V}$ , $I_C = 5.0\text{ mA}$ , $f = 200\text{ MHz}$	15		dB
$P_O$	Power Output	$V_{CB} = 10\text{ V}$ , $I_E = 12\text{ mA}$ , $f \geq 500\text{ MHz}$	20		mW

Product parametric performance is indicated in the Electrical Characteristics for the listed test conditions, unless otherwise noted. Product performance may not be indicated by the Electrical Characteristics if operated under different conditions.

4. Pulse Test: Pulse Width  $\leq 300\ \mu\text{s}$ , Duty Cycle  $\leq 2.0\%$ .

## SPICE MODEL

NPN ( $I_s=69.28\text{E}-18$   $X_{ti}=3$   $E_g=1.11$   $V_{af}=100$   $B_f=282.1$   $N_e=1.177$   $I_{se}=69.28\text{E}-18$   $I_{kf}=22.03\text{m}$   $X_{tb}=1.5$   $B_r=1.176$   $N_c=2$   $I_{sc}=0$   $I_{kr}=0$   $R_c=4$   $C_{jc}=1.042\text{p}$   $M_{jc}=.2468$   $V_{jc}=.75$   $F_c=.5$   $C_{je}=1.52\text{p}$   $M_{je}=.3223$   $V_{je}=.75$   $T_r=1.588\text{n}$   $T_f=135.6\text{p}$   $I_{tf}=.27$   $V_{tf}=10$   $X_{tf}=30$   $R_b=10$ )

TYPICAL CHARACTERISTICS

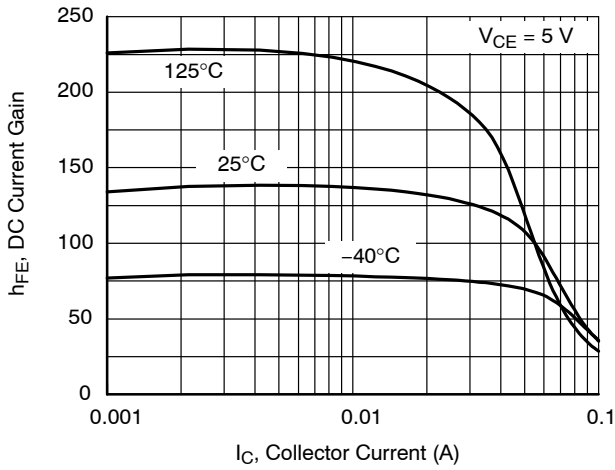

Figure 1. DC Current Gain vs. Collector Current

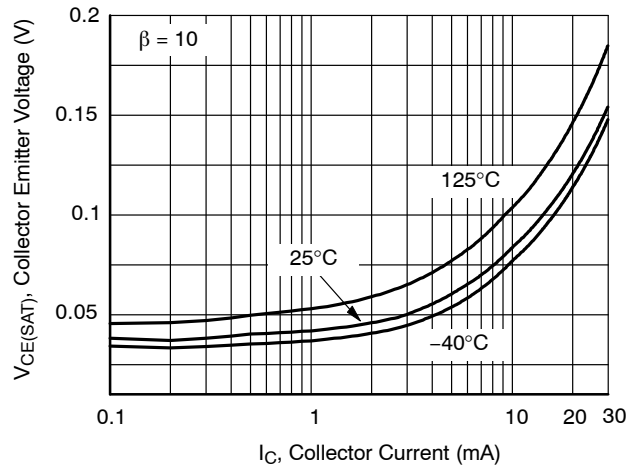

Figure 2. Collector-Emitter Saturation Voltage vs. Collector Current

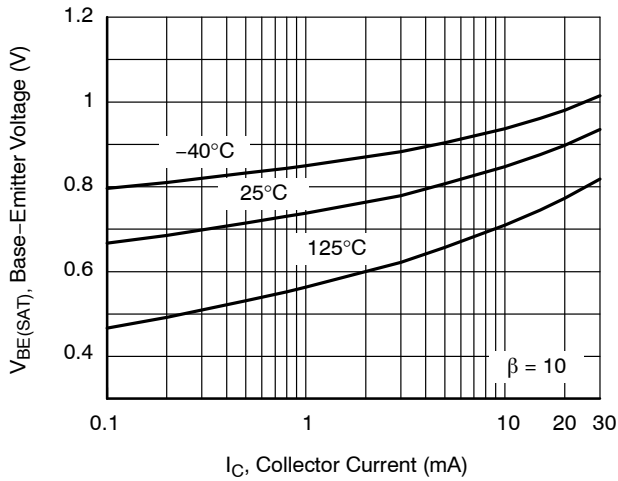

Figure 3. Base-Emitter Saturation Voltage vs. Collector Current

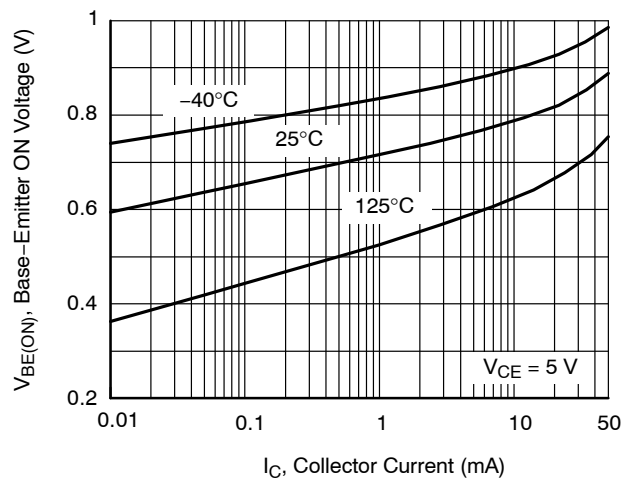

Figure 4. Base-Emitter ON Voltage vs. Collector Current

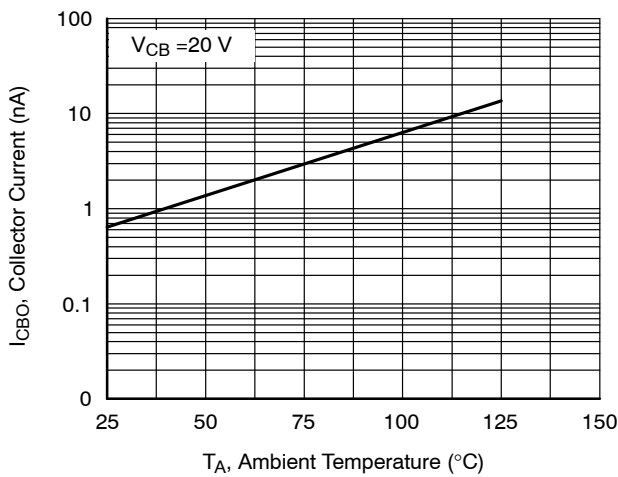

Figure 5. Collector Cut-Off Current vs. Ambient Temperature

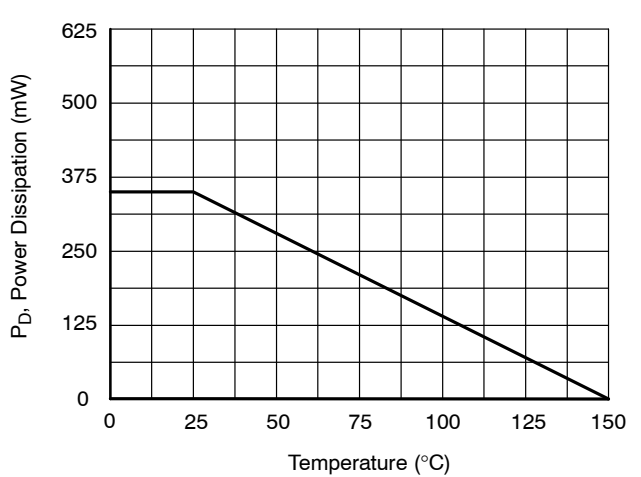

Figure 6. Power Dissipation vs. Ambient Temperature

# MMBT5179

## TEST CIRCUIT

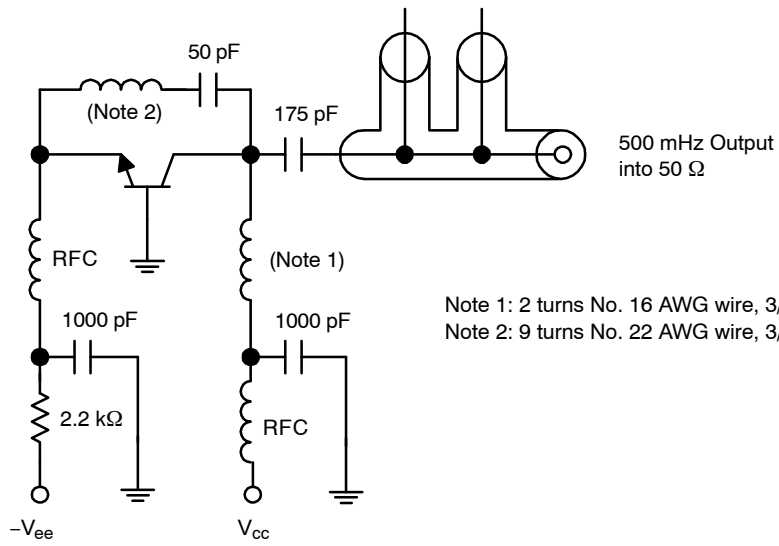

Figure 7. 500 MHz Oscillator Circuit

**onsemi**, **Onsemi**, and other names, marks, and brands are registered and/or common law trademarks of Semiconductor Components Industries, LLC dba "**onsemi**" or its affiliates and/or subsidiaries in the United States and/or other countries. **onsemi** owns the rights to a number of patents, trademarks, copyrights, trade secrets, and other intellectual property. A listing of **onsemi**'s product/patent coverage may be accessed at [www.onsemi.com/site/pdf/Patent-Marking.pdf](http://www.onsemi.com/site/pdf/Patent-Marking.pdf). **onsemi** reserves the right to make changes at any time to any products or information herein, without notice. The information herein is provided "as-is" and **onsemi** makes no warranty, representation or guarantee regarding the accuracy of the information, product features, availability, functionality, or suitability of its products for any particular purpose, nor does **onsemi** assume any liability arising out of the application or use of any product or circuit, and specifically disclaims any and all liability, including without limitation special, consequential or incidental damages. Buyer is responsible for its products and applications using **onsemi** products, including compliance with all laws, regulations and safety requirements or standards, regardless of any support or applications information provided by **onsemi**. "Typical" parameters which may be provided in **onsemi** data sheets and/or specifications can and do vary in different applications and actual performance may vary over time. All operating parameters, including "Typicals" must be validated for each customer application by customer's technical experts. **onsemi** does not convey any license under any of its intellectual property rights nor the rights of others. **onsemi** products are not designed, intended, or authorized for use as a critical component in life support systems or any FDA Class 3 medical devices or medical devices with a same or similar classification in a foreign jurisdiction or any devices intended for implantation in the human body. Should Buyer purchase or use **onsemi** products for any such unintended or unauthorized application, Buyer shall indemnify and hold **onsemi** and its officers, employees, subsidiaries, affiliates, and distributors harmless against all claims, costs, damages, and expenses, and reasonable attorney fees arising out of, directly or indirectly, any claim of personal injury or death associated with such unintended or unauthorized use, even if such claim alleges that **onsemi** was negligent regarding the design or manufacture of the part. **onsemi** is an Equal Opportunity/Affirmative Action Employer. This literature is subject to all applicable copyright laws and is not for resale in any manner.

---

## ADDITIONAL INFORMATION

### TECHNICAL PUBLICATIONS:

Technical Library: [www.onsemi.com/design/resources/technical-documentation](http://www.onsemi.com/design/resources/technical-documentation)  
onsemi Website: [www.onsemi.com](http://www.onsemi.com)

### ONLINE SUPPORT: [www.onsemi.com/support](http://www.onsemi.com/support)

For additional information, please contact your local Sales Representative at [www.onsemi.com/support/sales](http://www.onsemi.com/support/sales)