

MJE18006G

Switch-mode

NPN Bipolar Power Transistor For Switching Power Supply Applications

The MJE18006G has an applications specific state-of-the-art die designed for use in 220 V line-operated switch-mode power supplies and electronic light ballasts.

Features

- Improved Efficiency Due to Low Base Drive Requirements:
 - ◆ High and Flat DC Current Gain h_{FE}
 - ◆ Fast Switching
 - ◆ No Coil Required in Base Circuit for Turn-Off (No Current Tail)
- Tight Parametric Distributions are Consistent Lot-to-Lot
- Standard TO-220
- These Devices are Pb-Free and are RoHS Compliant*

MAXIMUM RATINGS

Rating	Symbol	Value	Unit
Collector-Emitter Sustaining Voltage	V_{CEO}	450	Vdc
Collector-Emitter Breakdown Voltage	V_{CES}	1000	Vdc
Emitter-Base Voltage	V_{EBO}	9.0	Vdc
Collector Current – Continuous	I_C	6.0	Adc
– Peak (Note 1)	I_{CM}	15	
Base Current – Continuous	I_B	4.0	Adc
– Peak (Note 1)	I_{BM}	8.0	
Total Device Dissipation @ $T_C = 25^\circ\text{C}$ Derate above 25°C	P_D	100 0.8	W W/ $^\circ\text{C}$
Operating and Storage Temperature	T_J, T_{stg}	-65 to 150	$^\circ\text{C}$

THERMAL CHARACTERISTICS

Characteristics	Symbol	Max	Unit
Thermal Resistance, Junction-to-Case	$R_{\theta JC}$	1.25	$^\circ\text{C}/\text{W}$
Thermal Resistance, Junction-to-Ambient	$R_{\theta JA}$	62.5	$^\circ\text{C}/\text{W}$
Maximum Lead Temperature for Soldering Purposes 1/8" from Case for 5 Seconds	T_L	260	$^\circ\text{C}$

Stresses exceeding Maximum Ratings may damage the device. Maximum Ratings are stress ratings only. Functional operation above the Recommended Operating Conditions is not implied. Extended exposure to stresses above the Recommended Operating Conditions may affect device reliability.

1. Pulse Test: Pulse Width = 5 ms, Duty Cycle $\leq 10\%$.



ON Semiconductor®

<http://onsemi.com>

**POWER TRANSISTOR
6.0 AMPERES
1000 VOLTS – 100 WATTS**

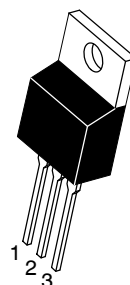

TO-220AB
CASE 221A-09
STYLE 1

MARKING DIAGRAM

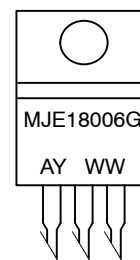

A = Assembly Location
Y = Year
WW = Work Week
G = Pb-Free Package

ORDERING INFORMATION

Device	Package	Shipping
MJE18006G	TO-220 (Pb-Free)	50 Units / Rail

*For additional information on our Pb-Free strategy and soldering details, please download the ON Semiconductor Soldering and Mounting Techniques Reference Manual, SOLDERRM/D.

MJE18006G

ELECTRICAL CHARACTERISTICS (T_C = 25°C unless otherwise specified)

Characteristic	Symbol	Min	Typ	Max	Unit
OFF CHARACTERISTICS					
Collector–Emitter Sustaining Voltage (I _C = 100 mA, L = 25 mH)	V _{CEO(sus)}	450	–	–	Vdc
Collector Cutoff Current (V _{CE} = Rated V _{CEO} , I _B = 0)	I _{CEO}	–	–	100	μAdc
Collector Cutoff Current (V _{CE} = Rated V _{CE(s)} , V _{EB} = 0)	I _{CES}	–	–	100	μAdc
		–	–	500	
(V _{CE} = 800 V, V _{EB} = 0)		–	–	100	
Emitter Cutoff Current (V _{EB} = 9.0 Vdc, I _C = 0)	I _{EBO}	–	–	100	μAdc

ON CHARACTERISTICS

Base–Emitter Saturation Voltage (I _C = 1.3 Adc, I _B = 0.13 Adc) (I _C = 3.0 Adc, I _B = 0.6 Adc)	V _{BE(sat)}	–	0.83 0.94	1.2 1.3	Vdc
Collector–Emitter Saturation Voltage (I _C = 1.3 Adc, I _B = 0.13 Adc)	V _{CE(sat)}	–	0.25	0.6	Vdc
		–	0.27	0.65	
(I _C = 3.0 Adc, I _B = 0.6 Adc)		–	0.35	0.7	
		–	0.4	0.8	
DC Current Gain (I _C = 0.5 Adc, V _{CE} = 5.0 Vdc)	h _{FE}	14	–	34	–
		–	32	–	
(I _C = 3.0 Adc, V _{CE} = 1.0 Vdc)		6.0	10	–	
		5.0	8.0	–	
(I _C = 1.3 Adc, V _{CE} = 1.0 Vdc)		11	17	–	
(I _C = 10 mAdc, V _{CE} = 5.0 Vdc)		10	22	–	

DYNAMIC CHARACTERISTICS

Current Gain Bandwidth (I _C = 0.5 Adc, V _{CE} = 10 Vdc, f = 1.0 MHz)	f _T	–	14	–	MHz			
Output Capacitance (V _{CB} = 10 Vdc, I _E = 0, f = 1.0 MHz)	C _{ob}	–	75	120	pF			
Input Capacitance (V _{EB} = 8.0 V)	C _{ib}	–	1000	1500	pF			
Dynamic Saturation Voltage:	V _{CE(dsat)}	(I _C = 1.3 Adc, I _{B1} = 130 mAdc, V _{CC} = 300 V)	1.0 μs	(T _C = 125°C)	–	5.5	–	V
Determined 1.0 μs and 3.0 μs respectively after rising I _{B1} reaches 90% of final I _{B1} (see Figure 18)			3.0 μs	(T _C = 125°C)	–	3.0	–	–
		(I _C = 3.0 Adc, I _{B1} = 0.6 Adc, V _{CC} = 300 V)	1.0 μs	(T _C = 125°C)	–	9.5	–	–
			3.0 μs	(T _C = 125°C)	–	14.5	–	–
						–	2.0	–
						7.5	–	–

SWITCHING CHARACTERISTICS: Resistive Load (D.C. ≤ 10%, Pulse Width = 20 μs)

Turn–On Time	(I _C = 3.0 Adc, I _{B1} = 0.6 Adc, I _{B2} = 1.5 Adc, V _{CC} = 300 V)	(T _C = 125°C)	t _{on}	–	90 100	180 –	ns
Turn–Off Time			t _{off}	–	1.7 2.1	2.5 –	μs
Turn–On Time	(I _C = 1.3 Adc, I _{B1} = 0.13 Adc, I _{B2} = 0.65 Adc, V _{CC} = 300 V)	(T _C = 125°C)	t _{on}	–	200 130	300 –	ns
Turn–Off Time			t _{off}	–	1.2 1.5	2.5 –	μs

SWITCHING CHARACTERISTICS: Inductive Load (V_{clamp} = 300 V, V_{CC} = 15 V, L = 200 μH)

Fall Time	(I _C = 1.5 Adc, I _{B1} = 0.13 Adc, I _{B2} = 0.65 Adc)	(T _C = 125°C)	t _{fi}	–	100 120	180 –	ns
Storage Time			t _{si}	–	1.5 1.9	2.5 –	μs
Crossover Time			t _c	–	220 230	350 –	ns
Fall Time	(I _C = 3.0 Adc, I _{B1} = 0.6 Adc, I _{B2} = 1.5 Adc)	(T _C = 125°C)	t _{fi}	–	85 120	150 –	ns
Storage Time			t _{si}	–	2.15 2.75	3.2 –	μs
Crossover Time			t _c	–	200 310	300 –	ns

2. Proper strike and creepage distance must be provided.

TYPICAL STATIC CHARACTERISTICS

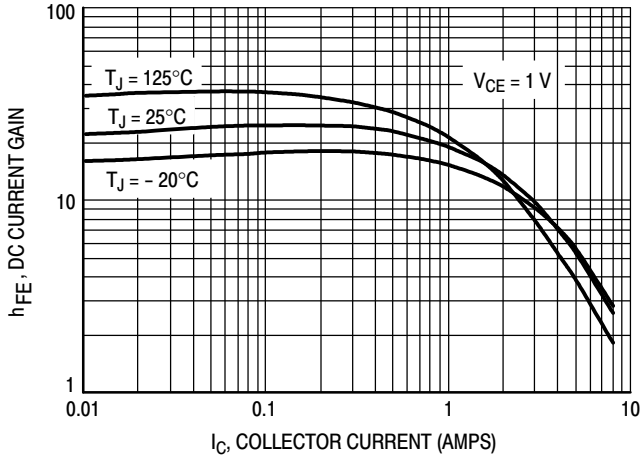

Figure 1. DC Current Gain @ 1 Volt

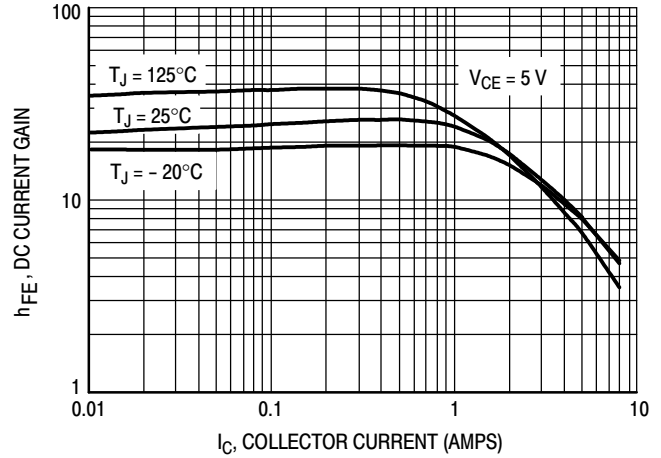

Figure 2. DC Current Gain @ 5 Volts

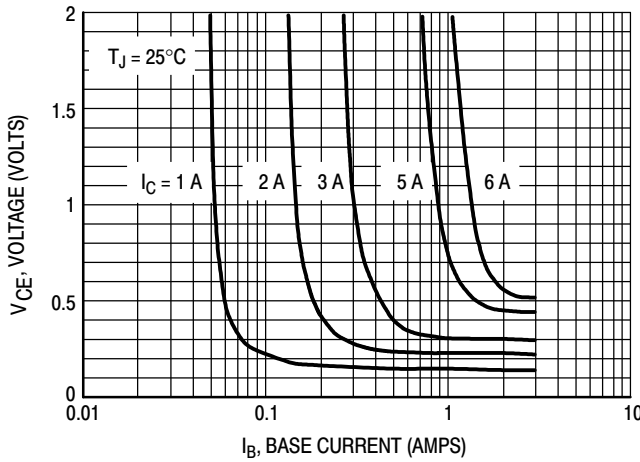

Figure 3. Collector Saturation Region

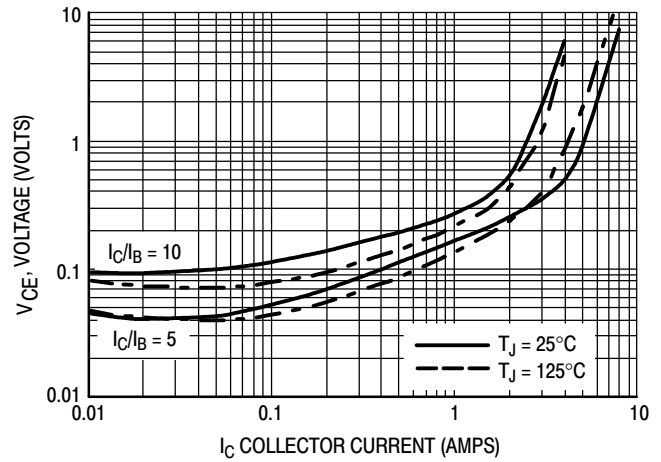

Figure 4. Collector-Emitter Saturation Voltage

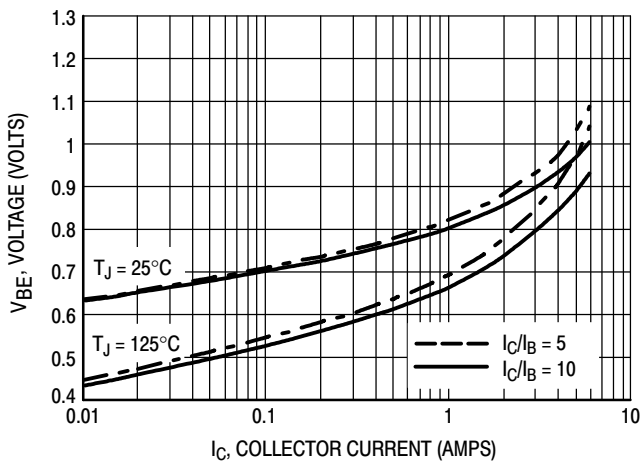

Figure 5. Base-Emitter Saturation Region

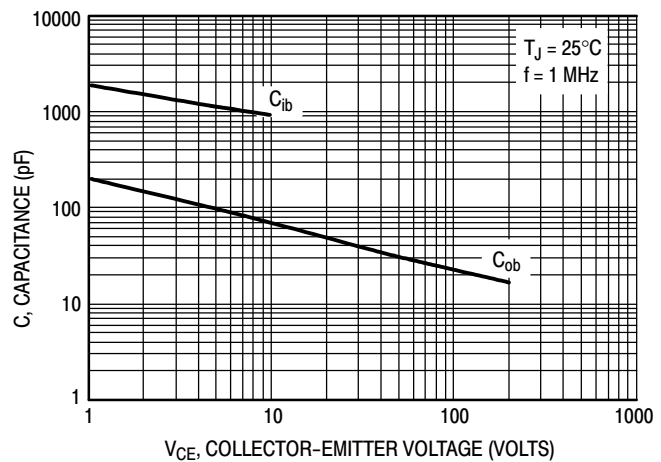

Figure 6. Capacitance

TYPICAL SWITCHING CHARACTERISTICS
($I_{B2} = I_C/2$ for all switching)

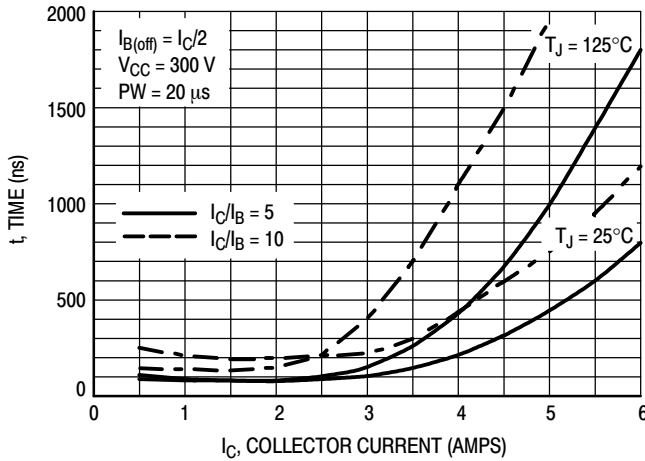

Figure 7. Resistive Switching, t_{on}

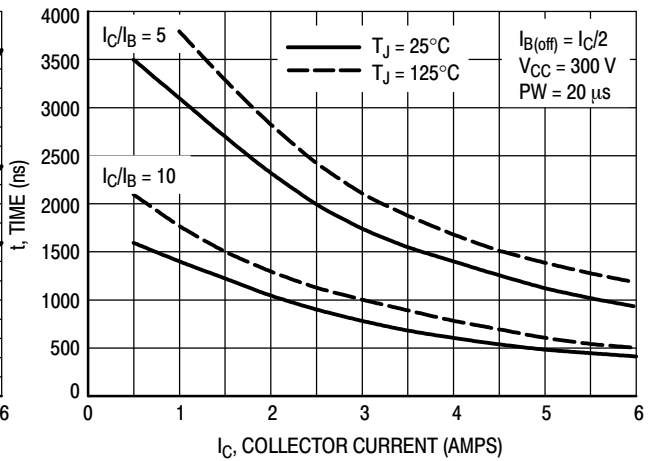

Figure 8. Resistive Switching, t_{off}

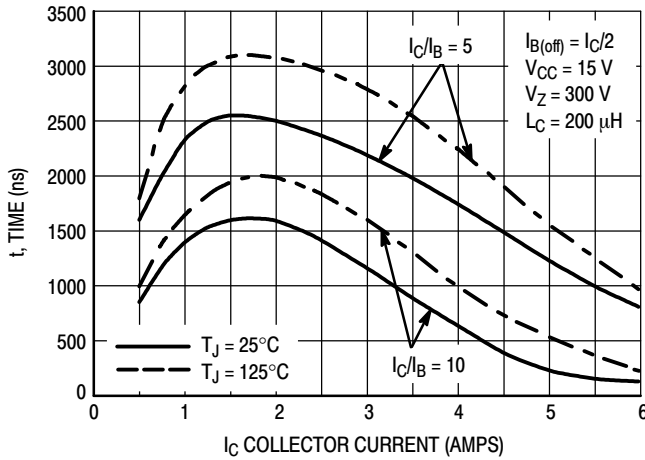

Figure 9. Inductive Storage Time, t_{si}

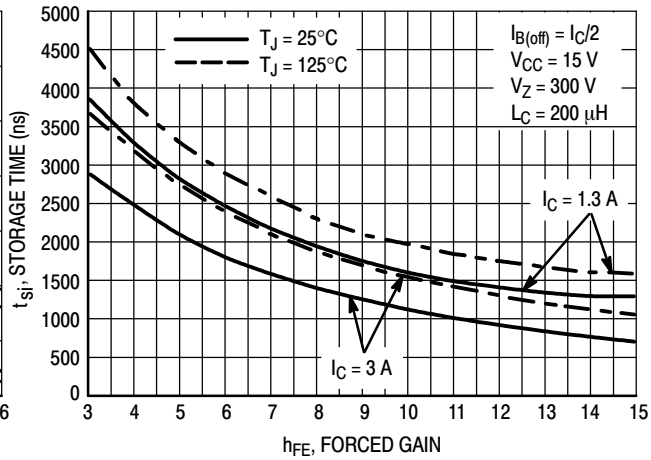

Figure 10. Inductive Storage Time, $t_{si}(h_{FE})$

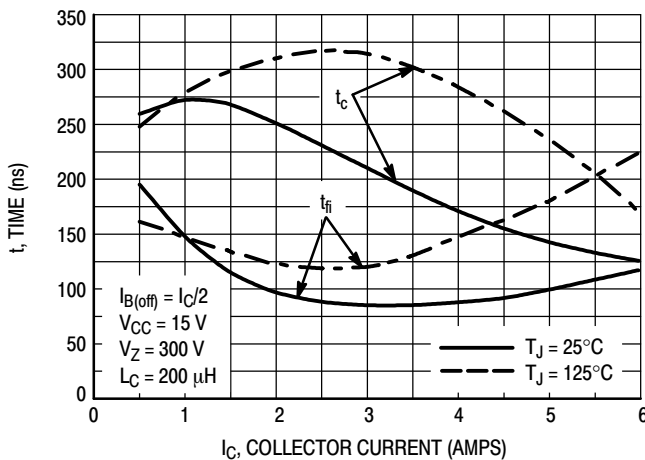

Figure 11. Inductive Switching, t_c and t_{fi}
 $I_C/I_B = 5$

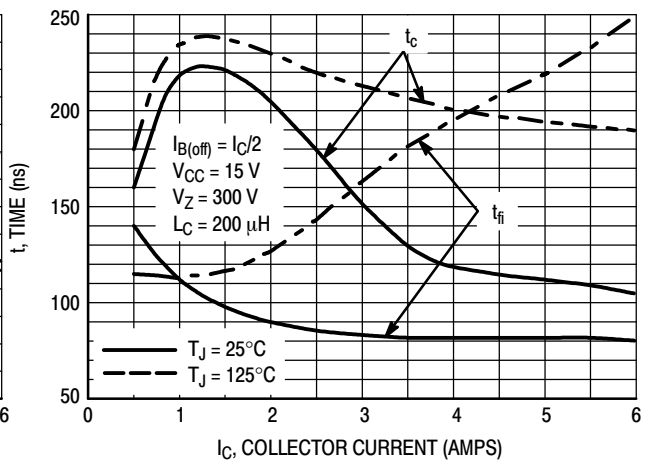

Figure 12. Inductive Switching, t_c and t_{fi}
 $I_C/I_B = 10$

TYPICAL SWITCHING CHARACTERISTICS
($I_{B2} = I_C/2$ for all switching)

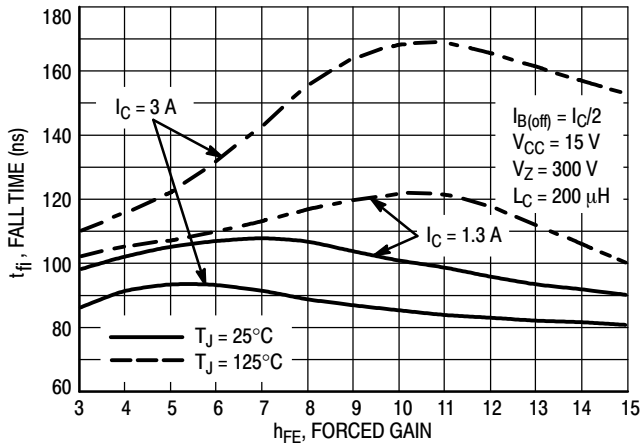

Figure 13. Inductive Fall Time

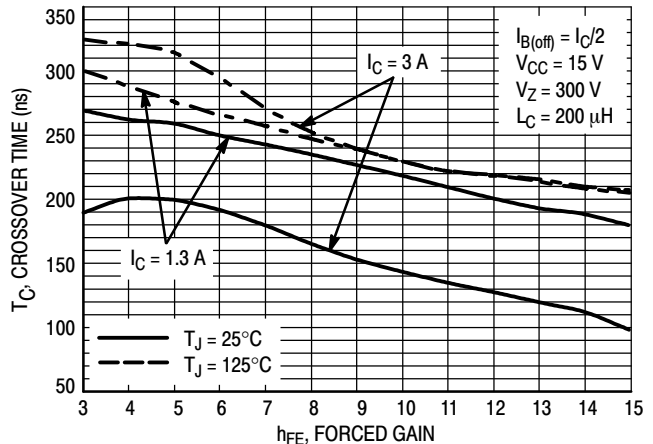

Figure 14. Inductive Crossover Time

GUARANTEED SAFE OPERATING AREA INFORMATION

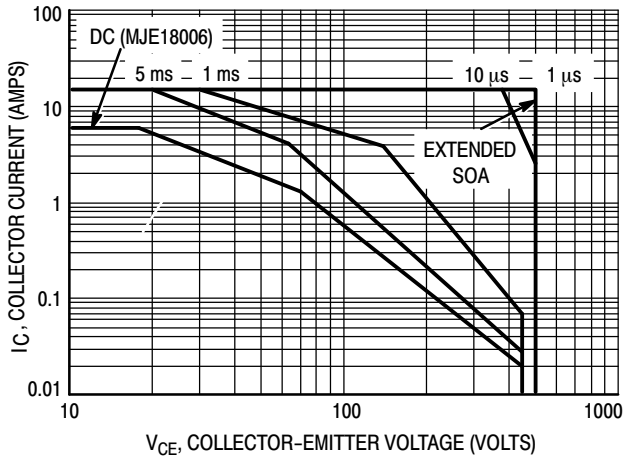

Figure 15. Forward Bias Safe Operating Area

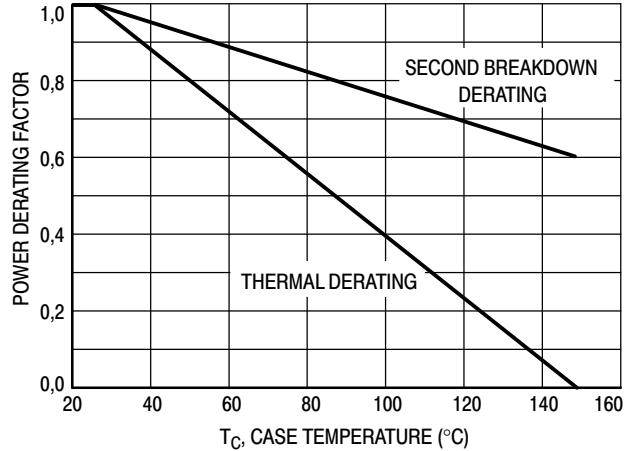

Figure 17. Forward Bias Power Derating

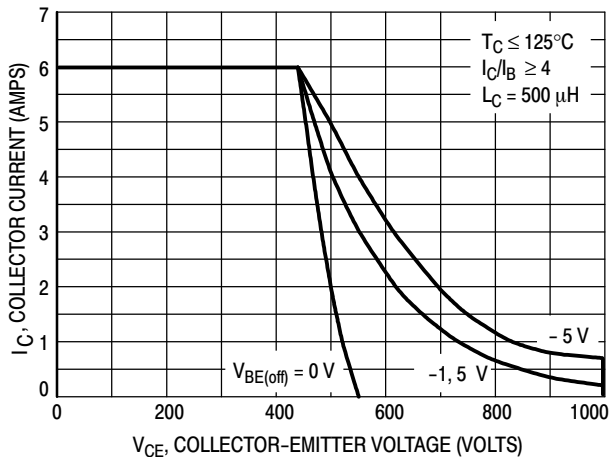

Figure 16. Reverse Bias Switching Safe Operating Area

There are two limitations on the power handling ability of a transistor: average junction temperature and second breakdown. Safe operating area curves indicate $I_C - V_{CE}$ limits of the transistor that must be observed for reliable

operation; i.e., the transistor must not be subjected to greater dissipation than the curves indicate. The data of Figure 15 is based on $T_C = 25^\circ\text{C}$; $T_{J(pk)}$ is variable depending on power level. Second breakdown pulse limits are valid for duty cycles to 10% but must be derated when $T_C \geq 25^\circ\text{C}$. Second breakdown limitations do not derate the same as thermal limitations. Allowable current at the voltages shown in Figure 15 may be found at any case temperature by using the appropriate curve on Figure 17. $T_{J(pk)}$ may be calculated from the data in Figure 20. At any case temperatures, thermal limitations will reduce the power that can be handled to values less than the limitations imposed by second breakdown. For inductive loads, high voltage and current must be sustained simultaneously during turn-off with the base-to-emitter junction reverse-biased. The safe level is specified as a reverse-biased safe operating area (Figure 16). This rating is verified under clamped conditions so that the device is never subjected to an avalanche mode.

MJE18006G

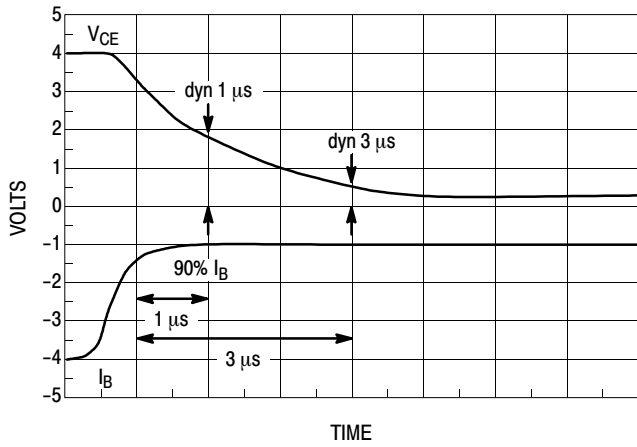

Figure 18. Dynamic Saturation Voltage Measurements

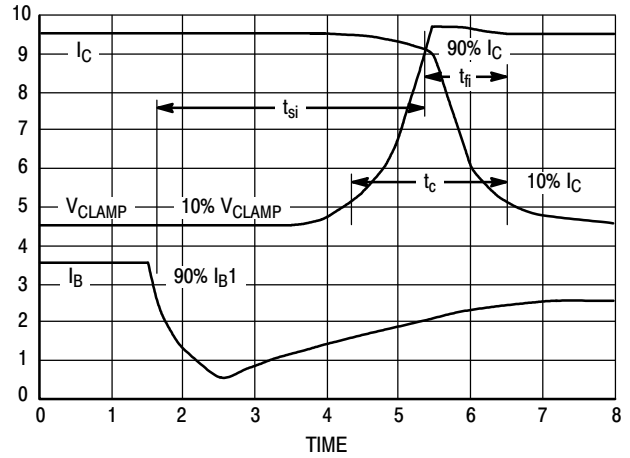
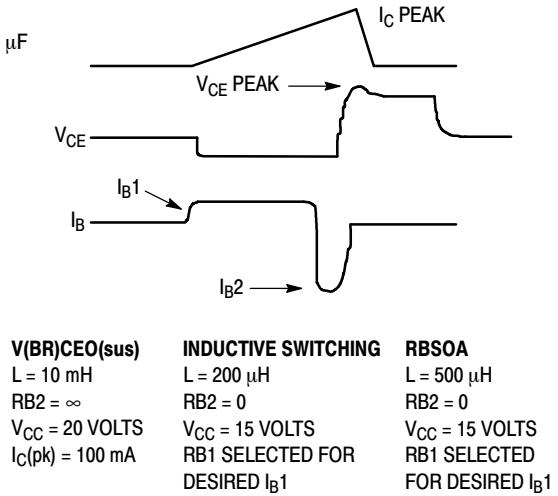
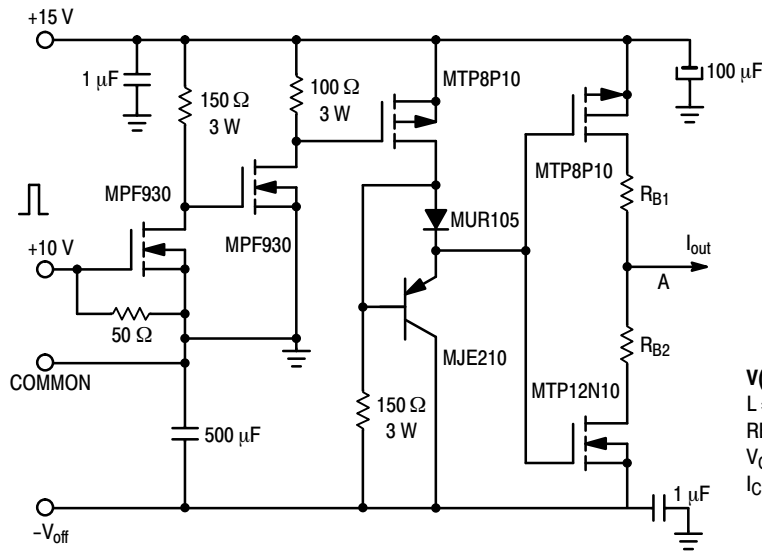

Figure 19. Inductive Switching Measurements



V(BR)CEO(sus)	INDUCTIVE SWITCHING	RBSOA
L = 10 mH	L = 200 μH	L = 500 μH
RB2 = ∞	RB2 = 0	RB2 = 0
V _{CC} = 20 VOLTS	V _{CC} = 15 VOLTS	V _{CC} = 15 VOLTS
I _{C(pk)} = 100 mA	RB1 SELECTED FOR DESIRED I _{B1}	RB1 SELECTED FOR DESIRED I _{B1}

Table 1. Inductive Load Switching Drive Circuit

TYPICAL THERMAL RESPONSE

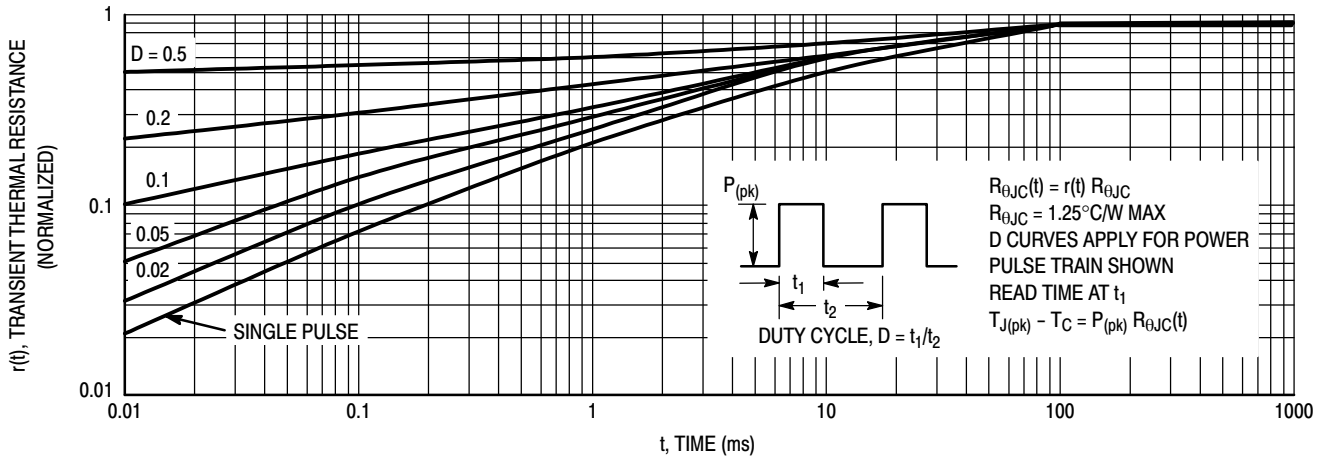

Figure 20. Typical Thermal Response ($Z_{\theta JC}(t)$) for MJE18006

onsemi, **Onsemi**, and other names, marks, and brands are registered and/or common law trademarks of Semiconductor Components Industries, LLC dba "**onsemi**" or its affiliates and/or subsidiaries in the United States and/or other countries. **onsemi** owns the rights to a number of patents, trademarks, copyrights, trade secrets, and other intellectual property. A listing of **onsemi**'s product/patent coverage may be accessed at www.onsemi.com/site/pdf/Patent-Marking.pdf. **onsemi** reserves the right to make changes at any time to any products or information herein, without notice. The information herein is provided "as-is" and **onsemi** makes no warranty, representation or guarantee regarding the accuracy of the information, product features, availability, functionality, or suitability of its products for any particular purpose, nor does **onsemi** assume any liability arising out of the application or use of any product or circuit, and specifically disclaims any and all liability, including without limitation special, consequential or incidental damages. Buyer is responsible for its products and applications using **onsemi** products, including compliance with all laws, regulations and safety requirements or standards, regardless of any support or applications information provided by **onsemi**. "Typical" parameters which may be provided in **onsemi** data sheets and/or specifications can and do vary in different applications and actual performance may vary over time. All operating parameters, including "Typicals" must be validated for each customer application by customer's technical experts. **onsemi** does not convey any license under any of its intellectual property rights nor the rights of others. **onsemi** products are not designed, intended, or authorized for use as a critical component in life support systems or any FDA Class 3 medical devices or medical devices with a same or similar classification in a foreign jurisdiction or any devices intended for implantation in the human body. Should Buyer purchase or use **onsemi** products for any such unintended or unauthorized application, Buyer shall indemnify and hold **onsemi** and its officers, employees, subsidiaries, affiliates, and distributors harmless against all claims, costs, damages, and expenses, and reasonable attorney fees arising out of, directly or indirectly, any claim of personal injury or death associated with such unintended or unauthorized use, even if such claim alleges that **onsemi** was negligent regarding the design or manufacture of the part. **onsemi** is an Equal Opportunity/Affirmative Action Employer. This literature is subject to all applicable copyright laws and is not for resale in any manner.

ADDITIONAL INFORMATION

TECHNICAL PUBLICATIONS:

Technical Library: www.onsemi.com/design/resources/technical-documentation
onsemi Website: www.onsemi.com

ONLINE SUPPORT: www.onsemi.com/support

For additional information, please contact your local Sales Representative at www.onsemi.com/support/sales

