

Full-Function Load Switch with Adjustable Current Limit



WLCSP6 1.48x0.98x0.582
CASE 567RN

FPF2193, FPF2194, FPF2195

Description

The FPF2193, FPF2194, and FPF2195 form a series of load switches that provides full protection to systems and loads that may encounter large current conditions. These devices contain a 55 mΩ current-limited P-channel MOSFET that can operate over an input voltage range of 1.8 to 5.5 V. Internally, current is prevented from flowing when the MOSFET is off and the output voltage is higher than the input voltage. Switch control is by a logic input (ON) capable of interfacing directly with low-voltage control signals. Each part contains thermal shutdown protection that shuts off the switch to prevent damage to the part when a continuous over-current condition causes excessive heating.

When the switch current reaches the current limit, the parts operate in a constant-current mode to prohibit excessive currents from causing damage. For the FPF2193 and FPF2194, if the constant current condition still persists after 30 ms, the parts shut off the switch and pull the fault signal pin (FLAGB) LOW. The FPF2193 has an auto-restart feature that turns the switch on again after 450 ms if the ON pin is still active. The FPF2194 does not have this auto-restart feature, so the switch remains off until the ON pin is cycled. The FPF2195 does not turn off after a current limit fault, but remains in the constant-current mode indefinitely. The minimum current limit can be set as low as 45 mA.

These parts are available in a space-saving six ball advanced 0.98 x 1.48 mm WLCSP package.

Features

- <1.8 to 5.5 V Input Voltage Range
- Controlled Turn-On
- 0.1 to 1.5 A Adjustable Current Limit
- Under-Voltage Lockout
- Thermal Shutdown
- <2 μA Shutdown Current
- Auto Restart
- Fast Current Limit Response Time
- 5 μs to Moderate Over Currents
- 30 ns to Hard Shorts
- Fault Blanking
- Reverse Current Blocking

MARKING DIAGRAM

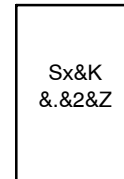

- Sx = Device Code (x = 6, 7, 9, Y)
- &K = 2-Digits Lot Run Traceability Code
- &. = Pin One Dot
- &2 = 2-Digit Date Code
- &Z = Assembly Plant Code

ORDERING INFORMATION

See detailed ordering and shipping information on page 13 of this data sheet.

Applications

- PDAs
- Cell Phones
- Handheld GPS Devices
- Portable Enterprise / Industrial Devices
- Digital Cameras
- Peripheral Ports and Accessories
- Portable Medical Equipment
- Hot Swap Supplies

FPF2193, FPF2194, FPF2195

APPLICATION DIAGRAM

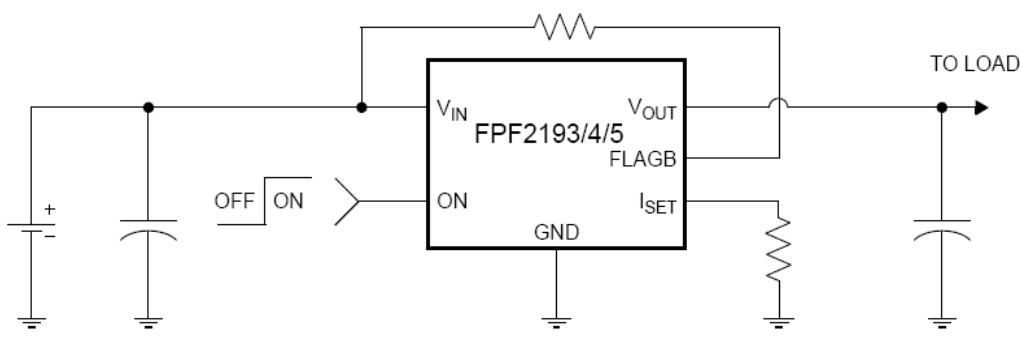

Figure 1. Typical Application

BLOCK DIAGRAM

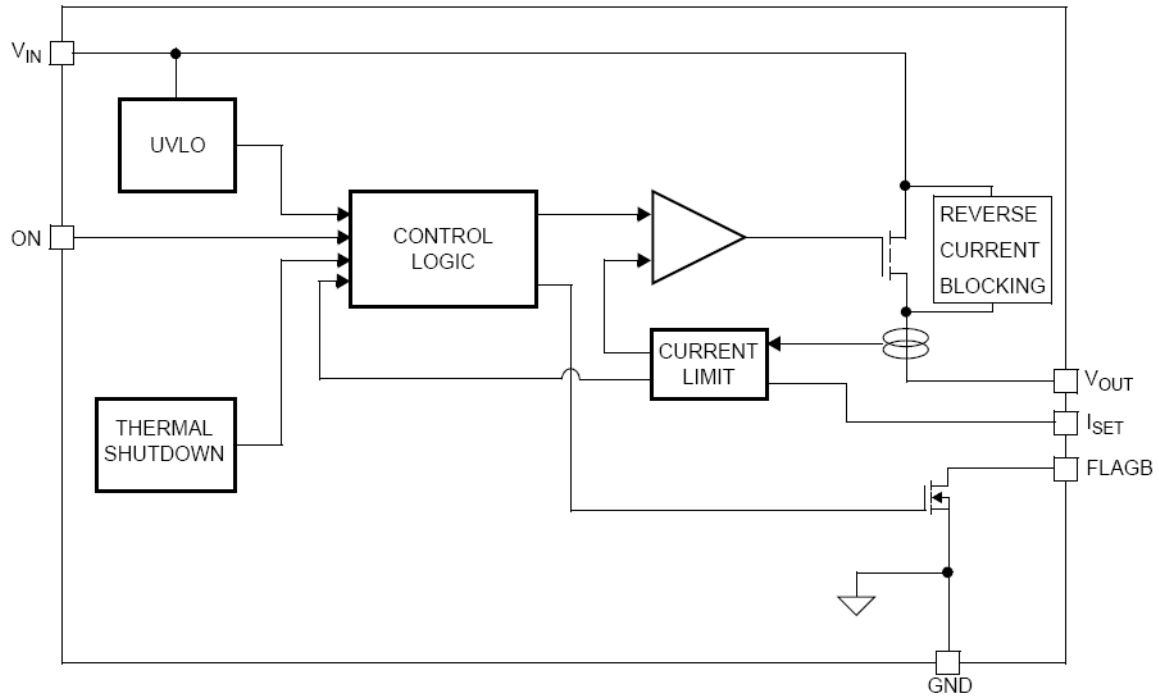

Figure 2. Functional Block Diagram

FPF2193, FPF2194, FPF2195

PIN CONFIGURATION

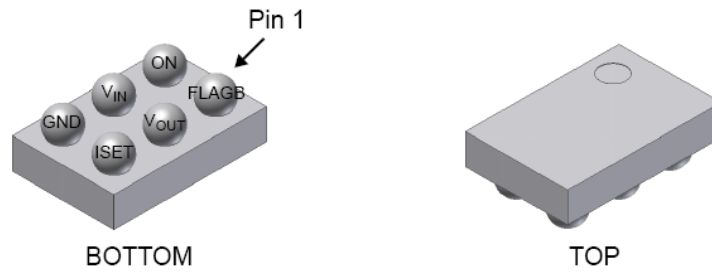

Figure 3. 1.0 x 1.5 mm Chip-Scale Package

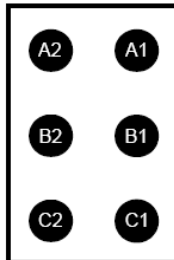

Figure 4. Pin Configuration (Bottom View)

PIN DEFINITIONS

| Pin No. | Symbol | Description |
|---------|------------------|--|
| C1 | ISET | Current Limit Set Input. A resistor from ISET to ground sets the current limit for the switch. |
| B2 | V _{IN} | Supply Input. Input to the power switch and the supply voltage for the IC. |
| B1 | V _{OUT} | Switch Output. Output of the power switch. |
| A1 | FLAGB | Fault Output. Active LOW, open-drain output that indicates an over-current supply, under-voltage, or over-temperature state. |
| C2 | GND | Ground. |
| A2 | ON | ON control input, active HIGH. |

FPF2193, FPF2194, FPF2195

ABSOLUTE MAXIMUM RATINGS

| Symbol | Parameter | Min | Max | Unit | |
|---------------|--|-------------------------------|------|---------------------------|---|
| | V_{IN} , V_{OUT} , ON, FLAGB, ISET to GND | -0.3 | 6.0 | V | |
| P_D | Power Dissipation at $T_A = 25^\circ\text{C}$ (Note 1) | - | 1.2 | W | |
| T_J | Operating Temperature Range | -40 | +125 | $^\circ\text{C}$ | |
| T_{STG} | Storage Temperature | -65 | +150 | $^\circ\text{C}$ | |
| Θ_{JA} | Thermal Resistance, Junction to Ambient | - | 85 | $^\circ\text{C}/\text{W}$ | |
| ESD | Electrostatic Discharge Capability | Human Body Model, JESD22-A114 | 8000 | - | V |
| | | Machine Model, JESD22-A115 | 400 | - | |

Stresses exceeding those listed in the Maximum Ratings table may damage the device. If any of these limits are exceeded, device functionality should not be assumed, damage may occur and reliability may be affected.

1. Package power dissipation on one-square inch pad, two-ounce copper board.

RECOMMENDED OPERATING CONDITIONS

| Symbol | Parameter | Min | Max | Unit |
|----------|-------------------------------|-----|-----|------------------|
| V_{IN} | Input Voltage | 1.8 | 5.5 | V |
| T_A | Ambient Operating Temperature | -40 | +85 | $^\circ\text{C}$ |

Functional operation above the stresses listed in the Recommended Operating Ranges is not implied. Extended exposure to stresses beyond the Recommended Operating Ranges limits may affect device reliability.

FPF2193, FPF2194, FPF2195

ELECTRICAL CHARACTERISTICS ($V_{IN} = 1.8$ to 5.5 V, $T_A = -40$ to $+85^\circ\text{C}$ unless otherwise noted. Typical values are at $V_{IN} = 3.3$ V and $T_A = 25^\circ\text{C}$.)

| Symbol | Parameter | Conditions | Min | Typ | Max | Unit | |
|------------------------|---|---|------------------|------|------|------------------|---------------|
| BASIC OPERATION | | | | | | | |
| V_{IN} | Operating Voltage | | 1.8 | – | 5.5 | V | |
| I_Q | Quiescent Current | $I_{OUT} = 0$ mA, $V_{ON} = V_{IN}$ | $V_{IN} = 1.8$ V | – | 70 | – | μA |
| | | | $V_{IN} = 3.3$ V | – | 75 | – | |
| | | | $V_{IN} = 5.5$ V | – | 80 | – | |
| R_{ON} | On Resistance | $T_A = 25^\circ\text{C}$, $I_{OUT} = 200$ mA | – | 55 | 80 | $\text{m}\Omega$ | |
| | | $T_A = -40$ to 85°C , $I_{OUT} = 200$ mA | – | – | 135 | | |
| V_{IH} | On Input Logic High Voltage ON | $V_{IN} = 1.8$ V | 0.8 | – | – | V | |
| | | $V_{IN} = 5.5$ V | 1.4 | – | – | | |
| V_{IL} | On Input Logic Low Voltage | $V_{IN} = 1.8$ V | – | – | 0.5 | V | |
| | | $V_{IN} = 5.5$ V | – | – | 1.0 | | |
| I_{IN} | On Input Leakage | $V_{ON} = V_{IN}$ or GND | –1 | 0 | 1 | μA | |
| V_{IN_SD} | V_{IN} Shutdown Current | $V_{ON} = 0$ V, $V_{IN} = 5.5$ V, $V_{OUT} = \text{Short to GND}$ | –2 | – | 2 | μA | |
| V_{FLB_L} | FLAGB Output Logic Low Voltage | $V_{IN} = 5$ V, $I_{SINK} = 10$ mA | – | 0.05 | 0.20 | V | |
| | | $V_{IN} = 1.8$ V, $I_{SINK} = 10$ mA | – | 0.12 | 0.30 | | |
| I_{FLB_H} | FLAGB Output Logic High Leakage Current | $V_{IN} = 5$ V, Switch ON | – | – | 1 | μA | |

REVERSE BLOCK

| | | | | | | |
|-----------------|----------------------------|---|----|---|---|---------------|
| I_{SDT} | V_{OUT} Shutdown Current | $V_{ON} = 0$ V, $V_{OUT} = 5.5$ V, $V_{IN} = \text{Short-to-GND}$ | –2 | – | 2 | μA |
| $V_{breakdown}$ | Reverse Breakdown Voltage | $V_{IN} = V_{ON} = 0$ V, $I_{OUT} = 200$ μA | – | 9 | – | V |

PROTECTIONS

| | | | | | | |
|------------------|----------------------------------|--|------|------|------|------------------|
| I_{LIM} | Current Limit | $V_{IN} = 3.3$ V, $V_{OUT} = 3.0$ V, $R_{SET} = 690$ Ω | 600 | 800 | 1000 | mA |
| | Current Limit for FPF2195BUCX | $V_{IN} = 4.5$ V, $V_{OUT} = 4.2$ V, $R_{SET} = 15.8$ k Ω | 35 | 45 | 60 | mA |
| $I_{LIM(MIN)}$ | Minimum Current Limit | $V_{IN} = 3.3$ V, $V_{OUT} = 3.0$ V, $R_{SET} = 5516$ Ω | – | 100 | – | mA |
| T_{SD} | Thermal Shutdown | Shutdown Threshold | – | 140 | – | $^\circ\text{C}$ |
| | | Return from Shutdown | – | 130 | – | |
| | | Hysteresis | – | 10 | – | |
| V_{UVLO} | Under-Voltage Lockout | V_{IN} Increasing | 1.55 | 1.65 | 1.75 | V |
| V_{UVLO_HYST} | Under-Voltage Lockout Hysteresis | | – | 50 | – | mV |

DYNAMIC

| | | | | | | |
|-------------|-----------------------------|---|-----|-----|-----|---------------|
| t_{dON} | Delay On Time | $R_L = 500$ Ω , $C_L = 0.1$ μF | – | 20 | – | μs |
| t_R | V_{OUT} Rise Time | $R_L = 500$ Ω , $C_L = 0.1$ μF | – | 20 | – | μs |
| t_{ON} | Turn-On Time | $R_L = 500$ Ω , $C_L = 0.1$ μF | – | 40 | – | μs |
| t_{dOFF} | Delay Off Time | $R_L = 500$ Ω , $C_L = 0.1$ μF | – | 15 | – | μs |
| t_F | V_{OUT} Fall Time | $R_L = 500$ Ω , $C_L = 0.1$ μF | – | 110 | – | μs |
| t_{OFF} | Turn-Off Time | $R_L = 500$ Ω , $C_L = 0.1$ μF | – | 125 | – | μs |
| t_{BLANK} | Over-Current Blanking Time | FPF2193, FPF2194 | 15 | 30 | 60 | ms |
| t_{RSTRT} | Auto-Restart | FPF2193 Only | 225 | 450 | 900 | ms |
| t_{SC} | Short-Circuit Response Time | $V_{IN} = V_{OUT} = 3.3$ V, Moderate Over-Current Condition | – | 5 | – | μs |
| | | $V_{IN} = V_{OUT} = 3.3$ V, Hard Short | – | 30 | – | ns |

Product parametric performance is indicated in the Electrical Characteristics for the listed test conditions, unless otherwise noted. Product performance may not be indicated by the Electrical Characteristics if operated under different conditions.

TYPICAL PERFORMANCE CHARACTERISTICS

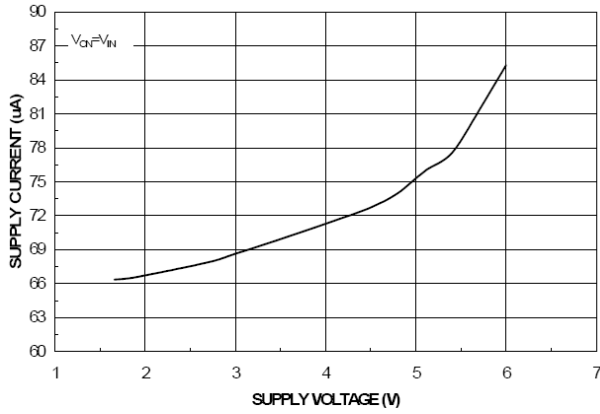

Figure 5. Quiescent Current vs. Input Voltage

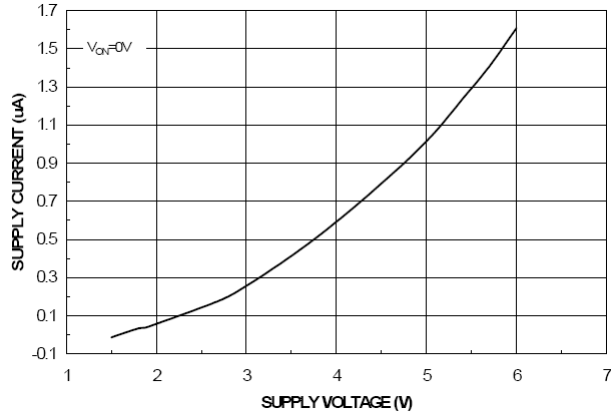

Figure 6. Quiescent Current vs. Input Voltage

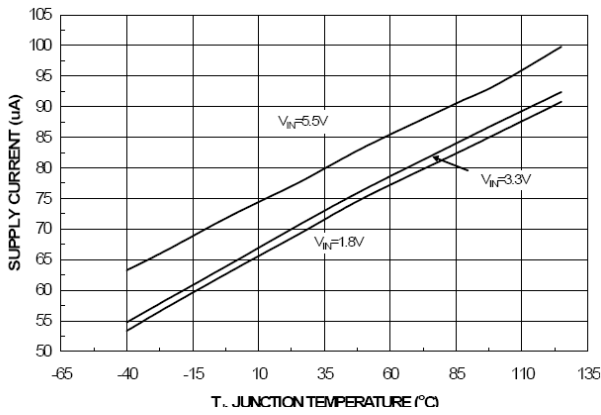

Figure 7. Quiescent Current vs. Temperature

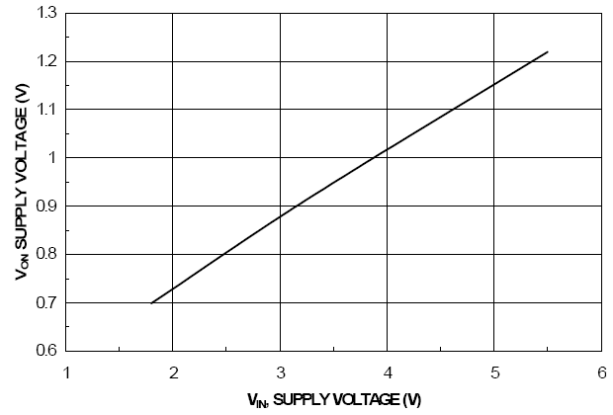

Figure 8. V_{ON} High Voltage vs. Input Voltage

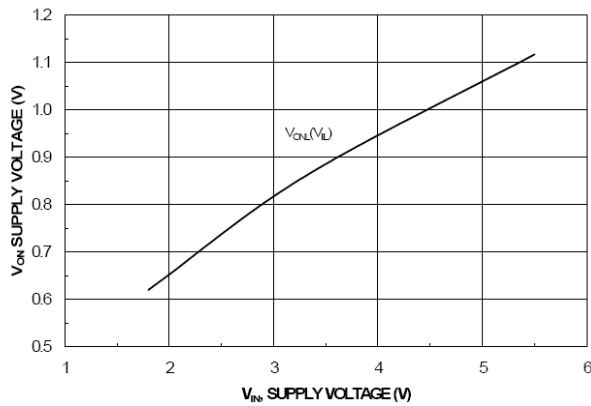

Figure 9. V_{ON} Low Voltage vs. Input Voltage

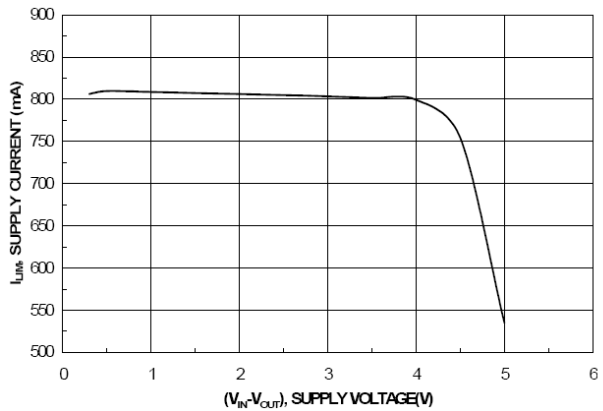

Figure 10. Current Limit vs. Output Voltage

TYPICAL PERFORMANCE CHARACTERISTICS (Continued)

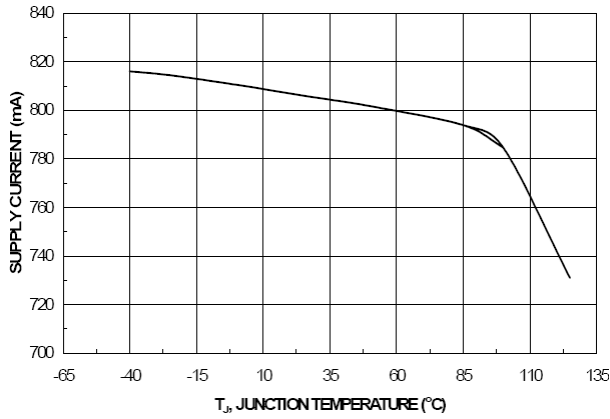

Figure 11. Current Limit vs. Temperature

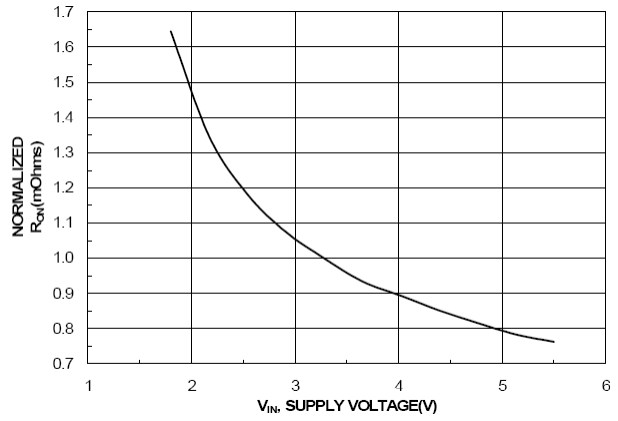

Figure 12. R_{ON} vs. V_{IN}

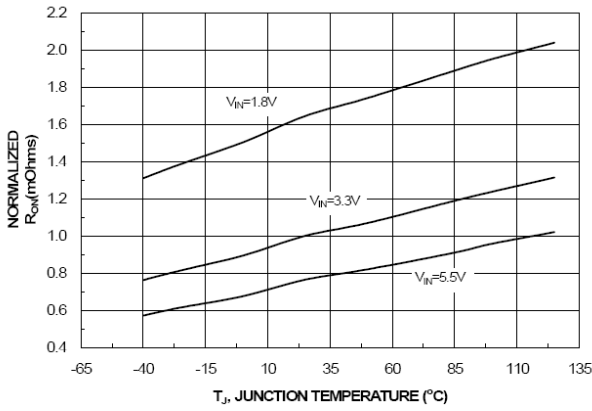

Figure 13. R_{ON} vs. Temperature

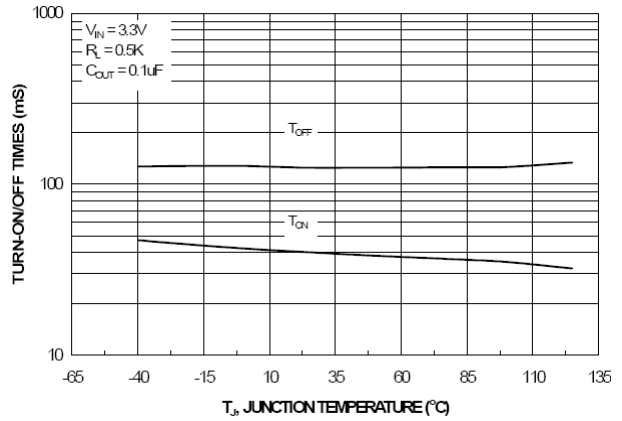

Figure 14. t_{ON} / t_{OFF} vs. Temperature

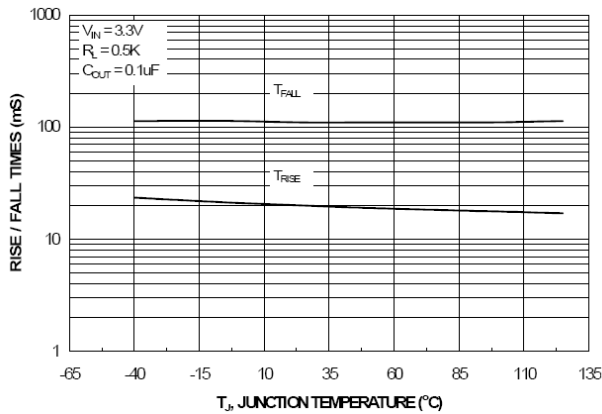

Figure 15. t_{RISE} / t_{FALL} vs. Temperature

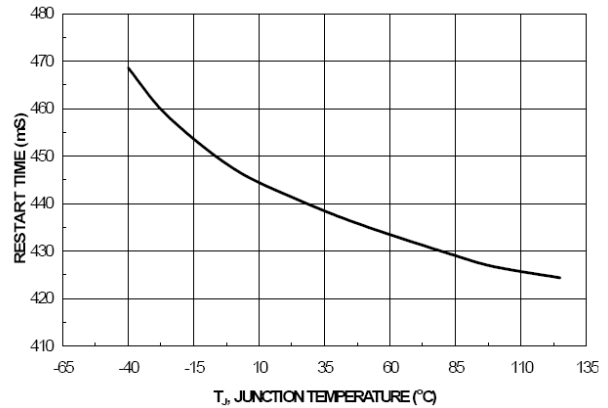

Figure 16. t_{RSTRT} vs. Temperature

TYPICAL PERFORMANCE CHARACTERISTICS (Continued)

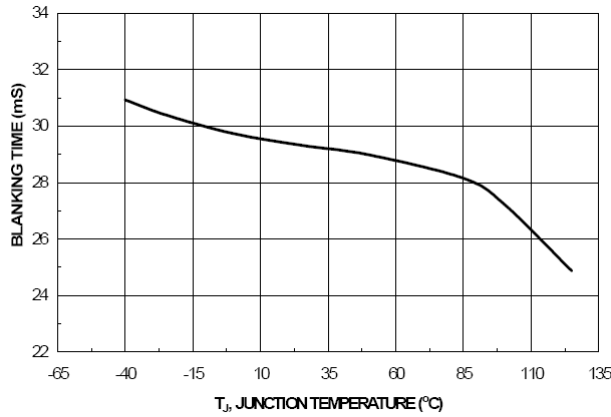

Figure 17. t_{BLANK} vs. Temperature

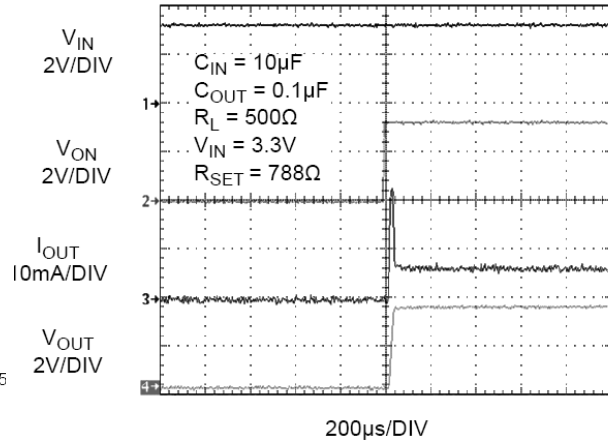

Figure 18. t_{ON} Response

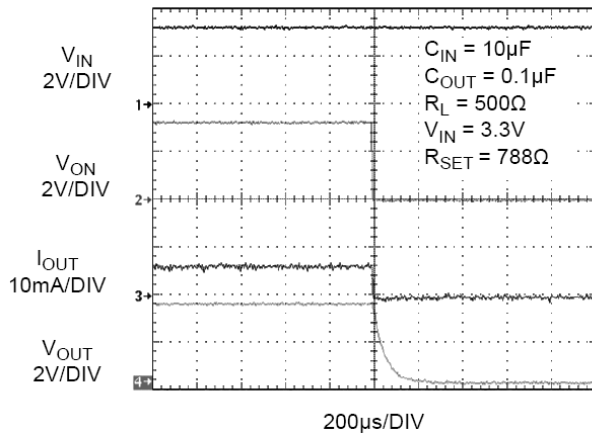

Figure 19. t_{OFF} Response

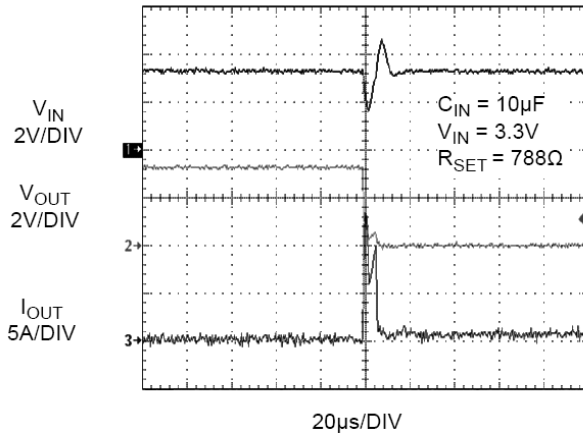

Figure 20. Short-Circuit Response Time (Output Shorted to GND)

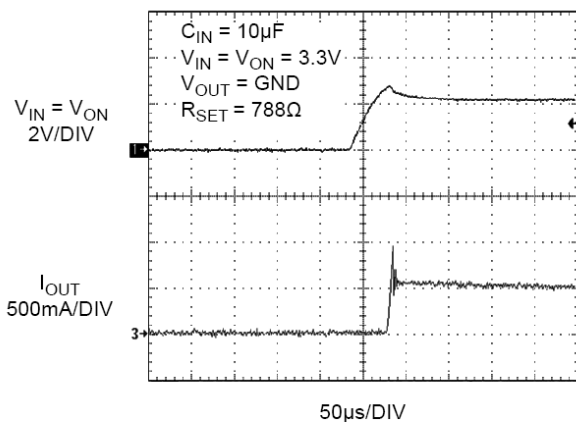

Figure 21. Current Limit Response Time (Switch is Powered into a Short)

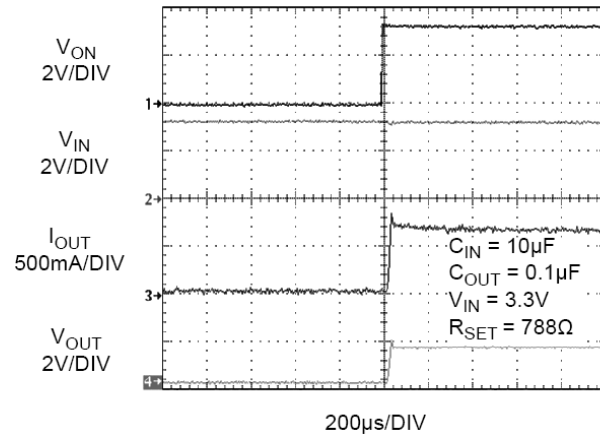

Figure 22. Current Limit Response Time (Output is Loaded by 2.2 Ω , $C_{OUT} = 0.1 \mu F$)

TYPICAL PERFORMANCE CHARACTERISTICS (Continued)

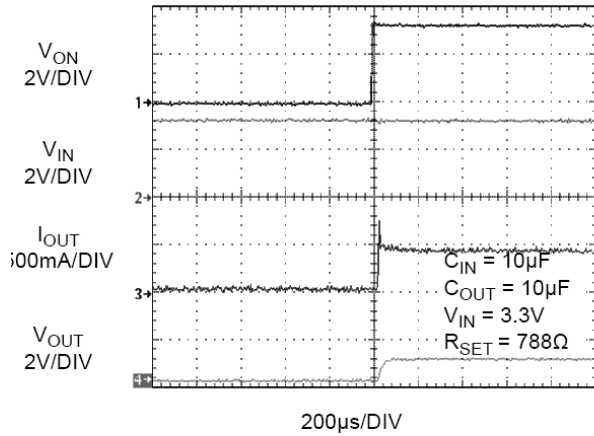

Figure 23. Current Limit Response Time (Output is Loaded by 2.2 Ω , C_{OUT} = 10 µF)

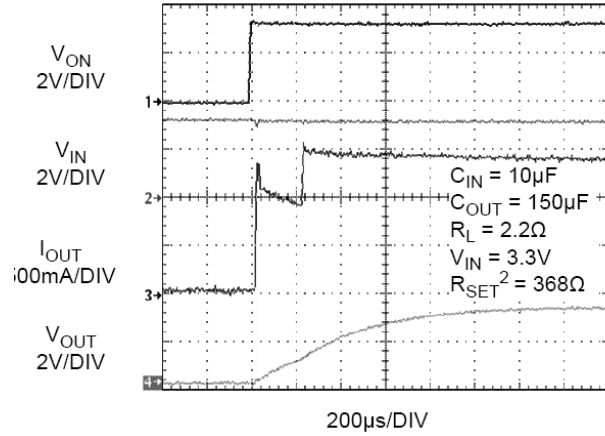

Figure 24. Short-Circuit Detection Function (Note 2)

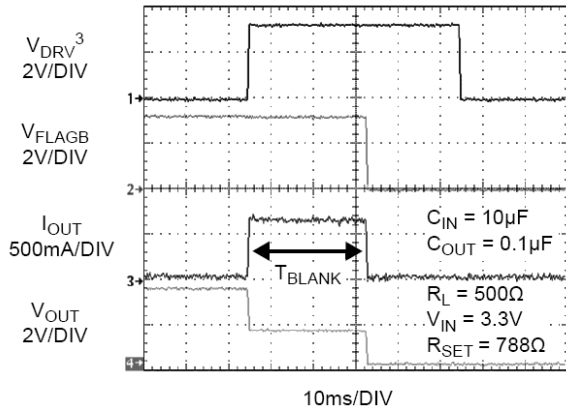

Figure 25. t_{BLANK} vs. Response (Note 3)

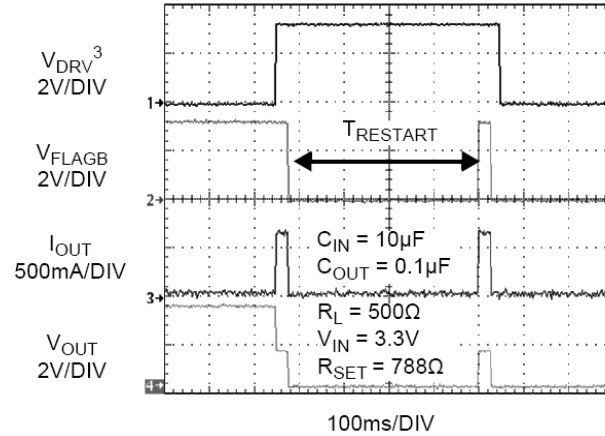

Figure 26. t_{RESTART} vs. Response (Note 3)

NOTE:

2. When the output voltage is below V_{SCTH} = 1.1 V, the current limit value is set at 62.5% of the current limit value.
3. V_{DRV} signal forces the device to go into over-current condition by loading.

FUNCTIONAL DESCRIPTION

The FPF2193, FPF2194, and FPF2195 are current-limited switches that protect systems and loads that can be damaged or disrupted by the application of high currents. The core of each device is a 55 mΩ P-channel MOSFET and a controller capable of functioning over the wide input operating range of 1.8 – 5.5 V. The controller protects against system malfunctions through current limiting, under-voltage lockout, and thermal shutdown. The current limit is adjustable from 100 mA (45 mA for FPF2195BUCX) to 1.5 A through the selection of an external resistor.

On/Off Control

The ON pin controls the state of the switch. When ON is HIGH, the switch is in ON state. Activating ON continuously holds the switch in the ON state so long as there is no fault. For all versions, an under-voltage on V_{IN} or a junction temperature in excess of 140°C overrides the ON control to turn off the switch. In addition, excessive currents cause the switch to turn off in the FPF2193 and FPF2194. The FPF2193 has an auto-restart feature that automatically turns the switch on again after 450 ms. For the FPF2194, the ON pin must be toggled to turn the switch on again. The FPF2195 does not turn off in response to an over-current condition, but remains operating in constant-current mode as long as ON is active and the thermal shutdown or under-voltage lockout have not activated.

Fault Reporting

Upon the detection of an over-current, input under-voltage, or over-temperature condition, FLAGB signals the fault mode by activating LOW. For the FPF2193 and FPF2194, the FLAGB goes LOW at the end of the blanking time, while FLAGB goes LOW immediately for the FPF2195. FLAGB remains LOW through the auto-restart time for the FPF2195. For the FPF2194, FLAGB is latched LOW and ON must be toggled to release it. With the FPF2195, FLAGB is LOW during the faults and immediately returns HIGH at the end of the fault condition. FLAGB is an open-drain MOSFET that requires a pull-up resistor between V_{IN} and FLAGB. During shutdown, the pull-down on FLAGB is disabled to reduce current draw from the supply.

Current Limiting

The current limit ensures that the current through the switch doesn't exceed a maximum value, while not limiting at less than a minimum value. The current at which the parts limit is adjustable through the selection of an external resistor connected to I_{SET} . Information for selecting the resistor is found in the Application Information section. The FPF2193 and FPF2194 have a blanking time of 30 ms, nominally, during which the switch acts as a constant current source. At the end of the blanking time, the switch is turned off.

The FPF2195 has no current limit blanking period, so it remains in a constant current state until the ON pin is deactivated or the thermal shutdown turns off the switch.

For preventing the switch from large power dissipation during heavy load, a short-circuit detection feature is introduced. Short-circuit condition is detected by, observing the output voltage. The switch is put into short-circuit current-limiting mode if the switch is loaded with a heavy load. When the output voltage drops below V_{SCTH} , the short-circuit detection threshold voltage, the current limit value is re-conditioned and the short-circuit current-limit value is decreased to 62.5% of the current limit value. This keeps the power dissipation of the part below a certain limit even at dead-short conditions at 5.5 V input voltage. The V_{SCTH} value is set to be 1 V. At around 1.1 V of output voltage, the switch is removed from short-circuit current-limiting mode and the current limit is set to the current limit value.

Under-Voltage Lockout (UVLO)

The under-voltage lockout turns the switch off if the input voltage drops below the under-voltage lockout threshold. With the ON pin active, the input voltage rising above the under-voltage lockout threshold causes a controlled turn-on of the switch, which limits current over shoot.

Thermal Shutdown

The thermal shutdown protects the die from internally or externally generated excessive temperatures. During an over-temperature condition, FLAGB is activated and the switch is turned off. The switch automatically turns on again if temperature of the die drops below the threshold temperature.

Reverse-Current Blocking

The entire FPF2193/94/95 family has a reverse current blocking feature that protects the input source against current flow from output to input. For a standard USB power design, this is an important feature to protect the USB host from being damaged due to reverse current flow on V_{BUS} .

When the load switch is OFF, no current flows from the output to the input. If the switch is turned on and the output voltage is greater than input voltage, this feature is activated and turns off the switch. This prevents any current flow from output to input. The reverse-current blocking feature is deactivated if the $V_{OUT} - V_{IN}$ is smaller than a typically 50 mV threshold. During this time, some current (50 mV/ R_{ON}) flows from the output to input until input voltage becomes greater than output voltage. FLAGB operation is independent of the reverse-current blocking and does not report a fault condition if this feature is activated.

FPF2193, FPF2194, FPF2195

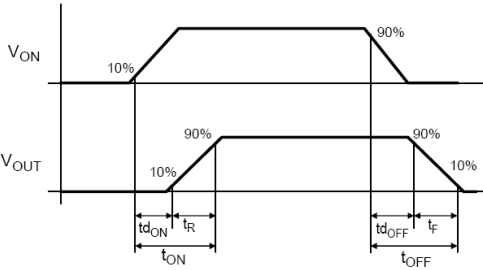

Figure 27. Timing Diagram

where:

- t_{dON} = Delay On Time
- t_R = V_{OUT} Rise Time
- t_{ON} = Turn-On Time
- t_{dOFF} = Delay Off Time
- t_F = V_{OUT} Fall Time
- t_{OFF} = Turn-Off Time

APPLICATION INFORMATION

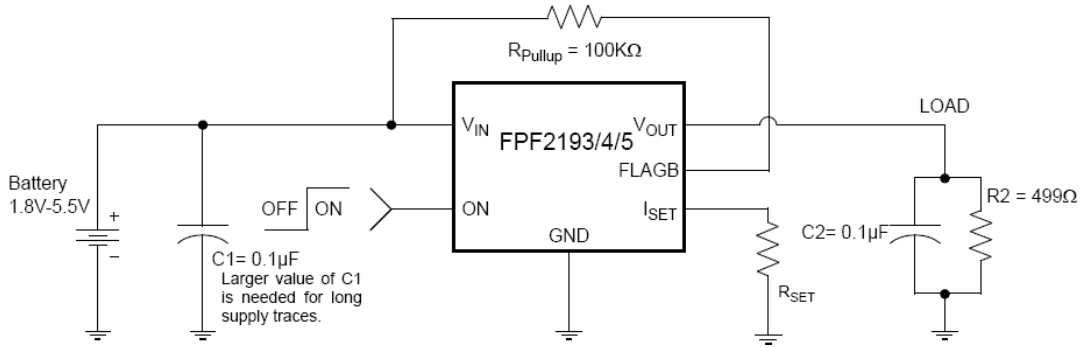

Figure 28. Typical Application

Setting Current Limit

The FPF2193, FPF2194, and FPF2195 current limit is set with an external resistor connected between ISET and GND. This resistor is selected using the following equation:

$$R_{SET} = \frac{551.6}{I_{LIM}} \quad (\text{eq. 1})$$

RSET is in Ω and ISET is in Amps.

Table 1 can also be used to select RSET. A typical application would be the 500 mA current required by a single USB port. Using Table 1, an appropriate selection for the RSET resistor would be 788 Ω. This ensures that the port load could draw 525 mA, but not more than 875 mA. Likewise for a dual-port system; an RSET of 368 Ω always delivers at least 1125 mA and never more than 1875 mA.

Table 1. CURRENT LIMIT VARIOUS RSET VALUES

| RSET (Ω) | Min. Current Limit (mA) | Typ. Current Limit (mA) | Max. Current Limit (mA) |
|----------------|-------------------------|-------------------------|-------------------------|
| 368 | 1125 | 1500 | 1875 |
| 441 | 928 | 1250 | 1562 |
| 552 | 750 | 1000 | 1250 |
| 613 | 675 | 900 | 1125 |
| 690 | 600 | 800 | 1000 |
| 788 | 525 | 700 | 875 |
| 919 | 450 | 600 | 750 |
| 1103 | 375 | 500 | 625 |
| 1226 | 338 | 450 | 563 |
| 1379 | 300 | 400 | 500 |
| 1576 | 263 | 350 | 438 |
| 1839 | 225 | 300 | 375 |
| 2206 | 188 | 250 | 313 |
| 2758 | 150 | 200 | 250 |
| 3677 | 113 | 150 | 188 |
| 5516 | 75 | 100 | 125 |
| 15800 (Note 4) | 35 | 45 | 60 |

4. FPF2195BUCX only.

Input Capacitor

To limit the voltage drop on the input supply caused by transient inrush currents when the switch is turned on into a discharged load capacitor or a short-circuit, a capacitor needs to be placed between VIN and GND. A 0.1 μF ceramic capacitor, CIN, placed close to the pins is usually sufficient. Higher values of CIN can be used to further reduce the voltage drop.

Output Capacitor

A 0.1 μF capacitor, COUT, should be placed between VOUT and GND. This capacitor prevents parasitic board inductances from forcing VOUT below GND when the switch turns off. For the FPF2193 and FPF2194, the total output capacitance needs to be kept below a maximum value, COUT(max), to prevent the part from registering an over-current condition and turning off the switch. The maximum output capacitance can be determined from the following formula:

$$C_{OUT(max)} = \frac{I_{LIM(max)} \times t_{BLANK(min)}}{V_{IN}} \quad (\text{eq. 2})$$

Power Dissipation

During normal operation as a switch, the power dissipated depends upon the level at which the current limit is set. The maximum allowed setting for the current limit is 1.5 A and results in a power dissipation of :

$$C_{OUT(max)} = \frac{I_{LIM(max)} \times t_{BLANK(min)}}{V_{IN}} \quad (\text{eq. 3})$$

If the part goes into current limit, the maximum power dissipation occurs when the output is shorted to ground. For the FPF2193, the power dissipation scales by the auto-restart time, tRSTRT, and the over-current blanking time, tBLANK, so that the maximum power dissipated is:

$$P(max) = \frac{t_{BLANK}}{t_{BLANK} + t_{RSTRT}} \times V_{IN(max)} \times I_{LIM(max)} = \frac{30}{30 + 450} \times 5.5 \times 1.5 = 515.6 \text{ mW} \quad (\text{eq. 4})$$

FPF2193, FPF2194, FPF2195

This is more power than the package can dissipate, but the thermal shutdown of the part activates to protect the part from damage due to excessive heating. When using the FPF2194, attention must be given to the manual resetting of the part. The junction temperature is only able to increase to the thermal shutdown threshold. Once this temperature has been reached, toggling ON does not turn the switch on until the junction temperature drops. For the FPF2195, a short on the output causes the part to operate in a constant-current state, dissipating a worst-case power of:

$$\begin{aligned}
 P(\text{max}) &= V_{\text{IN}}(\text{max}) \times I_{\text{LIM}}(\text{max}) \\
 &= 5.5 \times 1.5 = 8.25 \text{ W}
 \end{aligned}
 \tag{eq. 5}$$

This large amount of power activates the thermal shutdown and the part cycles in and out of thermal shutdown as long as the ON pin is active and the short is present.

Board Layout

For best performance, all traces should be as short as possible. To be most effective, the input and output capacitors should be placed close to the device to minimize the effects that parasitic trace inductances may have on normal and short-circuit operation. Using wide traces for V_{IN} , V_{OUT} , and GND help to minimize parasitic electrical effects along with minimizing the case-to-ambient thermal impedance.

ORDERING INFORMATION

| Device Order Number | Current Limit (mA) | Current Limit Blanking Time (ms) | Auto-Restart Time (ms) | ON Pin Activity | Top Mark | Package Type | Shipping [†] |
|---------------------|--------------------|----------------------------------|------------------------|-----------------|----------|--|-----------------------|
| FPF2193 | 100 – 1500 | 15/30/60 | 225/450/900 | Active HIGH | S6 | WLCSP6 1.48x0.98x0.582 (Pb-Free) | 3000 / Tape & Reel |
| FPF2194 | | 15/30/60 | NA | | S7 | | 3000 / Tape & Reel |
| FPF2195 | | 0 | NA | | S9 | | 3000 / Tape & Reel |
| FPF2195BUCX | 45 – 1500 | 0S | NA | | SY | | 3000 / Tape & Reel |

[†]For information on tape and reel specifications, including part orientation and tape sizes, please refer to our Tape and Reel Packaging Specifications Brochure, BRD8011/D.



WLCSP6 1.48x0.98x0.582
CASE 567RN
ISSUE O

DATE 30 NOV 2016

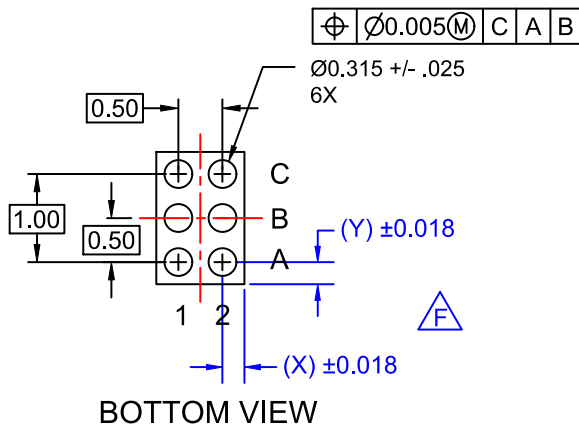
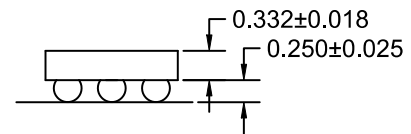
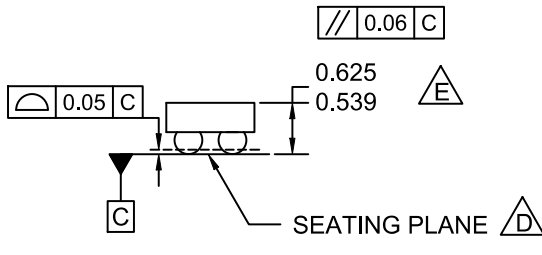
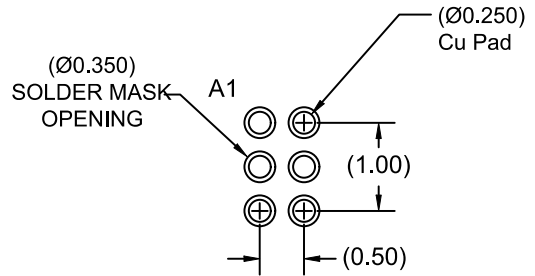
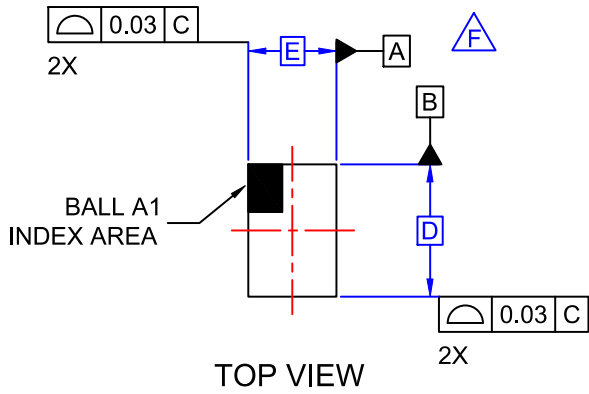

NOTES:

- A. NO JEDEC REGISTRATION APPLIES.
- B. DIMENSIONS ARE IN MILLIMETERS.
- C. DIMENSIONS AND TOLERANCE PER ASMEY14.5M, 1994.
- D** DATUM C IS DEFINED BY THE SPHERICAL CROWNS OF THE BALLS.
- E** PACKAGE NOMINAL HEIGHT IS 582 MICRONS ±43 MICRONS (539-625 MICRONS).
- F** FOR DIMENSIONS D, E, X, AND Y SEE PRODUCT DATASHEET.

| | | |
|-------------------------|-------------------------------|--|
| DOCUMENT NUMBER: | 98AON16581G | Electronic versions are uncontrolled except when accessed directly from the Document Repository. Printed versions are uncontrolled except when stamped "CONTROLLED COPY" in red. |
| DESCRIPTION: | WLCSP6 1.48x0.98x0.582 | PAGE 1 OF 1 |

ON Semiconductor and are trademarks of Semiconductor Components Industries, LLC dba ON Semiconductor or its subsidiaries in the United States and/or other countries. ON Semiconductor reserves the right to make changes without further notice to any products herein. ON Semiconductor makes no warranty, representation or guarantee regarding the suitability of its products for any particular purpose, nor does ON Semiconductor assume any liability arising out of the application or use of any product or circuit, and specifically disclaims any and all liability, including without limitation special, consequential or incidental damages. ON Semiconductor does not convey any license under its patent rights nor the rights of others.

onsemi, **Onsemi**, and other names, marks, and brands are registered and/or common law trademarks of Semiconductor Components Industries, LLC dba "**onsemi**" or its affiliates and/or subsidiaries in the United States and/or other countries. **onsemi** owns the rights to a number of patents, trademarks, copyrights, trade secrets, and other intellectual property. A listing of **onsemi**'s product/patent coverage may be accessed at www.onsemi.com/site/pdf/Patent-Marking.pdf. **onsemi** reserves the right to make changes at any time to any products or information herein, without notice. The information herein is provided "as-is" and **onsemi** makes no warranty, representation or guarantee regarding the accuracy of the information, product features, availability, functionality, or suitability of its products for any particular purpose, nor does **onsemi** assume any liability arising out of the application or use of any product or circuit, and specifically disclaims any and all liability, including without limitation special, consequential or incidental damages. Buyer is responsible for its products and applications using **onsemi** products, including compliance with all laws, regulations and safety requirements or standards, regardless of any support or applications information provided by **onsemi**. "Typical" parameters which may be provided in **onsemi** data sheets and/or specifications can and do vary in different applications and actual performance may vary over time. All operating parameters, including "Typicals" must be validated for each customer application by customer's technical experts. **onsemi** does not convey any license under any of its intellectual property rights nor the rights of others. **onsemi** products are not designed, intended, or authorized for use as a critical component in life support systems or any FDA Class 3 medical devices or medical devices with a same or similar classification in a foreign jurisdiction or any devices intended for implantation in the human body. Should Buyer purchase or use **onsemi** products for any such unintended or unauthorized application, Buyer shall indemnify and hold **onsemi** and its officers, employees, subsidiaries, affiliates, and distributors harmless against all claims, costs, damages, and expenses, and reasonable attorney fees arising out of, directly or indirectly, any claim of personal injury or death associated with such unintended or unauthorized use, even if such claim alleges that **onsemi** was negligent regarding the design or manufacture of the part. **onsemi** is an Equal Opportunity/Affirmative Action Employer. This literature is subject to all applicable copyright laws and is not for resale in any manner.

PUBLICATION ORDERING INFORMATION

LITERATURE FULFILLMENT:

Email Requests to: orderlit@onsemi.com

onsemi Website: www.onsemi.com

TECHNICAL SUPPORT

North American Technical Support:

Voice Mail: 1 800-282-9855 Toll Free USA/Canada

Phone: 011 421 33 790 2910

Europe, Middle East and Africa Technical Support:

Phone: 00421 33 790 2910

For additional information, please contact your local Sales Representative