

# Field Stop Trench IGBT

## 650 V, 75 A

### FGHL75T65MQD

Field stop 4th generation mid speed IGBT technology and Full current rated copak Diode technology.

#### Features

- Maximum Junction Temperature:  $T_J = 175^\circ\text{C}$
- Positive Temperature Co-efficient for Easy Parallel Operating
- High Current Capability
- Low Saturation Voltage:  $V_{CE(sat)} = 1.45\text{ V (Typ.) @ } I_C = 75\text{ A}$
- 100% of the Parts are Tested for  $I_{LM}$  (Note 2)
- Smooth & Optimized Switching
- Tight Parameter Distribution
- RoHS Compliant

#### Typical Applications

- Solar Inverter
- UPS, ESS
- PFC, Converters

#### MAXIMUM RATINGS

Parameter	Symbol	Value	Unit	
Collector-to-Emitter Voltage	$V_{CES}$	650	V	
Gate-to-Emitter Voltage	$V_{GES}$	$\pm 20$	V	
Transient Gate-to-Emitter Voltage	$V_{GES}$	$\pm 30$	V	
Collector Current (Note 1)	$I_C$	$T_C = 25^\circ\text{C}$	80	A
		$T_C = 100^\circ\text{C}$	75	
Pulsed Collector Current (Note 2)	$I_{LM}$	300	A	
Pulsed Collector Current (Note 3)	$I_{CM}$	300	A	
Diode Forward Current (Note 1)	$I_F$	$T_C = 25^\circ\text{C}$	80	A
		$T_C = 65^\circ\text{C}$	75	
Pulsed Diode Maximum Forward Current	$I_{FM(2)}$	300	A	
Non-Repetitive Forward Surge Current (Half-Sine Pulse, $t_p = 8.3\text{ ms}$ , $T_C = 25^\circ\text{C}$ ) (Half-Sine Pulse, $t_p = 8.3\text{ ms}$ , $T_C = 150^\circ\text{C}$ )	$I_{F,SM}$		255	A
			225	
Maximum Power Dissipation	$P_D$	$T_C = 25^\circ\text{C}$	375	W
		$T_C = 100^\circ\text{C}$	188	
Operating Junction and Storage Temperature Range	$T_J, T_{stg}$	-55 to +175	$^\circ\text{C}$	
Maximum Lead Temperature for Soldering Purposes (1/8" from case for 5 s)	$T_L$	260	$^\circ\text{C}$	

Stresses exceeding those listed in the Maximum Ratings table may damage the device. If any of these limits are exceeded, device functionality should not be assumed, damage may occur and reliability may be affected.

1. Value limit by bond wire
2.  $V_{CC} = 400\text{ V}$ ,  $V_{GE} = 15\text{ V}$ ,  $I_C = 300\text{ A}$ ,  $R_G = 14\ \Omega$ , Inductive Load, 100% Tested
3. Repetitive rating: Pulse width limited by max. junction temperature



ON Semiconductor®

[www.onsemi.com](http://www.onsemi.com)

$BV_{CES}$	$V_{CE(sat)}$ TYP	$I_C$ MAX
650 V	1.45 V	75 A

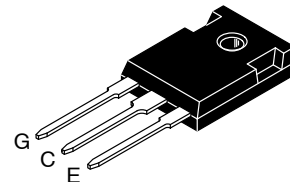
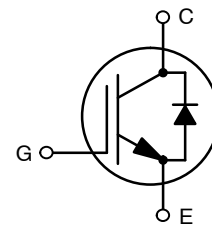

TO-247 LONG LEADS  
CASE 340CX

#### MARKING DIAGRAM

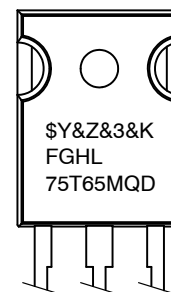

$\$Y$  = ON Semiconductor Logo  
 $\&Z$  = Assembly Plant Code  
 $\&3$  = 3-Digit Date Code  
 $\&K$  = 2-Digit Lot Traceability Code  
 FGHL75T65MQD = Specific Device Code

#### ORDERING INFORMATION

Device	Package	Shipping
FGHL75T65MQD	TO-247-3L	30 Units / Rail

# FGHL75T65MQD

**Table 1. THERMAL CHARACTERISTICS**

Parameter	Symbol	Value	Unit
Thermal Resistance Junction-to-Case, for IGBT	$R_{\theta JC}$	0.40	°C/W
Thermal Resistance Junction-to-Case, for Diode	$R_{\theta JC}$	0.6	
Thermal Resistance Junction-to-Ambient	$R_{\theta JA}$	40	

**Table 2. ELECTRICAL CHARACTERISTICS** ( $T_J = 25^\circ\text{C}$  unless otherwise specified)

Parameter	Test Conditions	Symbol	Min	Typ	Max	Unit
<b>OFF CHARACTERISTIC</b>						
Collector-emitter breakdown voltage, gate-emitter short-circuited	$V_{GE} = 0\text{ V}, I_C = 1\text{ mA}$	$BV_{CES}$	650	-	-	V
Temperature Coefficient of Breakdown Voltage	$V_{GE} = 0\text{ V}, I_C = 1\text{ mA}$	$\Delta BV_{CES} / \Delta T_J$	-	0.6	-	V/°C
Collector-emitter cut-off current, gate-emitter short-circuited	$V_{GE} = 0\text{ V}, V_{CE} = 650\text{ V}$	$I_{CES}$	-	-	250	μA
Gate leakage current, collector-emitter short-circuited	$V_{GE} = 20\text{ V}, V_{CE} = 0\text{ V}$	$I_{GES}$	-	-	±400	nA
<b>ON CHARACTERISTIC</b>						
Gate-emitter threshold voltage	$V_{GE} = V_{CE}, I_C = 75\text{ mA}$	$V_{GE(th)}$	3.0	4.5	6.0	V
Collector-emitter saturation voltage	$V_{GE} = 15\text{ V}, I_C = 75\text{ A}$ $V_{GE} = 15\text{ V}, I_C = 75\text{ A}, T_J = 175^\circ\text{C}$	$V_{CE(sat)}$	-	1.45 1.65	1.8 -	V
<b>DYNAMIC CHARACTERISTIC</b>						
Input capacitance	$V_{CE} = 30\text{ V}, V_{GE} = 0\text{ V}, f = 1\text{ MHz}$	$C_{ies}$	-	4913	-	pF
Output capacitance		$C_{oes}$	-	131	-	
Reverse transfer capacitance		$C_{res}$	-	15	-	
Gate charge total	$V_{CE} = 400\text{ V}, I_C = 75\text{ A}, V_{GE} = 15\text{ V}$	$Q_g$	-	145	-	nC
Gate-to-Emitter charge		$Q_{ge}$	-	25	-	
Gate-to-Collector charge		$Q_{gc}$	-	33	-	
<b>SWITCHING CHARACTERISTIC, INDUCTIVE LOAD</b>						
Turn-on delay time	$T_C = 25^\circ\text{C}$ $V_{CC} = 400\text{ V}, I_C = 37.5\text{ A}$ $R_G = 10\ \Omega$ $V_{GE} = 15\text{ V}$ Inductive Load	$t_{d(on)}$	-	29	-	ns
Rise time		$t_r$	-	29	-	
Turn-off delay time		$t_{d(off)}$	-	193	-	
Fall time		$t_f$	-	47	-	
Turn-on switching loss		$E_{on}$	-	0.75	-	mJ
Turn-off switching loss		$E_{off}$	-	0.48	-	
Total switching loss		$E_{ts}$	-	1.22	-	
Turn-on delay time	$T_C = 25^\circ\text{C}$ $V_{CC} = 400\text{ V}, I_C = 75\text{ A}$ $R_G = 10\ \Omega$ $V_{GE} = 15\text{ V}$ Inductive Load	$t_{d(on)}$	-	33	-	ns
Rise time		$t_r$	-	60	-	
Turn-off delay time		$t_{d(off)}$	-	176	-	
Fall time		$t_f$	-	76	-	
Turn-on switching loss		$E_{on}$	-	1.94	-	mJ
Turn-off switching loss		$E_{off}$	-	1.55	-	
Total switching loss		$E_{ts}$	-	3.49	-	

# FGHL75T65MQD

**Table 2. ELECTRICAL CHARACTERISTICS** ( $T_J = 25^\circ\text{C}$  unless otherwise specified) (continued)

Parameter	Test Conditions	Symbol	Min	Typ	Max	Unit
<b>SWITCHING CHARACTERISTIC, INDUCTIVE LOAD</b>						
Turn-on delay time	$T_C = 175^\circ\text{C}$ $V_{CC} = 400\text{ V}$ , $I_C = 37.5\text{ A}$ $R_G = 10\ \Omega$ $V_{GE} = 15\text{ V}$ Inductive Load	$t_{d(on)}$	–	27	–	ns
Rise time		$t_r$	–	31	–	
Turn-off delay time		$t_{d(off)}$	–	214	–	
Fall time		$t_f$	–	66	–	
Turn-on switching loss		$E_{on}$	–	1.49	–	mJ
Turn-off switching loss		$E_{off}$	–	0.72	–	
Total switching loss		$E_{ts}$	–	2.21	–	
Turn-on delay time	$T_C = 175^\circ\text{C}$ $V_{CC} = 400\text{ V}$ , $I_C = 75\text{ A}$ $R_G = 10\ \Omega$ $V_{GE} = 15\text{ V}$ Inductive Load	$t_{d(on)}$	–	31	–	ns
Rise time		$t_r$	–	61	–	
Turn-off delay time		$t_{d(off)}$	–	191	–	
Fall time		$t_f$	–	85	–	
Turn-on switching loss		$E_{on}$	–	3.23	–	mJ
Turn-off switching loss		$E_{off}$	–	1.90	–	
Total switching loss		$E_{ts}$	–	5.12	–	
<b>DIODE CHARACTERISTIC</b>						
Diode Forward Voltage	$I_F = 75\text{ A}$ , $T_C = 25^\circ\text{C}$ $I_F = 75\text{ A}$ , $T_C = 175^\circ\text{C}$	$V_{FM}$	– –	2.3 1.9	2.6 –	V
Reverse Recovery Energy	$I_F = 75\text{ A}$ , $di_F/dt = 200\text{ A}/\mu\text{s}$ , $T_C = 175^\circ\text{C}$	$E_{rec}$	–	49	–	$\mu\text{J}$
Diode Reverse Recovery Time	$I_F = 75\text{ A}$ , $di_F/dt = 200\text{ A}/\mu\text{s}$ , $T_C = 25^\circ\text{C}$ $I_F = 75\text{ A}$ , $di_F/dt = 200\text{ A}/\mu\text{s}$ , $T_C = 175^\circ\text{C}$	$T_{rr}$	–	36 204	–	ns
Diode Reverse Recovery Charge	$I_F = 75\text{ A}$ , $di_F/dt = 200\text{ A}/\mu\text{s}$ , $T_C = 25^\circ\text{C}$ $I_F = 75\text{ A}$ , $di_F/dt = 200\text{ A}/\mu\text{s}$ , $T_C = 175^\circ\text{C}$	$Q_{rr}$	–	51 990	–	nC

Product parametric performance is indicated in the Electrical Characteristics for the listed test conditions, unless otherwise noted. Product performance may not be indicated by the Electrical Characteristics if operated under different conditions.

# FGHL75T65MQD

## TYPICAL CHARACTERISTICS

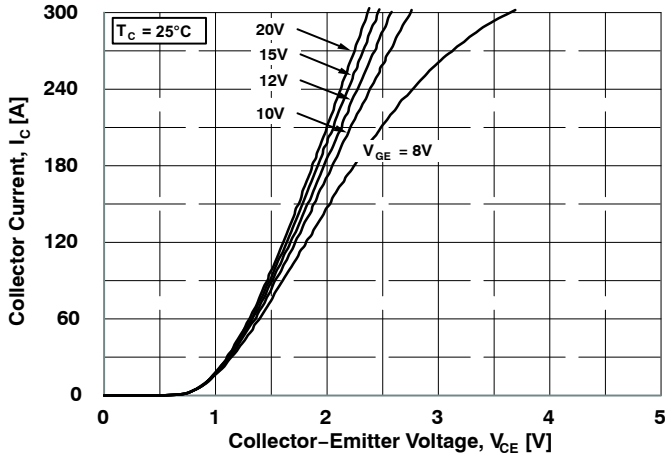

Figure 1. Typical Output Characteristics (25°C)

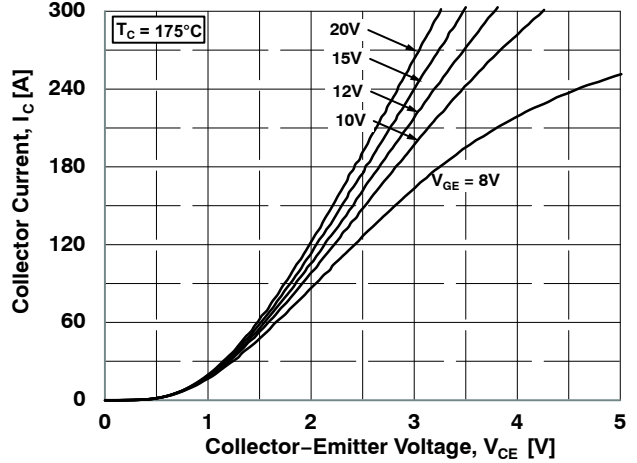

Figure 2. Typical Output Characteristics (175°C)

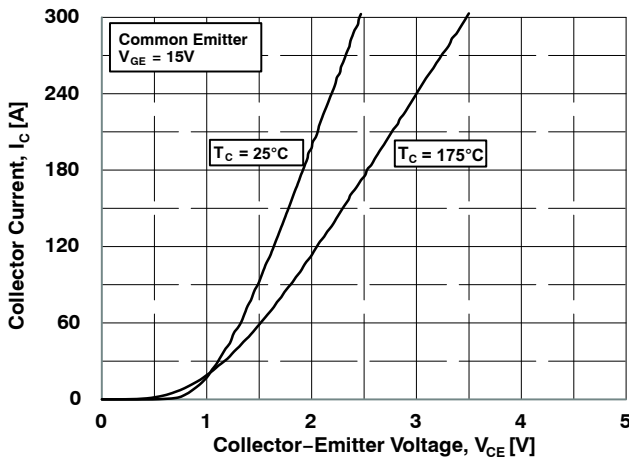

Figure 3. Typical Saturation Voltage Characteristics

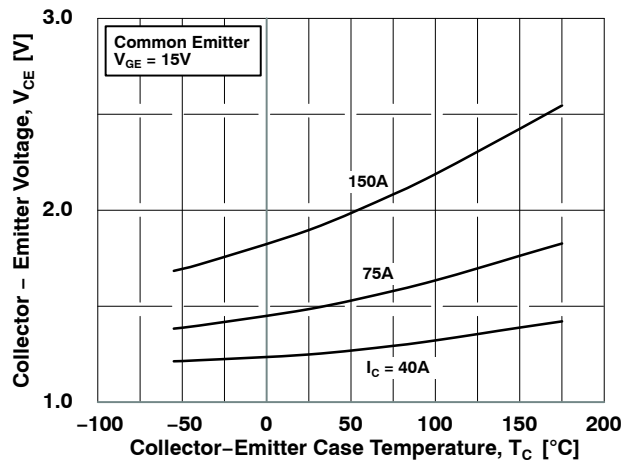

Figure 4. Saturation Voltage vs. Case Temperature at Variant Current Level

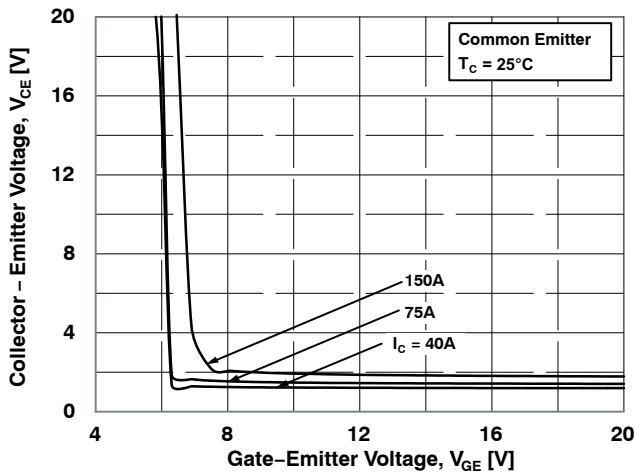

Figure 5. Saturation Voltage vs.  $V_{GE}$  (25°C)

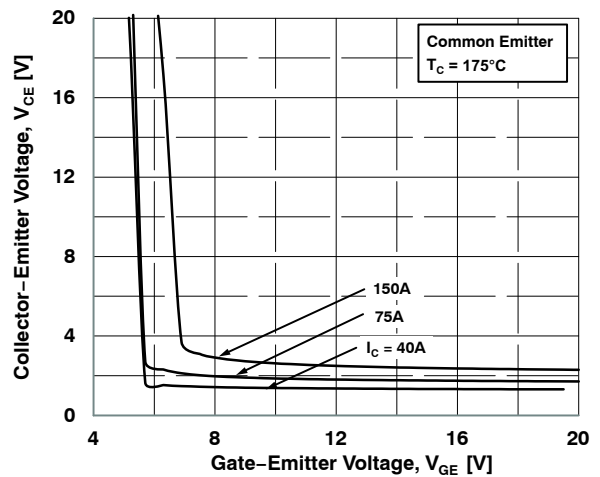

Figure 6. Saturation Voltage vs.  $V_{GE}$  (175°C)

# FGHL75T65MQD

## TYPICAL CHARACTERISTICS

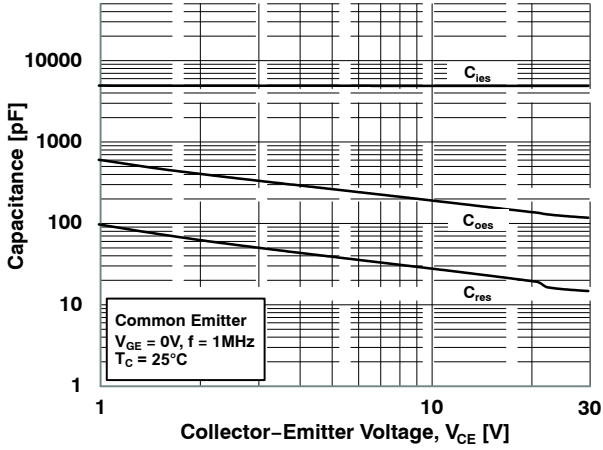

Figure 7. Capacitance Characteristics

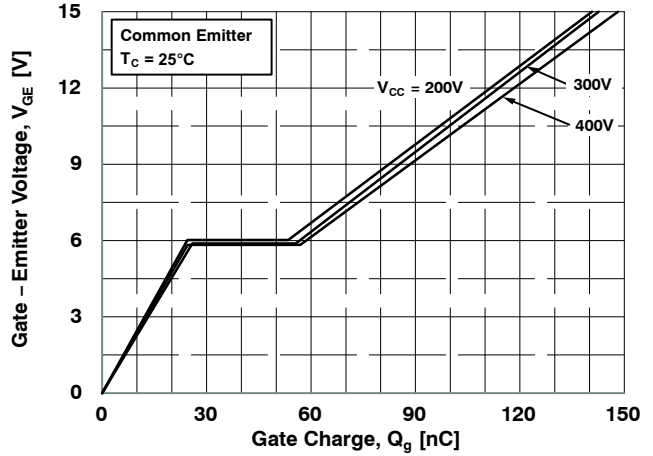

Figure 8. Gate Charge Characteristics

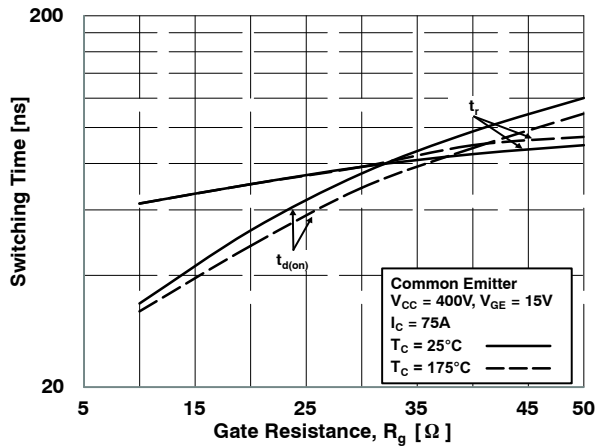

Figure 9. Turn-On Characteristics vs. Gate Resistance

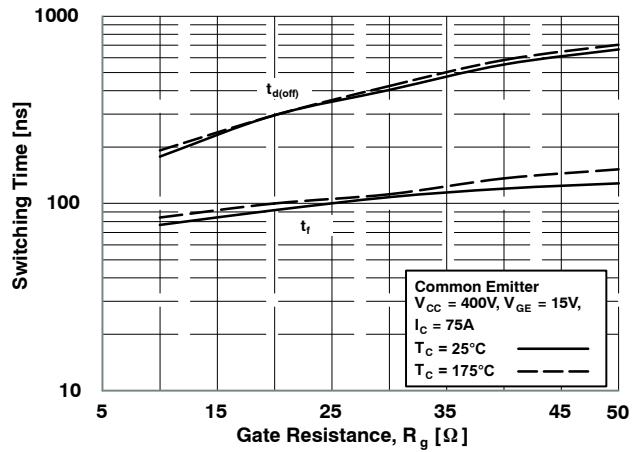

Figure 10. Turn-Off Characteristics vs. Gate Resistance

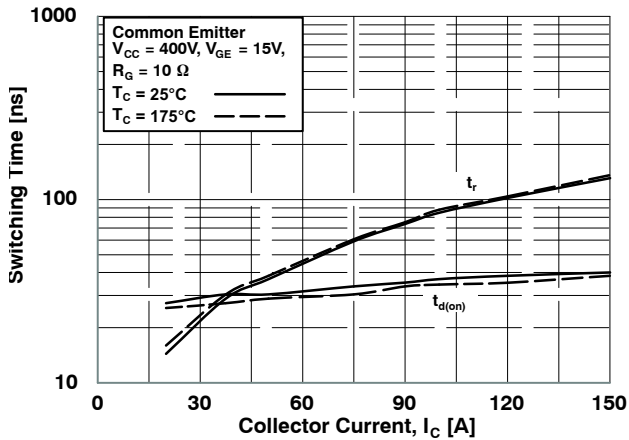

Figure 11. Turn-On Characteristics vs. Collector Current

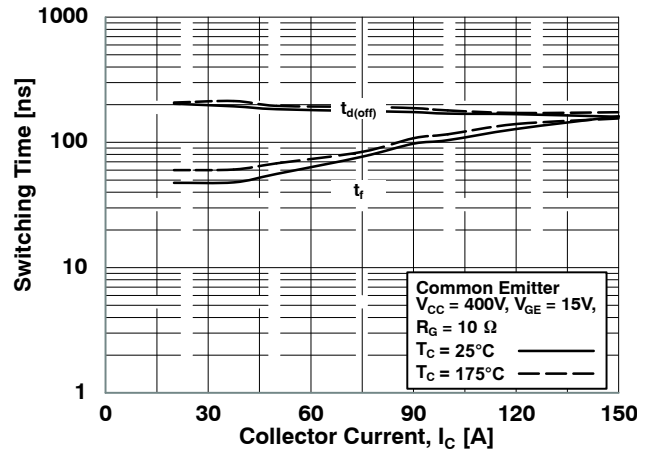

Figure 12. Turn-Off Characteristics vs. Collector Current

# FGHL75T65MQD

## TYPICAL CHARACTERISTICS

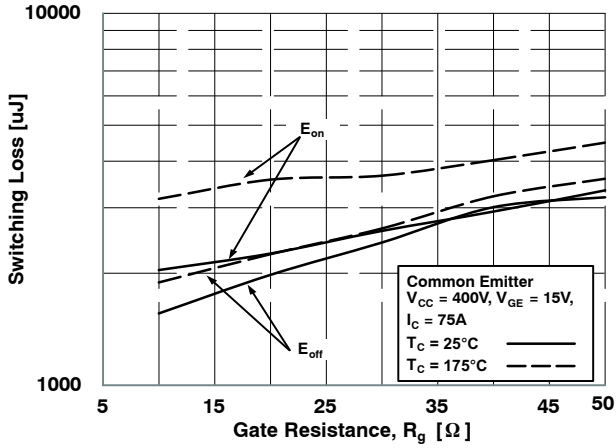

Figure 13. Switching Loss vs. Gate Resistance

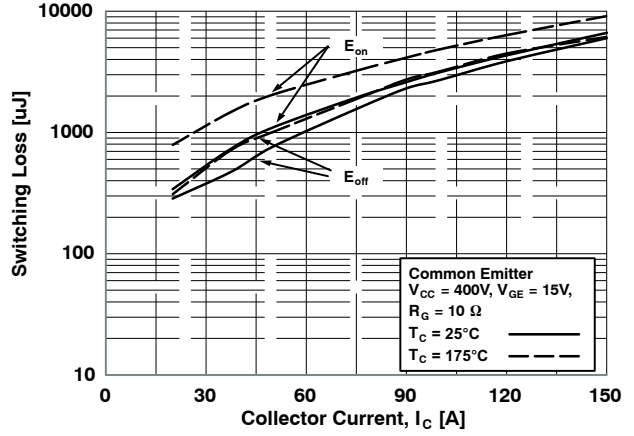

Figure 14. Switching Loss vs. Collector Current

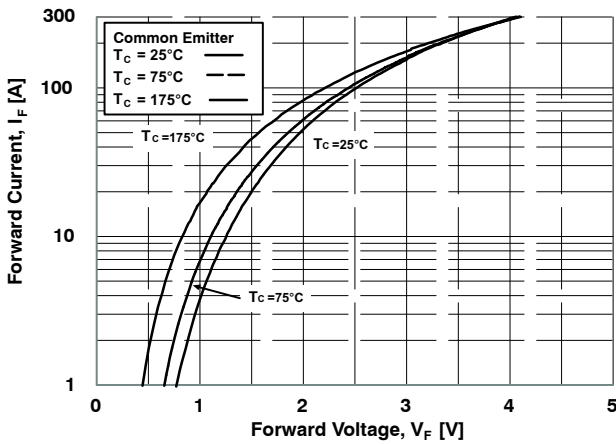

Figure 15. Forward Characteristics

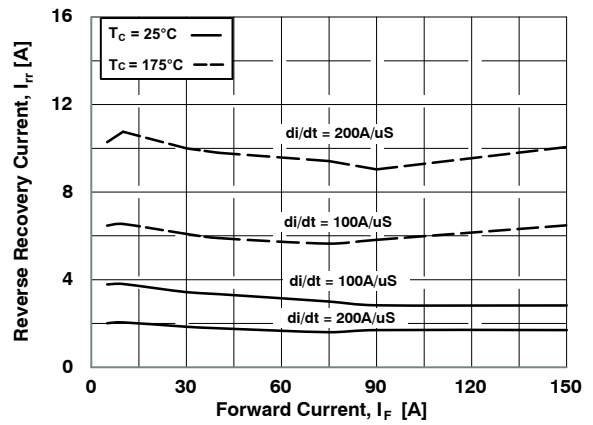

Figure 16. Reverse Recovery Current

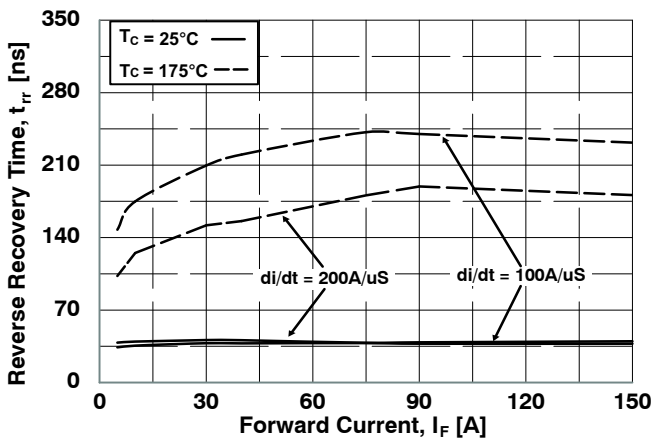

Figure 17. Reverse Recovery Time

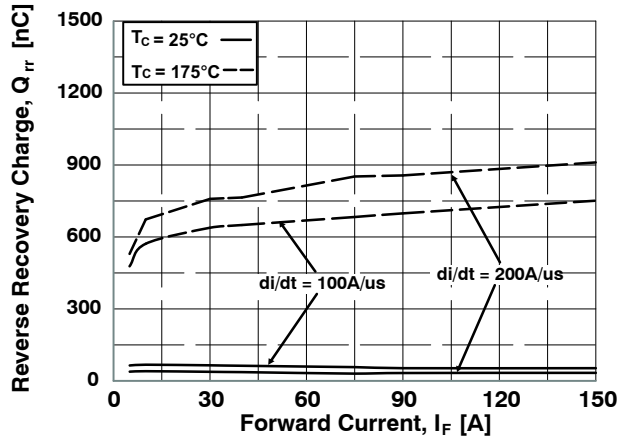

Figure 18. Stored Charge

# FGHL75T65MQD

## TYPICAL CHARACTERISTICS

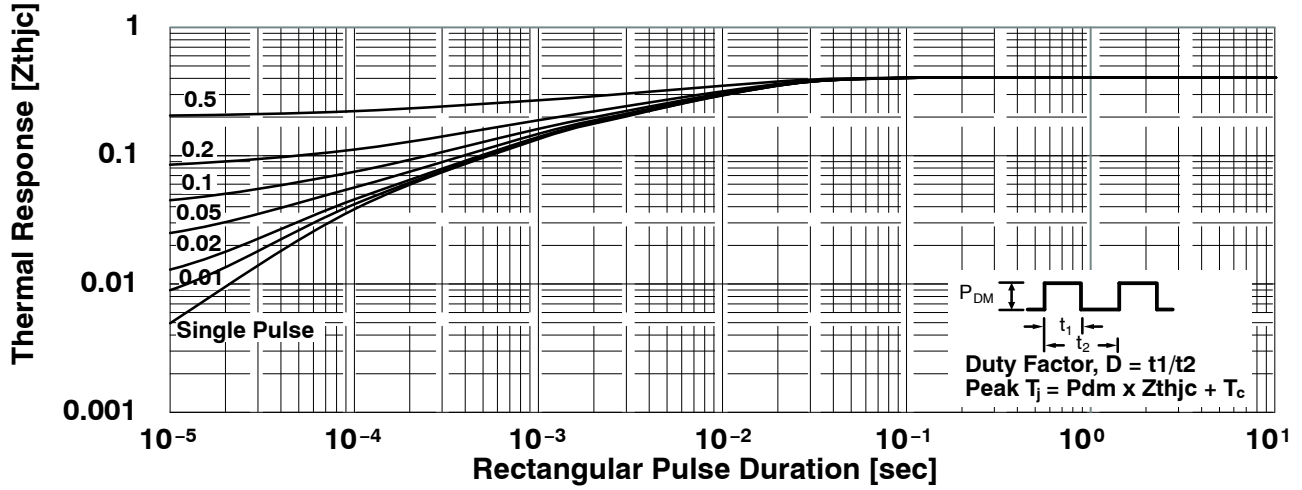

Figure 19. Transient Thermal Impedance of IGBT

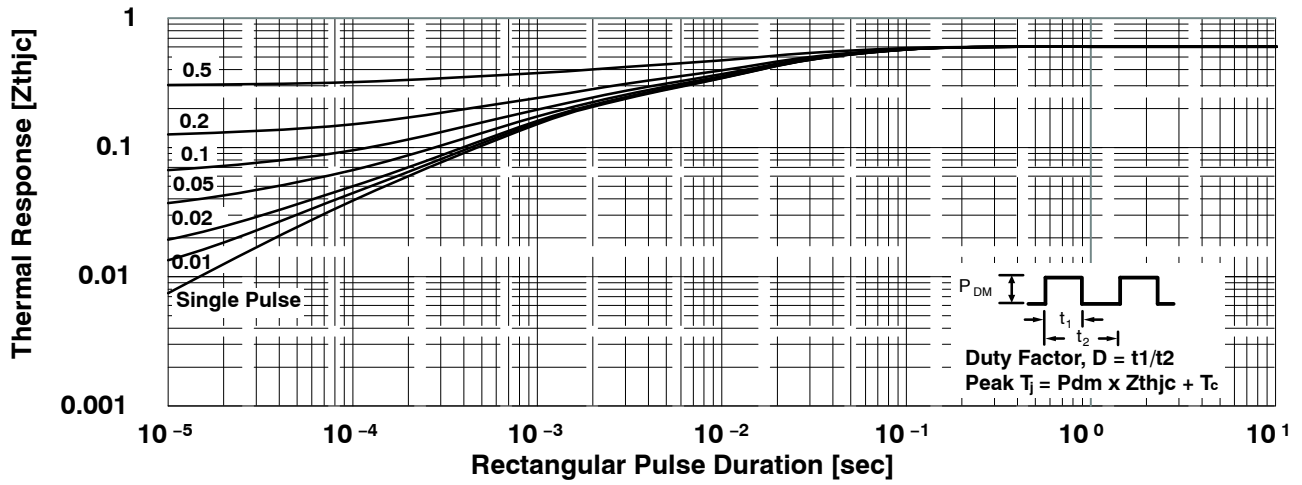

Figure 20. Transient Thermal Impedance of Diode

# MECHANICAL CASE OUTLINE

## PACKAGE DIMENSIONS

ON Semiconductor®



TO-247-3LD  
CASE 340CX  
ISSUE A

DATE 06 JUL 2020



NOTES: UNLESS OTHERWISE SPECIFIED.

- A. DIMENSIONS ARE EXCLUSIVE OF BURRS, MOLD FLASH, AND TIE BAR EXTRUSIONS.
- B. ALL DIMENSIONS ARE IN MILLIMETERS.
- C. DRAWING CONFORMS TO ASME Y14.5 - 2009.
- D. DIMENSION A1 TO BE MEASURED IN THE REGION DEFINED BY L1.
- E. LEAD FINISH IS UNCONTROLLED IN THE REGION DEFINED BY L1.

DIM	MILLIMETERS		
	MIN	NOM	MAX
A	4.58	4.70	4.82
A1	2.20	2.40	2.60
A2	1.40	1.50	1.60
D	20.32	20.57	20.82
E	15.37	15.62	15.87
E2	4.96	5.08	5.20
e	~	5.56	~
L	19.75	20.00	20.25
L1	3.69	3.81	3.93
ØP	3.51	3.58	3.65
Q	5.34	5.46	5.58
S	5.34	5.46	5.58
b	1.17	1.26	1.35
b2	1.53	1.65	1.77
b4	2.42	2.54	2.66
c	0.51	0.61	0.71
D1	13.08	~	~
D2	0.51	0.93	1.35
E1	12.81	~	~
ØP1	6.60	6.80	7.00

### GENERIC MARKING DIAGRAM\*



- XXXXX = Specific Device Code
- A = Assembly Location
- Y = Year
- WW = Work Week
- G = Pb-Free Package

\*This information is generic. Please refer to device data sheet for actual part marking. Pb-Free indicator, "G" or microdot "▪", may or may not be present. Some products may not follow the Generic Marking.

DOCUMENT NUMBER:	98AON93302G	Electronic versions are uncontrolled except when accessed directly from the Document Repository. Printed versions are uncontrolled except when stamped "CONTROLLED COPY" in red.
DESCRIPTION:	TO-247-3LD	PAGE 1 OF 1

ON Semiconductor and are trademarks of Semiconductor Components Industries, LLC dba ON Semiconductor or its subsidiaries in the United States and/or other countries. ON Semiconductor reserves the right to make changes without further notice to any products herein. ON Semiconductor makes no warranty, representation or guarantee regarding the suitability of its products for any particular purpose, nor does ON Semiconductor assume any liability arising out of the application or use of any product or circuit, and specifically disclaims any and all liability, including without limitation special, consequential or incidental damages. ON Semiconductor does not convey any license under its patent rights nor the rights of others.



**onsemi**, **Onsemi**, and other names, marks, and brands are registered and/or common law trademarks of Semiconductor Components Industries, LLC dba "**onsemi**" or its affiliates and/or subsidiaries in the United States and/or other countries. **onsemi** owns the rights to a number of patents, trademarks, copyrights, trade secrets, and other intellectual property. A listing of **onsemi**'s product/patent coverage may be accessed at [www.onsemi.com/site/pdf/Patent-Marking.pdf](http://www.onsemi.com/site/pdf/Patent-Marking.pdf). **onsemi** reserves the right to make changes at any time to any products or information herein, without notice. The information herein is provided "as-is" and **onsemi** makes no warranty, representation or guarantee regarding the accuracy of the information, product features, availability, functionality, or suitability of its products for any particular purpose, nor does **onsemi** assume any liability arising out of the application or use of any product or circuit, and specifically disclaims any and all liability, including without limitation special, consequential or incidental damages. Buyer is responsible for its products and applications using **onsemi** products, including compliance with all laws, regulations and safety requirements or standards, regardless of any support or applications information provided by **onsemi**. "Typical" parameters which may be provided in **onsemi** data sheets and/or specifications can and do vary in different applications and actual performance may vary over time. All operating parameters, including "Typicals" must be validated for each customer application by customer's technical experts. **onsemi** does not convey any license under any of its intellectual property rights nor the rights of others. **onsemi** products are not designed, intended, or authorized for use as a critical component in life support systems or any FDA Class 3 medical devices or medical devices with a same or similar classification in a foreign jurisdiction or any devices intended for implantation in the human body. Should Buyer purchase or use **onsemi** products for any such unintended or unauthorized application, Buyer shall indemnify and hold **onsemi** and its officers, employees, subsidiaries, affiliates, and distributors harmless against all claims, costs, damages, and expenses, and reasonable attorney fees arising out of, directly or indirectly, any claim of personal injury or death associated with such unintended or unauthorized use, even if such claim alleges that **onsemi** was negligent regarding the design or manufacture of the part. **onsemi** is an Equal Opportunity/Affirmative Action Employer. This literature is subject to all applicable copyright laws and is not for resale in any manner.

## ADDITIONAL INFORMATION

### TECHNICAL PUBLICATIONS:

Technical Library: [www.onsemi.com/design/resources/technical-documentation](http://www.onsemi.com/design/resources/technical-documentation)  
onsemi Website: [www.onsemi.com](http://www.onsemi.com)

### ONLINE SUPPORT: [www.onsemi.com/support](http://www.onsemi.com/support)

For additional information, please contact your local Sales Representative at [www.onsemi.com/support/sales](http://www.onsemi.com/support/sales)