

IGBT - SMPS 300 V

FGH50N3

Description

Using ON Semiconductor's planar technology, this IGBT is ideal for many high voltage switching applications operating at high frequencies where low conduction losses are essential. This device has been optimized for medium frequency switch mode power supplies.

Features

- Low Saturation Voltage: $V_{CE(sat)} = 1.4 \text{ V Max}$
- Low $E_{OFF} = 6.6 \text{ uJ/A}$
- $SCWT = 8 \text{ } \mu\text{s @ } = 125^{\circ}\text{C}$
- 300 V Switching SOA Capability
- Positive Temperature Coefficient above 50 A
- This is a Pb-Free Device

Applications

- SMPS



ON Semiconductor®

www.onsemi.com

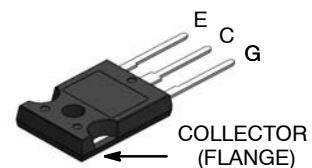
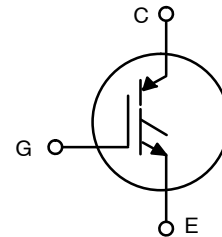

TO-247-3LD
CASE 340CK

MARKING DIAGRAM

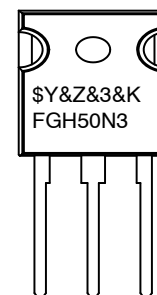

\$Y	= ON Semiconductor Logo
&Z	= Assembly Plant Code
&3	= Numeric Date Code
&K	= Lot Code
FGH50N3	= Specific Device Code

ORDERING INFORMATION

See detailed ordering and shipping information on page 2 of this data sheet.

FGH50N3

MAXIMUM RATINGS (T_C = 25°C unless otherwise noted)

Parameter	Symbol	Ratings	Unit
Collector to Emitter Breakdown Voltage	BV _{CES}	300	V
Collector Current Continuous	I _C	T _C = 25°C	75
		T _C = 110°C	75
Collector Current Pulsed (Note 1)	I _{CM}	240	A
Gate to Emitter Voltage Continuous	V _{GES}	±20	V
Gate to Emitter Voltage Pulsed	V _{GEM}	±30	V
Switching Safe Operating Area at T _J = 150°C, Figure 2	SSOA	150 A at 300 V	
Single Pulse Avalanche Energy, I _{CE} = 30 A, L = 1.78 mH, V _{DD} = 50 V	E _{AS}	800	mJ
Single Pulse Reverse Avalanche Energy, I _{EC} = 30 A, L = 1.78 mH, V _{DD} = 50 V	E _{ARV}	800	mJ
Power Dissipation Total	P _D	T _C = 25°C	463
Power Dissipation Derating		T _C > 25°C	3.7
Operating Junction Temperature Range	T _J	-55 to +150	°C
Storage Temperature Range Range	T _{STG}	-55 to +150	°C
Short Circuit Withstand Time (Note 2)	t _{SC}	8	μs

Stresses exceeding those listed in the Maximum Ratings table may damage the device. If any of these limits are exceeded, device functionality should not be assumed, damage may occur and reliability may be affected.

1. Pulse width limited by maximum junction temperature.
2. V_{CE(PK)} = 180 V, T_J = 125°C, V_{GE} = 12 Vdc, R_G = 5 Ω

PACKAGE MARKING AND ORDERING INFORMATION

Device Marking	Device	Package	Tape Width	Quantity
FGH50N3	FGH50N3	TO-247	N/A	30

THERMAL CHARACTERISTICS

Parameter	Symbol	Test Conditions	Min	Typ	Max	Unit
Thermal Resistance, Junction-Case	R _{θJC}	TO-247	-	-	0.27	°C/W

ELECTRICAL CHARACTERISTICS (T_C = 25°C unless otherwise noted)

Parameter	Symbol	Test Conditions	Min	Typ	Max	Unit
-----------	--------	-----------------	-----	-----	-----	------

OFF STATE CHARACTERISTICS

Collector to Emitter Breakdown Voltage	BV _{CES}	I _{CE} = 250 μA, V _{GE} = 0 V,	300	-	-	V
Emitter to Collector Breakdown Voltage	BV _{ECS}	I _{EC} = 10 mA, V _{GE} = 0 V	15	-	-	V
Collector to Emitter Leakage Current	I _{CES}	V _{CE} = 300 V	T _J = 25°C	-	-	250
			T _J = 125°C	-	-	2.0
Gate to Emitter Leakage Current	I _{GES}	V _{GE} = ±20 V	-	-	±250	nA

ON STATE CHARACTERISTICS

Collector to Emitter Saturation Voltage	V _{CE(SAT)}	I _{CE} = 30 A, V _{GE} = 15 V	T _J = 25°C	-	1.30	1.4	V
			T _J = 125°C	-	1.25	1.4	V

DYNAMIC CHARACTERISTICS

Gate Charge	Q _{G(ON)}	I _{CE} = 30 A, V _{CE} = 150 V	V _{GE} = 15 V	-	180	-	nC
			V _{GE} = 20 V	-	228	-	nC
Gate to Emitter Threshold Voltage	V _{GE(TH)}	I _{CE} = 250 μA, V _{CE} = V _{GE}	4.0	4.8	5.5	V	
Gate to Emitter Plateau Voltage	V _{GEP}	I _{CE} = 30 A, V _{CE} = 150 V	-	7.0	-	V	

FGH50N3

ELECTRICAL CHARACTERISTICS (T_C = 25°C unless otherwise noted) (continued)

Parameter	Symbol	Test Conditions	Min	Typ	Max	Unit
SWITCHING CHARACTERISTICS						
Switching SOA	SSOA	T _J = 150°C, R _G = 5 Ω, V _{GE} = 15 V, L = 25 μH, V _{CE} = 300 V	150	–	–	A
Current Turn-On Delay Time	t _{d(ON)} I	IGBT and Diode at T _J = 25°C, I _{CE} = 30 A, V _{CE} = 180 V, V _{GE} = 15 V, R _G = 5 Ω, , L = 100 μH, Test Circuit – Figure 20	–	20	–	ns
Current Rise Time	t _{rl}		–	15	–	ns
Current Turn-Off Delay Time	t _{d(OFF)} I		–	135	–	ns
Current Fall Time	t _{fl}		–	12	–	ns
Turn-On Energy (Note 3)	E _{ON2}		–	130	–	μJ
Turn-Off Energy Loss (Note 4)	E _{OFF}		–	92	120	μJ
Current Turn-On Delay Time	t _{d(ON)} I	IGBT and Diode at T _J = 125°C, I _{CE} = 30 A, V _{CE} = 180 V, V _{GE} = 15 V, R _G = 5 Ω, , L = 100 μH, Test Circuit – Figure 20	–	19	–	ns
Current Rise Time	t _{rl}		–	13	–	ns
Current Turn-Off Delay Time	t _{d(OFF)} I		–	155	190	ns
Current Fall Time	t _{fl}		–	7	15	ns
Turn-On Energy (Note 3)	E _{ON2}		–	225	270	μJ
Turn-Off Energy (Note 4)	E _{OFF}		–	135	200	μJ

Product parametric performance is indicated in the Electrical Characteristics for the listed test conditions, unless otherwise noted. Product performance may not be indicated by the Electrical Characteristics if operated under different conditions.

- E_{ON2} is the turn-on loss when a typical diode is used in the test circuit and the diode is at the same T_J as the IGBT. The diode type is specified in Figure 20.
- Turn-Off Energy Loss (E_{OFF}) is defined as the integral of the instantaneous power loss starting at the trailing edge of the input pulse and ending at the point where the collector current equals zero (I_{CE} = 0 A). All devices were tested per JEDEC Standard No. 24-1 Method for Measurement of Power Device Turn-Off Switching Loss. This test method produces the true total Turn-Off Energy Loss.

TYPICAL PERFORMANCE CURVES ($T_J = 25^\circ\text{C}$ unless otherwise noted)

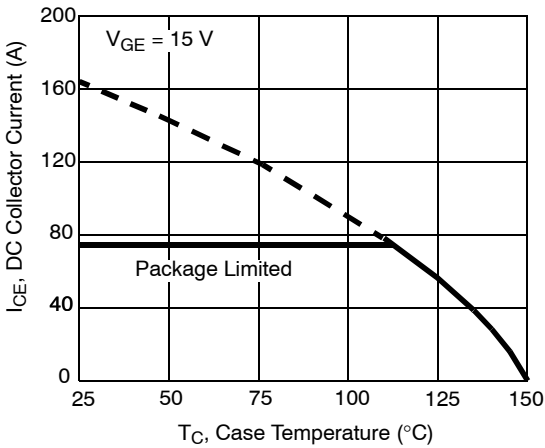

Figure 1. DC Collector Current vs. Case Temperature

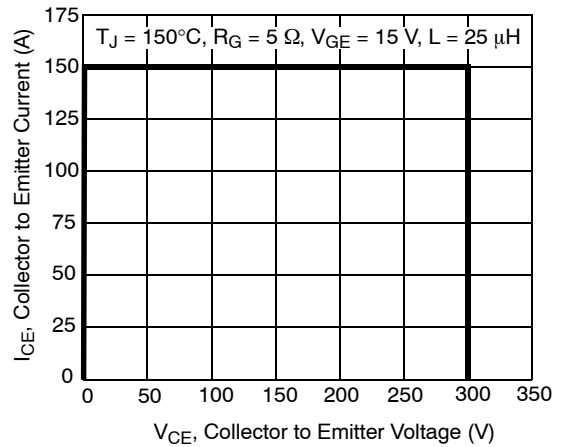

Figure 2. Minimum Switching Safe Operating Area

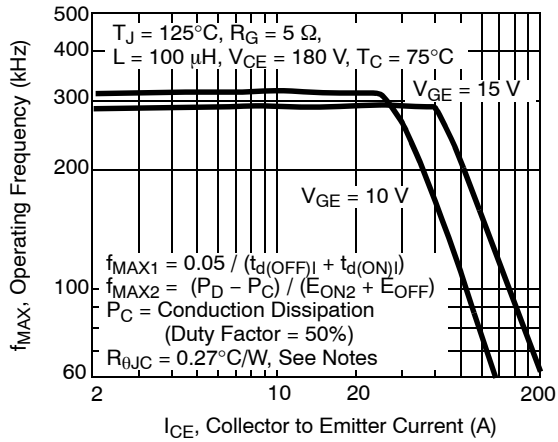

Figure 3. Operating Frequency vs. Collector to Emitter Current

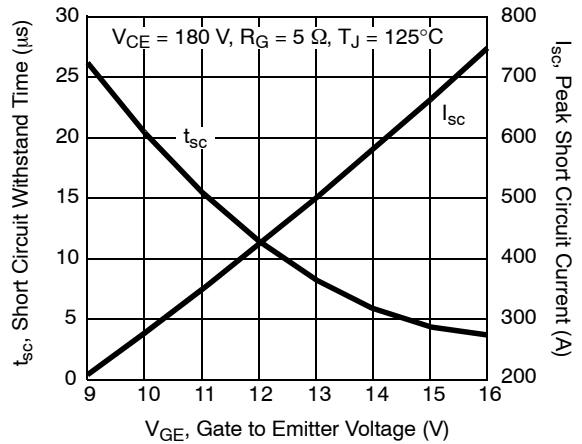

Figure 4. Short Circuit Withstand Time

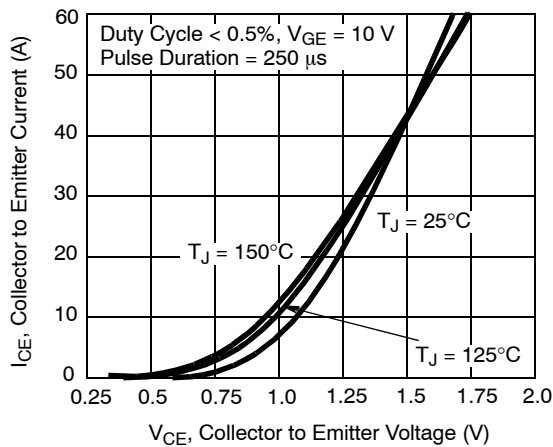

Figure 5. Collector to Emitter On-State Voltage

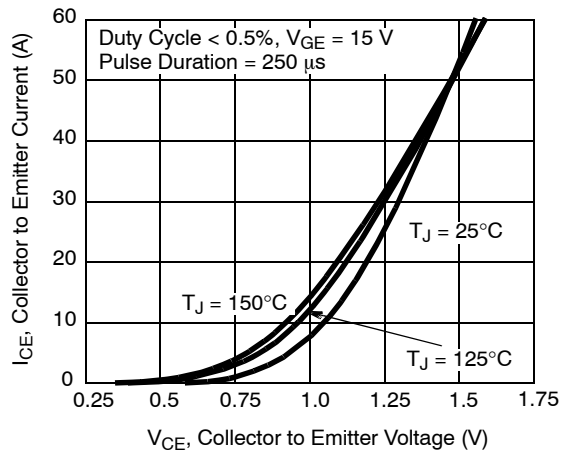

Figure 6. Collector to Emitter On-State Voltage

TYPICAL PERFORMANCE CURVES ($T_J = 25^\circ\text{C}$ unless otherwise noted) (continued)

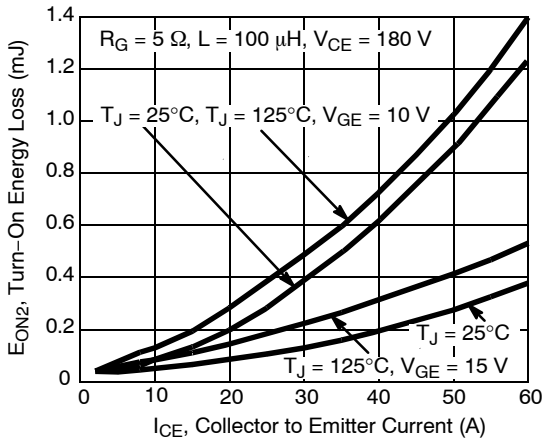

Figure 7. Turn-On Energy Loss vs. Collector to Emitter Current

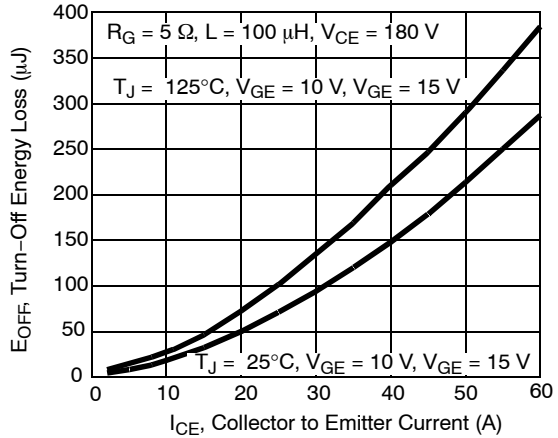

Figure 8. Turn-Off Energy Loss vs. Collector to Emitter Current

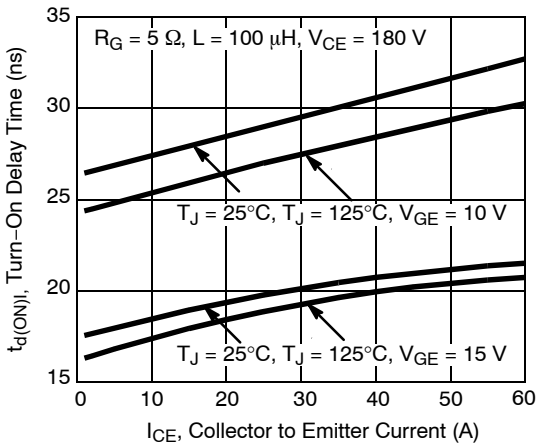

Figure 9. Turn-On Delay Time vs. Collector to Emitter Current

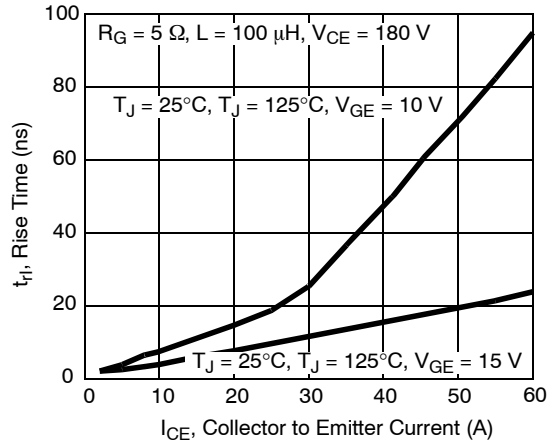

Figure 10. Turn-On Rise Time vs. Collector to Emitter Current

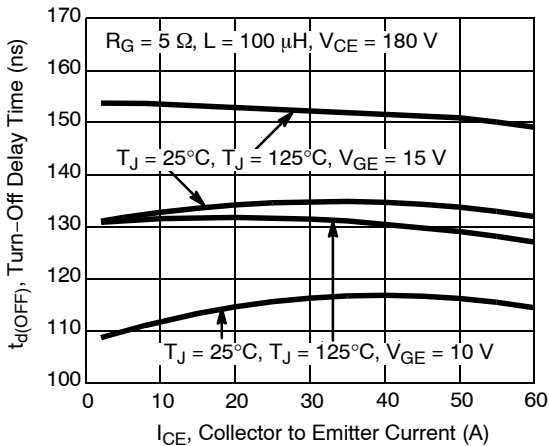

Figure 11. Turn-Off Delay Time vs. Collector to Emitter Current

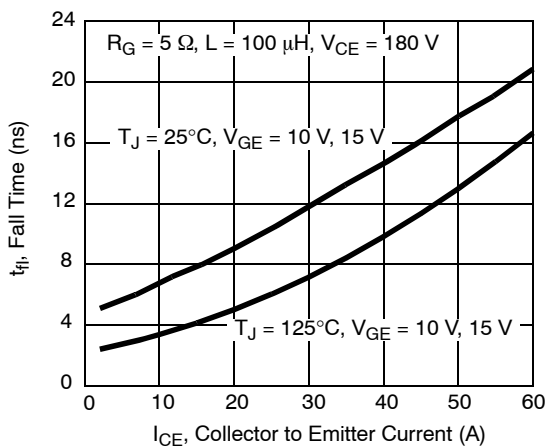

Figure 12. Fall Time vs. Collector to Emitter Current

TYPICAL PERFORMANCE CURVES ($T_J = 25^\circ\text{C}$ unless otherwise noted) (continued)

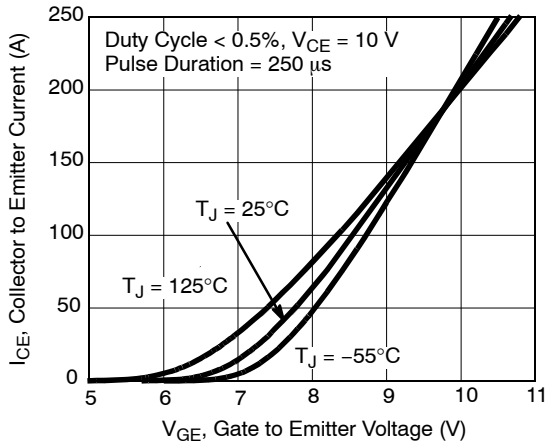

Figure 13. Transfer Characteristics

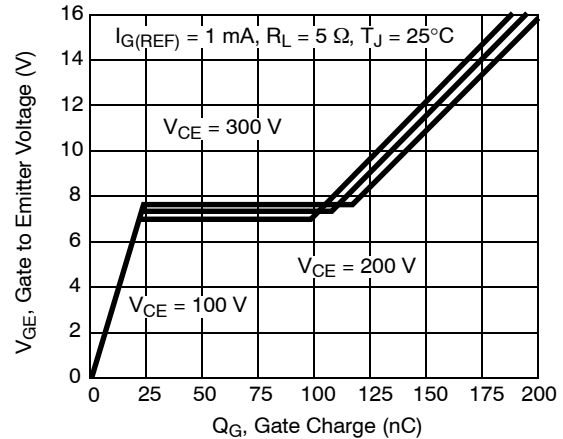

Figure 14. Gate Charge

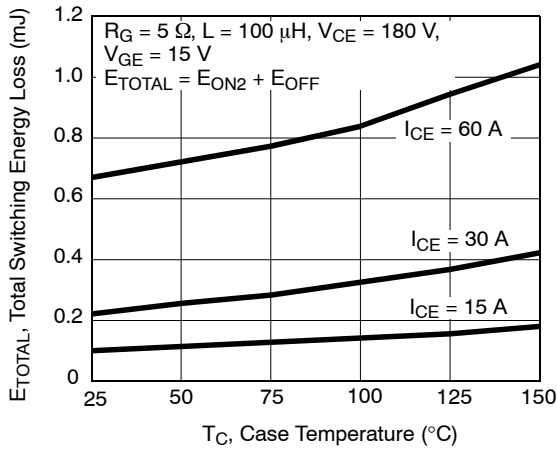

Figure 15. Total Switching Loss vs. Case Temperature

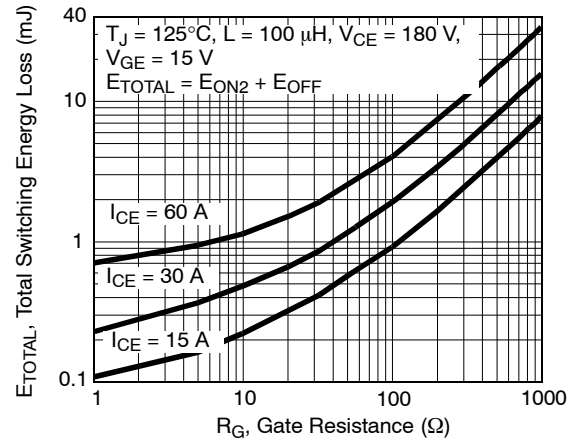

Figure 16. Total Switching Loss vs. Gate Resistance

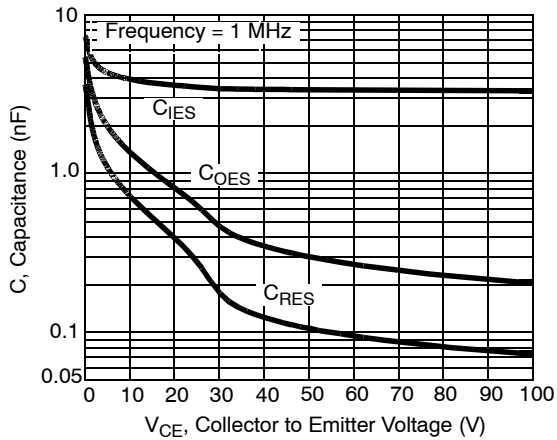

Figure 17. Capacitance vs. Collector to Emitter Voltage

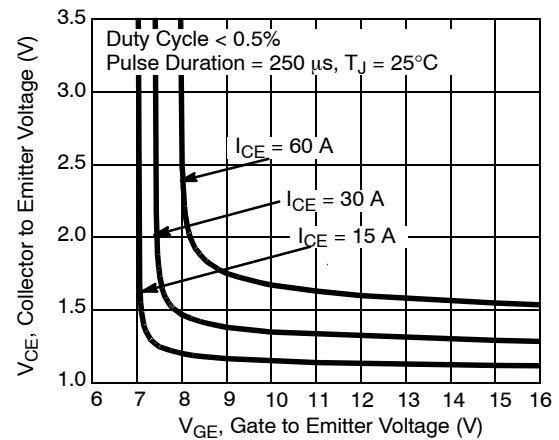

Figure 18. Collector to Emitter On-State Voltage vs. Gate to Emitter Voltage

FGH50N3

TYPICAL PERFORMANCE CURVES ($T_J = 25^\circ\text{C}$ unless otherwise noted) (continued)

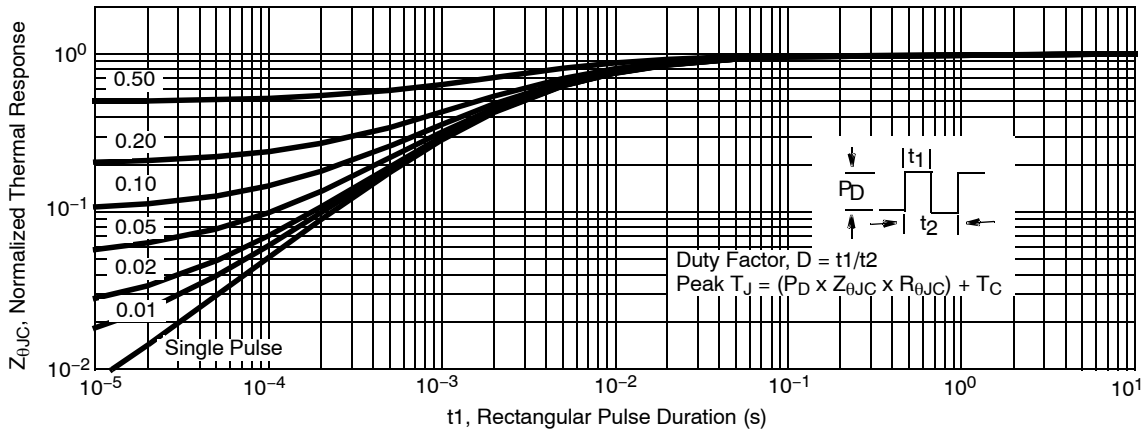

Figure 19. IGBT Normalized Transient Thermal Impedance, Junction to Case

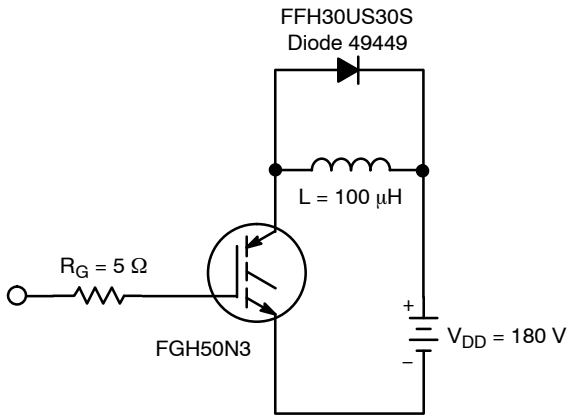

Figure 20. Inductive Switching Test Circuit

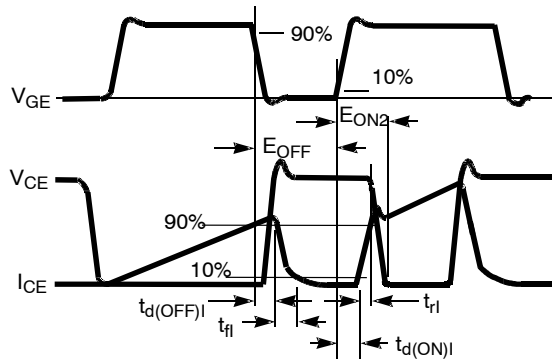
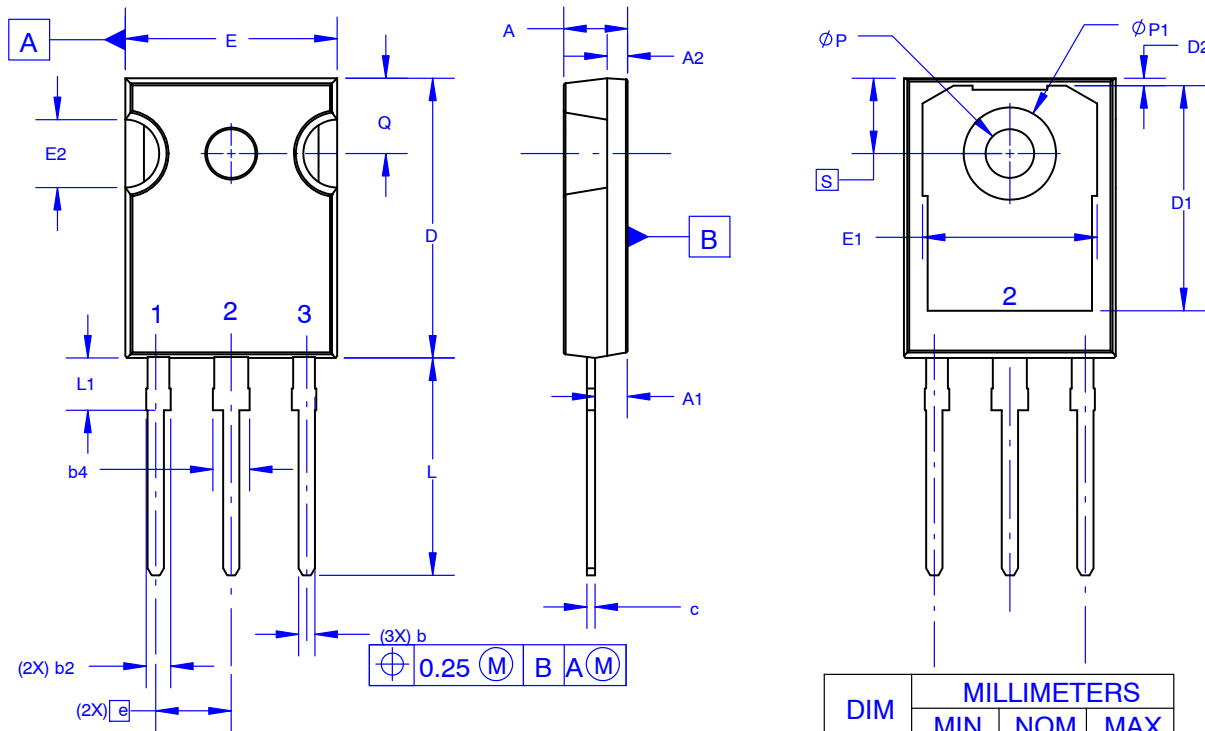

Figure 21. Switching Test Waveforms

TO-247-3LD SHORT LEAD
CASE 340CK
ISSUE A

DATE 31 JAN 2019



NOTES: UNLESS OTHERWISE SPECIFIED.

- A. DIMENSIONS ARE EXCLUSIVE OF BURRS, MOLD FLASH, AND TIE BAR EXTRUSIONS.
- B. ALL DIMENSIONS ARE IN MILLIMETERS.
- C. DRAWING CONFORMS TO ASME Y14.5 - 2009.
- D. DIMENSION A1 TO BE MEASURED IN THE REGION DEFINED BY L1.
- E. LEAD FINISH IS UNCONTROLLED IN THE REGION DEFINED BY L1.

GENERIC
MARKING DIAGRAM*

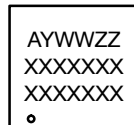

- XXXX = Specific Device Code
- A = Assembly Location
- Y = Year
- WW = Work Week
- ZZ = Assembly Lot Code

*This information is generic. Please refer to device data sheet for actual part marking. Pb-Free indicator, "G" or microdot "•", may or may not be present. Some products may not follow the Generic Marking.

DIM	MILLIMETERS		
	MIN	NOM	MAX
A	4.58	4.70	4.82
A1	2.20	2.40	2.60
A2	1.40	1.50	1.60
b	1.17	1.26	1.35
b2	1.53	1.65	1.77
b4	2.42	2.54	2.66
c	0.51	0.61	0.71
D	20.32	20.57	20.82
D1	13.08	~	~
D2	0.51	0.93	1.35
E	15.37	15.62	15.87
E1	12.81	~	~
E2	4.96	5.08	5.20
e	~	5.56	~
L	15.75	16.00	16.25
L1	3.69	3.81	3.93
ØP	3.51	3.58	3.65
ØP1	6.60	6.80	7.00
Q	5.34	5.46	5.58
S	5.34	5.46	5.58

DOCUMENT NUMBER:	98AON13851G	Electronic versions are uncontrolled except when accessed directly from the Document Repository. Printed versions are uncontrolled except when stamped "CONTROLLED COPY" in red.
DESCRIPTION:	TO-247-3LD SHORT LEAD	PAGE 1 OF 1

onsemi and Onsemi are trademarks of Semiconductor Components Industries, LLC dba onsemi or its subsidiaries in the United States and/or other countries. onsemi reserves the right to make changes without further notice to any products herein. onsemi makes no warranty, representation or guarantee regarding the suitability of its products for any particular purpose, nor does onsemi assume any liability arising out of the application or use of any product or circuit, and specifically disclaims any and all liability, including without limitation special, consequential or incidental damages. onsemi does not convey any license under its patent rights nor the rights of others.

onsemi, **Onsemi**, and other names, marks, and brands are registered and/or common law trademarks of Semiconductor Components Industries, LLC dba "**onsemi**" or its affiliates and/or subsidiaries in the United States and/or other countries. **onsemi** owns the rights to a number of patents, trademarks, copyrights, trade secrets, and other intellectual property. A listing of **onsemi**'s product/patent coverage may be accessed at www.onsemi.com/site/pdf/Patent-Marking.pdf. **onsemi** reserves the right to make changes at any time to any products or information herein, without notice. The information herein is provided "as-is" and **onsemi** makes no warranty, representation or guarantee regarding the accuracy of the information, product features, availability, functionality, or suitability of its products for any particular purpose, nor does **onsemi** assume any liability arising out of the application or use of any product or circuit, and specifically disclaims any and all liability, including without limitation special, consequential or incidental damages. Buyer is responsible for its products and applications using **onsemi** products, including compliance with all laws, regulations and safety requirements or standards, regardless of any support or applications information provided by **onsemi**. "Typical" parameters which may be provided in **onsemi** data sheets and/or specifications can and do vary in different applications and actual performance may vary over time. All operating parameters, including "Typicals" must be validated for each customer application by customer's technical experts. **onsemi** does not convey any license under any of its intellectual property rights nor the rights of others. **onsemi** products are not designed, intended, or authorized for use as a critical component in life support systems or any FDA Class 3 medical devices or medical devices with a same or similar classification in a foreign jurisdiction or any devices intended for implantation in the human body. Should Buyer purchase or use **onsemi** products for any such unintended or unauthorized application, Buyer shall indemnify and hold **onsemi** and its officers, employees, subsidiaries, affiliates, and distributors harmless against all claims, costs, damages, and expenses, and reasonable attorney fees arising out of, directly or indirectly, any claim of personal injury or death associated with such unintended or unauthorized use, even if such claim alleges that **onsemi** was negligent regarding the design or manufacture of the part. **onsemi** is an Equal Opportunity/Affirmative Action Employer. This literature is subject to all applicable copyright laws and is not for resale in any manner.

ADDITIONAL INFORMATION

TECHNICAL PUBLICATIONS:

Technical Library: www.onsemi.com/design/resources/technical-documentation
onsemi Website: www.onsemi.com

ONLINE SUPPORT: www.onsemi.com/support

For additional information, please contact your local Sales Representative at www.onsemi.com/support/sales