

ON Semiconductor

Is Now

onsemi™

To learn more about onsemi™, please visit our website at
www.onsemi.com

onsemi and **onsemi** and other names, marks, and brands are registered and/or common law trademarks of Semiconductor Components Industries, LLC dba "**onsemi**" or its affiliates and/or subsidiaries in the United States and/or other countries. **onsemi** owns the rights to a number of patents, trademarks, copyrights, trade secrets, and other intellectual property. A listing of **onsemi** product/patent coverage may be accessed at www.onsemi.com/site/pdf/Patent-Marking.pdf. **onsemi** reserves the right to make changes at any time to any products or information herein, without notice. The information herein is provided "as-is" and **onsemi** makes no warranty, representation or guarantee regarding the accuracy of the information, product features, availability, functionality, or suitability of its products for any particular purpose, nor does **onsemi** assume any liability arising out of the application or use of any product or circuit, and specifically disclaims any and all liability, including without limitation special, consequential or incidental damages. Buyer is responsible for its products and applications using **onsemi** products, including compliance with all laws, regulations and safety requirements or standards, regardless of any support or applications information provided by **onsemi**. "Typical" parameters which may be provided in **onsemi** data sheets and/or specifications can and do vary in different applications and actual performance may vary over time. All operating parameters, including "Typicals" must be validated for each customer application by customer's technical experts. **onsemi** does not convey any license under any of its intellectual property rights nor the rights of others. **onsemi** products are not designed, intended, or authorized for use as a critical component in life support systems or any FDA Class 3 medical devices or medical devices with a same or similar classification in a foreign jurisdiction or any devices intended for implantation in the human body. Should Buyer purchase or use **onsemi** products for any such unintended or unauthorized application, Buyer shall indemnify and hold **onsemi** and its officers, employees, subsidiaries, affiliates, and distributors harmless against all claims, costs, damages, and expenses, and reasonable attorney fees arising out of, directly or indirectly, any claim of personal injury or death associated with such unintended or unauthorized use, even if such claim alleges that **onsemi** was negligent regarding the design or manufacture of the part. **onsemi** is an Equal Opportunity/Affirmative Action Employer. This literature is subject to all applicable copyright laws and is not for resale in any manner. Other names and brands may be claimed as the property of others.

IGBT – Field Stop, Trench

650 V, 50 A

FGH4L50T65SQD

Description

Using novel field stop IGBT technology, ON Semiconductor’s new series of field stop 4th generation IGBTs offer the optimum performance for solar inverter, UPS, welder, telecom, ESS and PFC applications where low conduction and switching losses are essential.

Features

- Maximum Junction Temperature: $T_J = 175^\circ\text{C}$
- Positive Temperature Co-efficient for Easy Parallel Operating
- High Current Capability
- Low Saturation Voltage: $V_{CE(Sat)} = 1.6\text{ V (Typ.) @ } I_C = 50\text{ A}$
- 100% of the Parts are Tested for I_{LM}
- High Input Impedance
- Fast Switching
- Tight Parameter Distribution
- This Device is Pb-Free and is RoHS Compliant

Applications

- Solar Inverter, UPS, Welder, Telecom, ESS, PFC



ON Semiconductor®

www.onsemi.com

V_{CES}	I_C
650 V	50 A

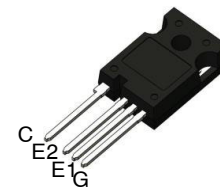
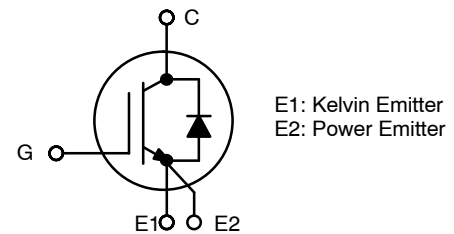

TO-247-4LD
CASE 340CJ

MARKING DIAGRAM

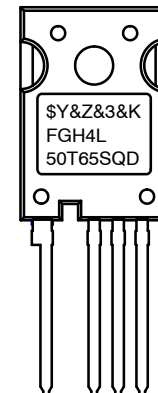

- \$Y = ON Semiconductor Logo
- &Z = Assembly Plant Code
- &3 = Numeric Date Code
- &K = Lot Code
- FGH4L50T65SQD = Specific Device Code

ORDERING INFORMATION

Device	Package	Shipping
FGH4L50T65SQD	TO-247-4LD	30 Units / Rail

FGH4L50T65SQD

ABSOLUTE MAXIMUM RATINGS

Symbol	Rating	Value	Unit
V_{CES}	Collector to Emitter Voltage	650	V
V_{GES}	Gate to Emitter Voltage	+20	V
	Transient Gate to Emitter Voltage	+30	V
I_C	Collector Current (Note 1) $T_C = 25^\circ\text{C}$ $T_C = 100^\circ\text{C}$	80	A
		50	
I_{LM}	Pulsed Collector Current (Note 2), $T_C = 25^\circ\text{C}$	200	A
I_{CM}	Pulsed Collector Current (Note 3)	200	A
I_F	Diode Forward Current (Note 1) $T_C = 25^\circ\text{C}$ $T_C = 100^\circ\text{C}$	40	A
		30	
I_{FM}	Pulsed Diode Maximum Forward Current	200	A
P_D	Maximum Power Dissipation $T_C = 25^\circ\text{C}$ $T_C = 100^\circ\text{C}$	268	W
		134	
T_J	Operating Junction Temperature	-55 to +175	$^\circ\text{C}$
T_{STG}	Storage Temperature Range	-55 to +175	$^\circ\text{C}$
T_L	Maximum Lead Temp. for Soldering Purposes, 1/8" from Case for 5 Seconds	265	$^\circ\text{C}$

Stresses exceeding those listed in the Maximum Ratings table may damage the device. If any of these limits are exceeded, device functionality should not be assumed, damage may occur and reliability may be affected.

1. Value limited by bond wire.
2. $V_{CC} = 400\text{ V}$, $V_{GE} = 15\text{ V}$, $I_C = 200\text{ A}$, $R_G = 15\ \Omega$, Inductive Load.
3. Repetitive rating: Pulse width limited by max. junction temperature.

THERMAL CHARACTERISTICS

Symbol	Characteristics	Value	Unit
$R_{\theta JC}$ (IGBT)	Thermal Resistance, Junction to Case, Max.	0.56	$^\circ\text{C/W}$
$R_{\theta JC}$ (Diode)	Thermal Resistance, Junction to Case, Max.	1.25	$^\circ\text{C/W}$
$R_{\theta JA}$	Thermal Resistance, Junction to Ambient, Max.	40	$^\circ\text{C/W}$

ELECTRICAL CHARACTERISTICS OF THE IGBT ($T_J = 25^\circ\text{C}$ unless otherwise noted)

Symbol	Parameter	Test Conditions	Min	Typ	Max	Unit
--------	-----------	-----------------	-----	-----	-----	------

OFF CHARACTERISTICS

BV_{CES}	Collector to Emitter Breakdown Voltage	$V_{GE} = 0\text{ V}$, $I_C = 1\text{ mA}$	650	-	-	V
$\Delta BV_{CES} / \Delta T_J$	Temperature Coefficient of Breakdown Voltage	$V_{GE} = 0\text{ V}$, $I_C = 1\text{ mA}$	-	0.6	-	$\text{V}/^\circ\text{C}$
I_{CES}	Collector Cut-Off Current	$V_{CE} = V_{CES}$, $V_{GE} = 0\text{ V}$	-	-	250	μA
I_{GES}	G-E Leakage Current	$V_{GE} = V_{GES}$, $V_{CE} = 0\text{ V}$	-	-	± 400	nA

ON CHARACTERISTICS

$V_{GE(th)}$	G-E Threshold Voltage	$I_C = 50\text{ mA}$, $V_{CE} = V_{GE}$	2.6	4.5	6.4	V
$V_{CE(sat)}$	Collector to Emitter Saturation Voltage	$I_C = 50\text{ A}$, $V_{GE} = 15\text{ V}$	-	1.6	2.1	V
		$I_C = 50\text{ A}$, $V_{GE} = 15\text{ V}$, $T_J = 175^\circ\text{C}$	-	1.92	-	V

DYNAMIC CHARACTERISTICS

C_{ies}	Input Capacitance	$V_{CE} = 30\text{ V}$, $V_{GE} = 0\text{ V}$, $f = 1\text{ MHz}$	-	3070	-	pF
C_{oes}	Output Capacitance		-	84	-	pF
C_{res}	Reverse Transfer Capacitance		-	10	-	pF

FGH4L50T65SQD

ELECTRICAL CHARACTERISTICS OF THE IGBT ($T_J = 25^\circ\text{C}$ unless otherwise noted) (continued)

Symbol	Parameter	Test Conditions	Min	Typ	Max	Unit
SWITCHING CHARACTERISTICS, INDUCTIVE LOAD						
$T_{d(on)}$	Turn-On Delay Time	$V_{CC} = 400\text{ V}, I_C = 25\text{ A},$ $R_G = 15\ \Omega, V_{GE} = 15\text{ V},$ Inductive Load, $T_J = 25^\circ\text{C}$	-	22.40	-	ns
T_r	Rise Time		-	11.20	-	ns
$T_{d(off)}$	Turn-Off Delay Time		-	162	-	ns
T_f	Fall Time		-	8	-	ns
E_{on}	Turn-On Switching Loss		-	0.28	-	mJ
E_{off}	Turn-Off Switching Loss		-	0.20	-	mJ
E_{ts}	Total Switching Loss		-	0.48	-	mJ
$T_{d(on)}$	Turn-On Delay Time	$V_{CC} = 400\text{ V}, I_C = 50\text{ A},$ $R_G = 15\ \Omega, V_{GE} = 15\text{ V},$ Inductive Load, $T_J = 25^\circ\text{C}$	-	24	-	ns
T_r	Rise Time		-	20.80	-	ns
$T_{d(off)}$	Turn-Off Delay Time		-	158.40	-	ns
T_f	Fall Time		-	11.20	-	ns
E_{on}	Turn-On Switching Loss		-	0.66	-	mJ
E_{off}	Turn-Off Switching Loss		-	0.44	-	mJ
E_{ts}	Total Switching Loss		-	1.10	-	mJ
$T_{d(on)}$	Turn-On Delay Time	$V_{CC} = 400\text{ V}, I_C = 25\text{ A},$ $R_G = 15\ \Omega, V_{GE} = 15\text{ V},$ Inductive Load, $T_J = 175^\circ\text{C}$	-	19.20	-	ns
T_r	Rise Time		-	16	-	ns
$T_{d(off)}$	Turn-Off Delay Time		-	178	-	ns
T_f	Fall Time		-	6.40	-	ns
E_{on}	Turn-On Switching Loss		-	0.59	-	mJ
E_{off}	Turn-Off Switching Loss		-	0.32	-	mJ
E_{ts}	Total Switching Loss		-	0.91	-	mJ
$T_{d(on)}$	Turn-On Delay Time	$V_{CC} = 400\text{ V}, I_C = 50\text{ A},$ $R_G = 15\ \Omega, V_{GE} = 15\text{ V},$ Inductive Load, $T_J = 175^\circ\text{C}$	-	22.40	-	ns
T_r	Rise Time		-	26.40	-	ns
$T_{d(off)}$	Turn-Off Delay Time		-	168	-	ns
T_f	Fall Time		-	11.20	-	ns
E_{on}	Turn-On Switching Loss		-	1.16	-	mJ
E_{off}	Turn-Off Switching Loss		-	0.68	-	mJ
E_{ts}	Total Switching Loss		-	1.84	-	mJ
Q_g	Total Gate Charge	$V_{CE} = 400\text{ V}, I_C = 50\text{ A},$ $V_{GE} = 15\text{ V}$	-	92	-	nC
Q_{ge}	Gate to Emitter Charge		-	17	-	nC
Q_{gc}	Gate to Collector Charge		-	21	-	nC

Product parametric performance is indicated in the Electrical Characteristics for the listed test conditions, unless otherwise noted. Product performance may not be indicated by the Electrical Characteristics if operated under different conditions.

FGH4L50T65SQD

DIODE CHARACTERISTICS ($T_J = 25^\circ\text{C}$ unless otherwise noted)

Symbol	Parameter	Test Conditions	Min	Typ	Max	Unit	
V_{FM}	Diode Forward Voltage	$I_F = 30\text{ A}$	$T_J = 25^\circ\text{C}$	-	2.1	2.6	V
			$T_J = 175^\circ\text{C}$	-	1.8	-	

DIODE SWITCHING CHARACTERISTICS, INDUCTIVE LOAD

E_{rec}	Reverse Recovery Energy	$T_J = 25^\circ\text{C}, V_{CE} = 400\text{ V}, I_F = 15\text{ A},$ $di_F/dt = 1000\text{ A}/\mu\text{s}$	-	11	-	μJ
T_{rr}	Diode Reverse Recovery Time		-	25	-	ns
Q_{rr}	Diode Reverse Recovery Charge		-	175	-	nC
I_{rr}	Diode Reverse Recovery Current		-	14	-	A
E_{rec}	Reverse Recovery Energy	$T_J = 25^\circ\text{C}, V_{CE} = 400\text{ V}, I_F = 30\text{ A},$ $di_F/dt = 1000\text{ A}/\mu\text{s}$	-	11	-	μJ
T_{rr}	Diode Reverse Recovery Time		-	29	-	ns
Q_{rr}	Diode Reverse Recovery Charge		-	205	-	nC
I_{rr}	Diode Reverse Recovery Current		-	14	-	A
E_{rec}	Reverse Recovery Energy	$T_J = 175^\circ\text{C}, V_{CE} = 400\text{ V}, I_F = 15\text{ A},$ $di_F/dt = 1000\text{ A}/\mu\text{s}$	-	98	-	μJ
T_{rr}	Diode Reverse Recovery Time		-	70	-	ns
Q_{rr}	Diode Reverse Recovery Charge		-	830	-	nC
I_{rr}	Diode Reverse Recovery Current		-	23	-	A
E_{rec}	Reverse Recovery Energy	$T_J = 175^\circ\text{C}, V_{CE} = 400\text{ V}, I_F = 30\text{ A},$ $di_F/dt = 1000\text{ A}/\mu\text{s}$	-	112	-	μJ
T_{rr}	Diode Reverse Recovery Time		-	89	-	ns
Q_{rr}	Diode Reverse Recovery Charge		-	1031	-	nC
I_{rr}	Diode Reverse Recovery Current		-	23	-	A

FGH4L50T65SQD

TYPICAL CHARACTERISTICS

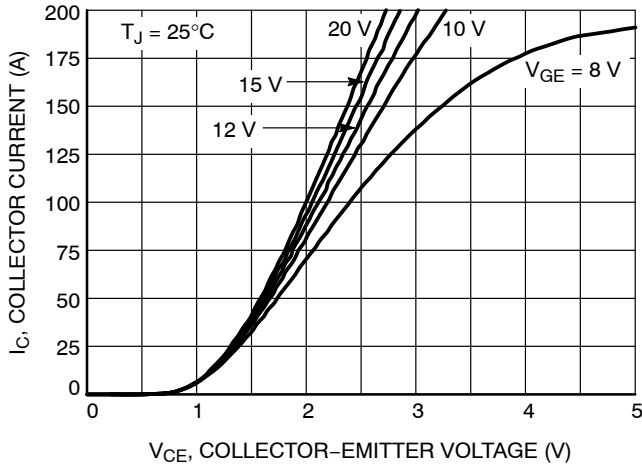

Figure 1. Typical Output Characteristics

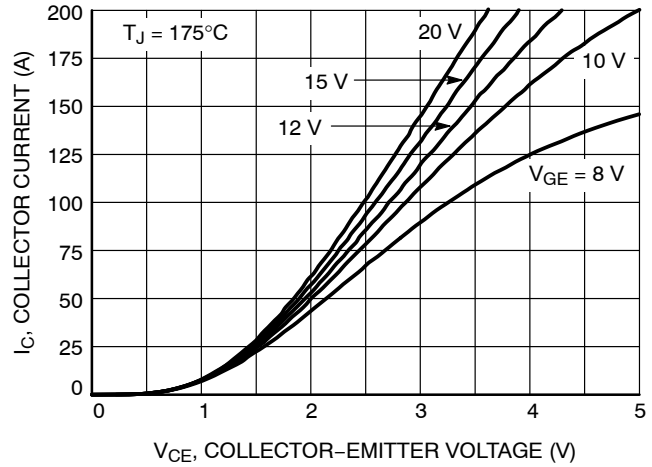

Figure 2. Typical Output Characteristics

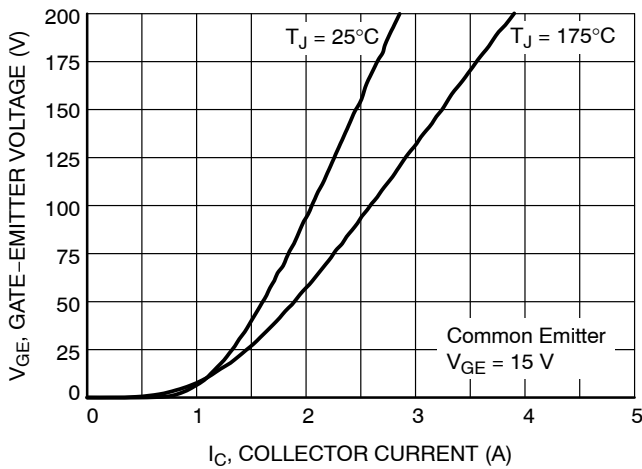

Figure 3. Typical Saturation Voltage Characteristics

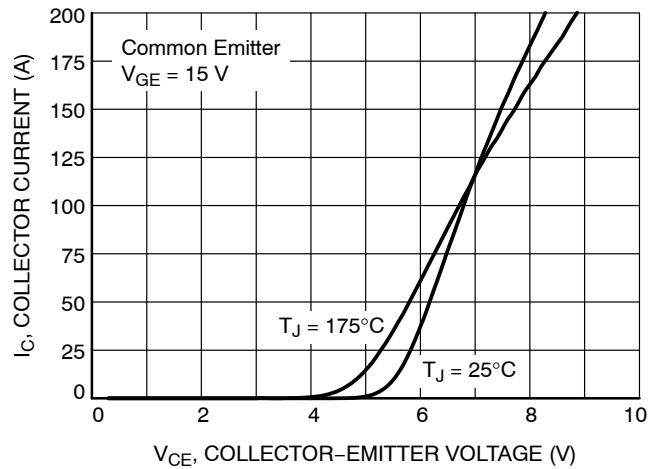

Figure 4. Typical Transfer Characteristics

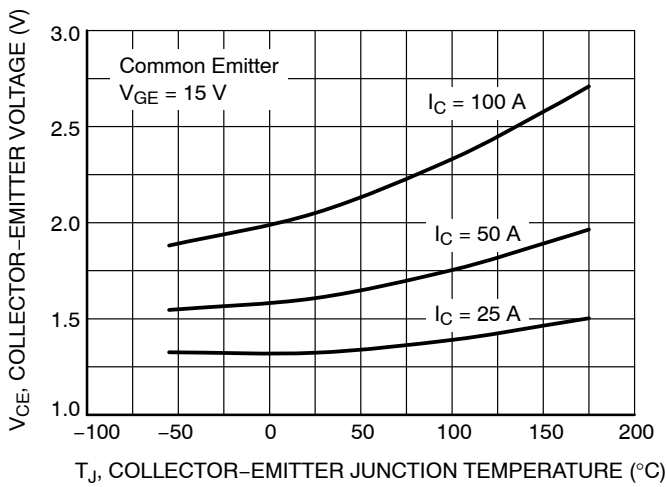

Figure 5. Saturation Voltage vs. Junction Temperature

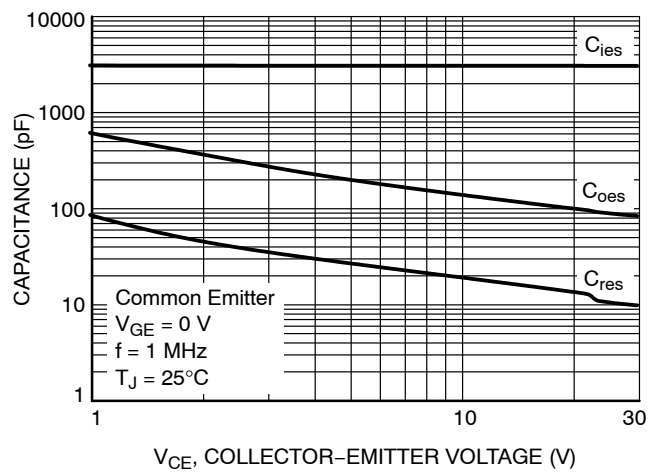

Figure 6. Capacitance Characteristics

FGH4L50T65SQD

TYPICAL CHARACTERISTICS

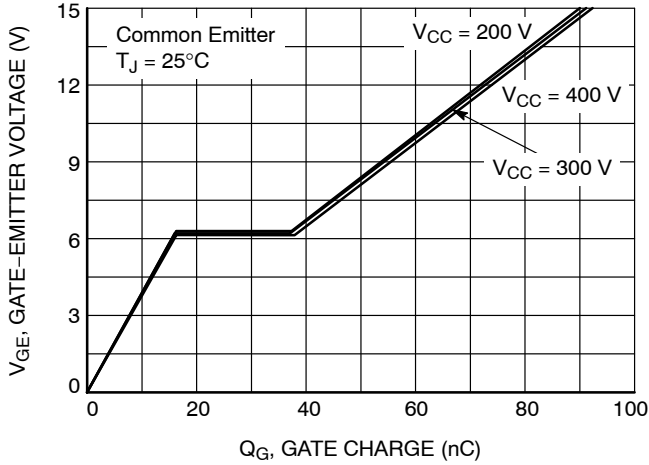

Figure 7. Gate Charge Characteristic

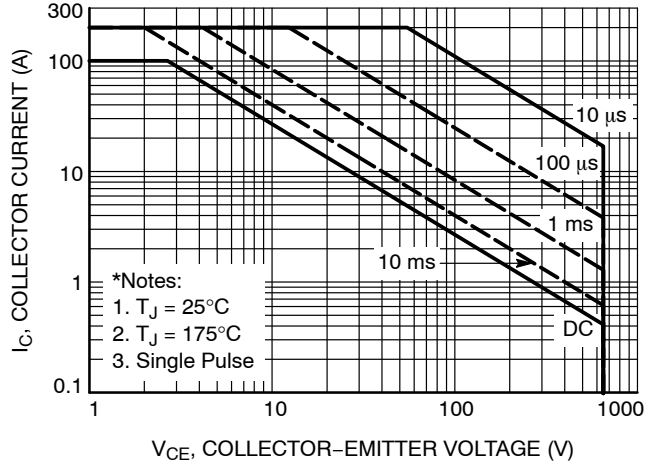

Figure 8. SOA Characteristics (FBSOA)

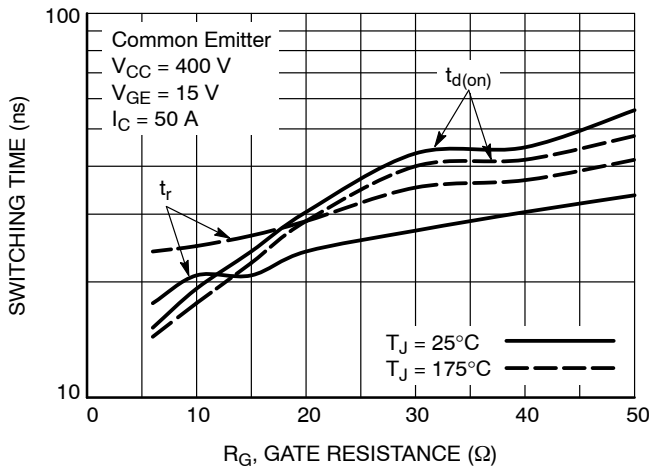

Figure 9. Turn-On Characteristics vs. Gate Resistance

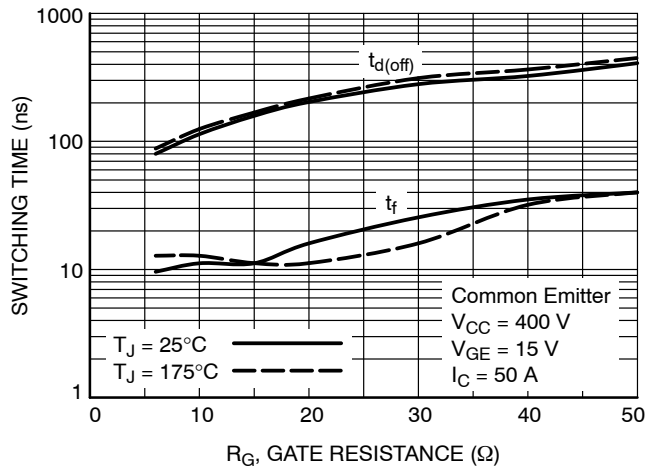

Figure 10. Turn-Off Characteristics vs. Gate Resistance

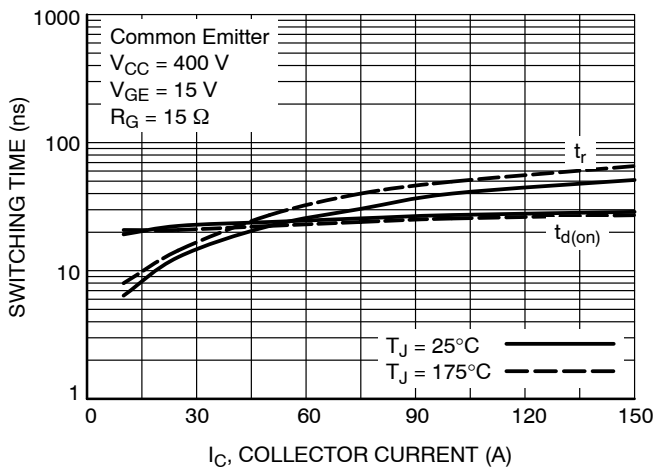

Figure 11. Turn-On Characteristics vs. Collector Current

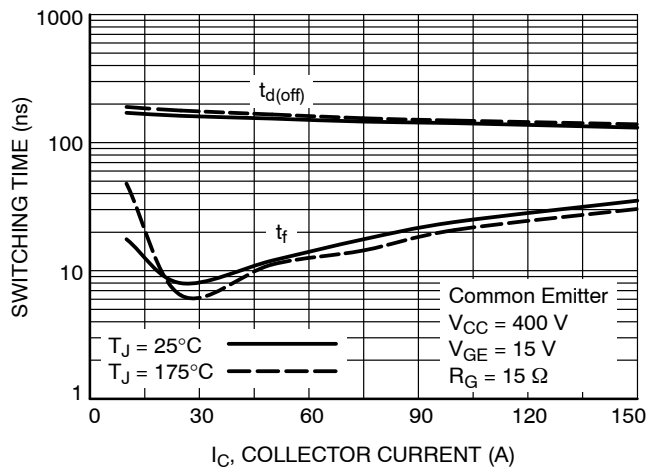

Figure 12. Turn-Off Characteristics vs. Collector Current

FGH4L50T65SQD

TYPICAL CHARACTERISTICS

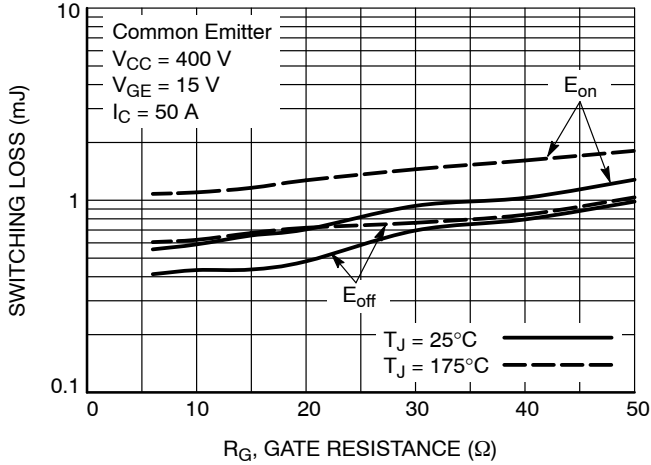

Figure 13. Switching Loss vs. Gate Resistance

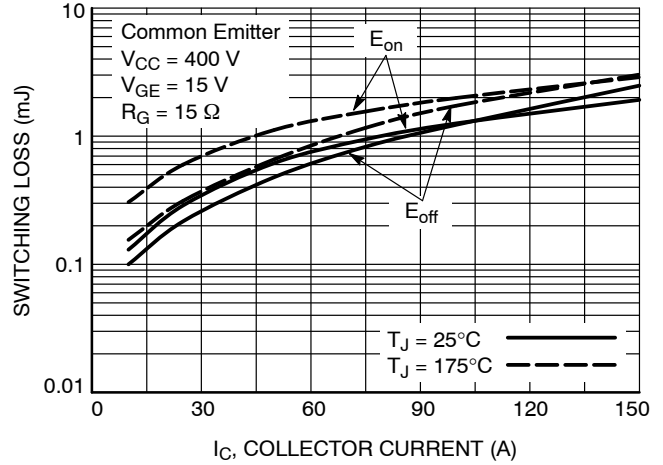

Figure 14. Switching Loss vs. Collector Current

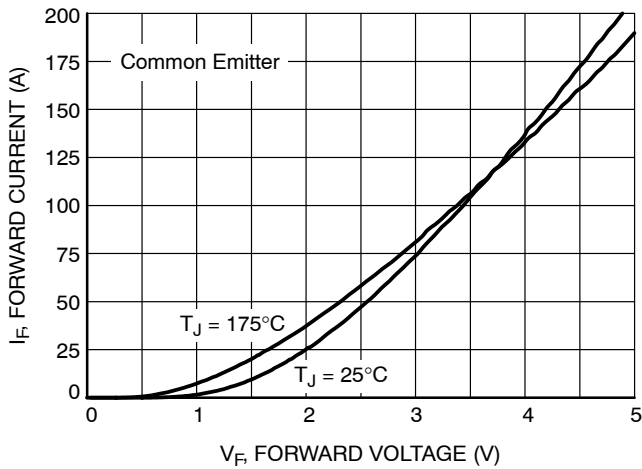

Figure 15. (Diode) Forward Characteristics

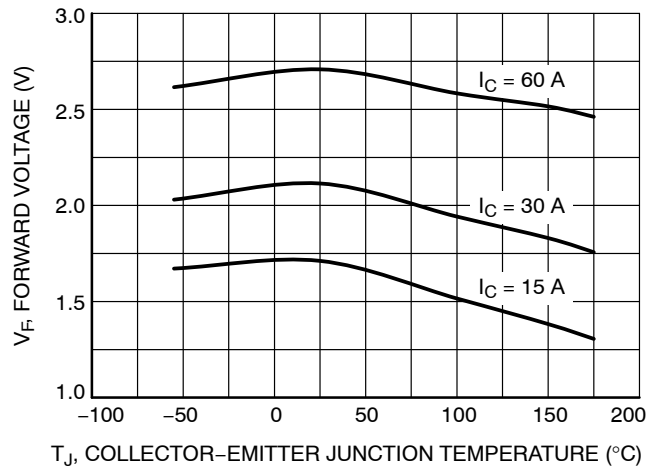

Figure 16. (Diode) Forward Voltage vs. Junction Temperature

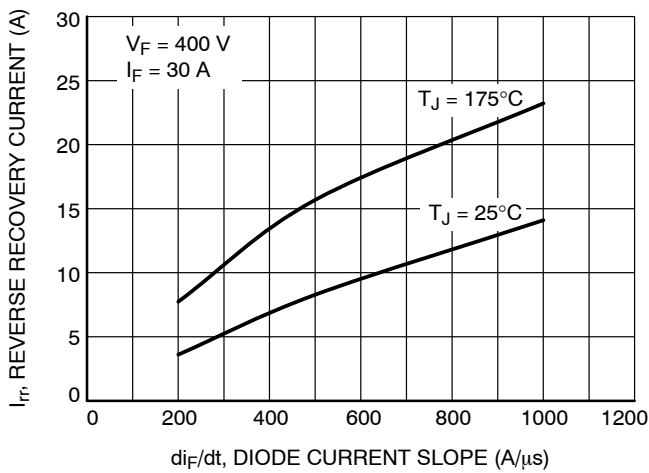

Figure 17. Reverse Recovery Current (I_{rr})

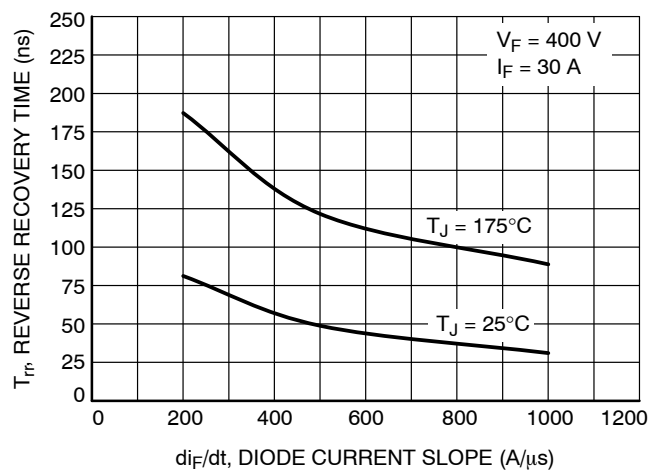

Figure 18. Reverse Recovery Time (T_{rr})

FGH4L50T65SQD

TYPICAL CHARACTERISTICS

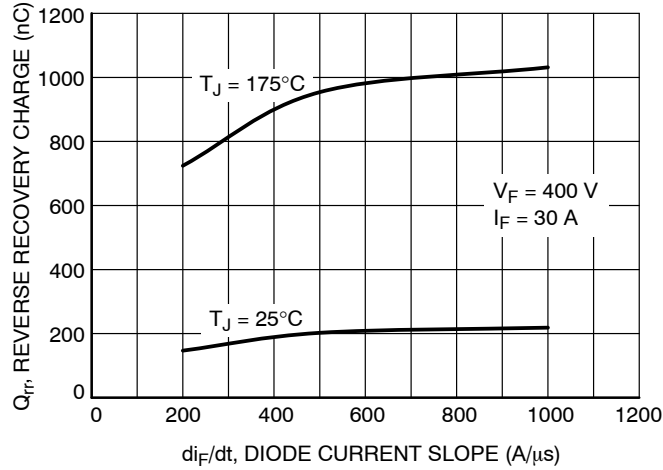

Figure 19. Stored Charge (Q_{rr})

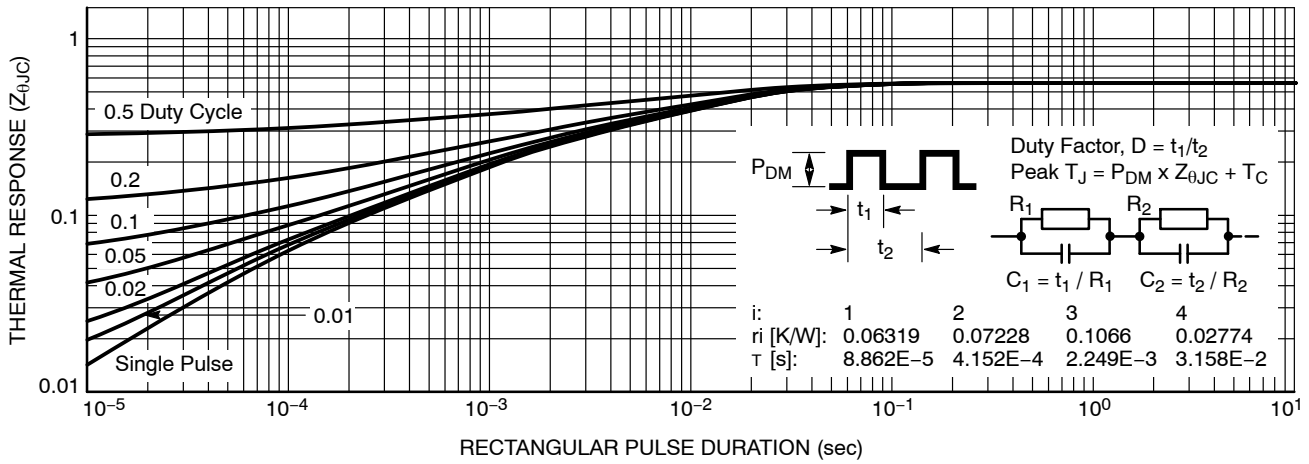

Figure 20. Transient Thermal Impedance of IGBT

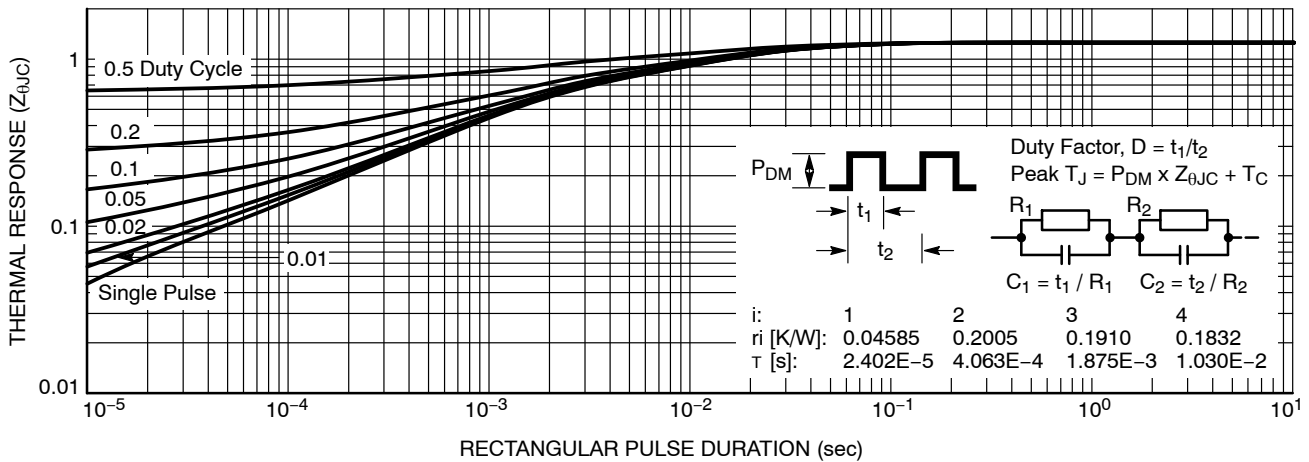
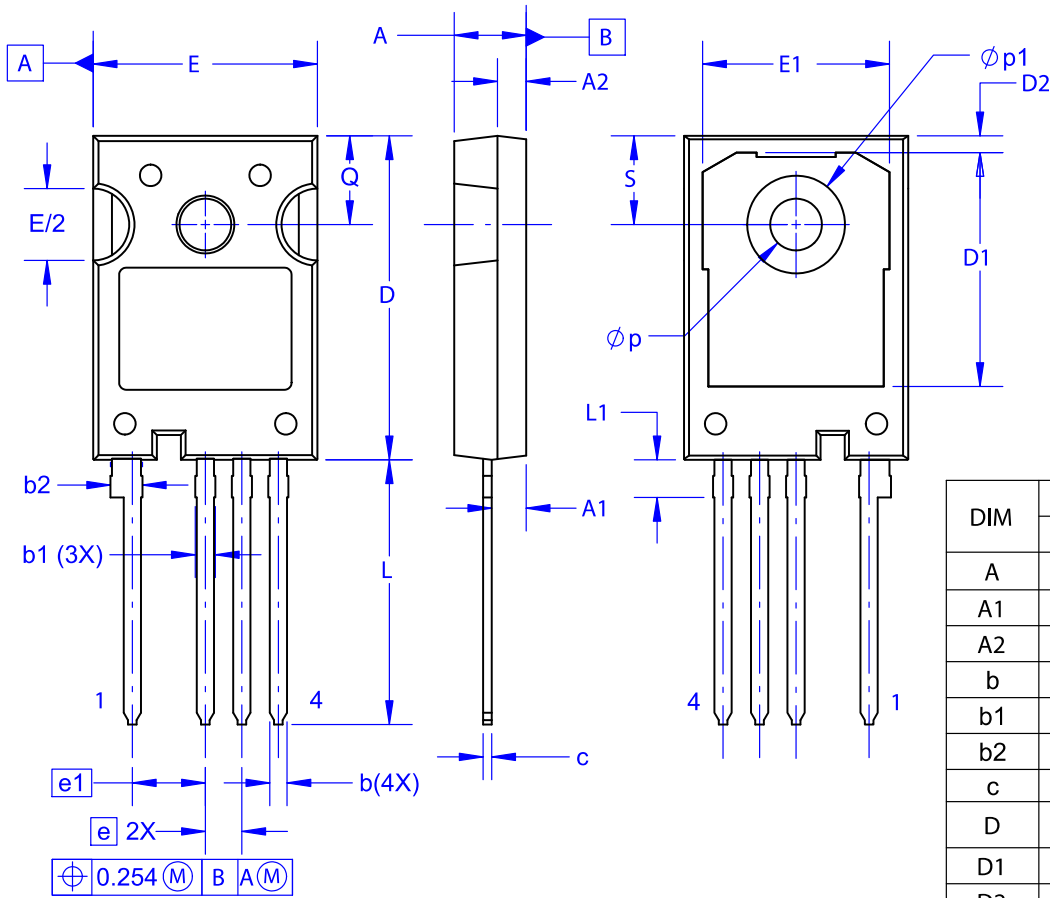

Figure 21. Transient Thermal Impedance of Diode

FGH4L50T65SQD

PACKAGE DIMENSIONS

TO-247-4LD
CASE 340CJ
ISSUE A



DIM	MILLIMETERS		
	MIN	NOM	MAX
A	4.80	5.00	5.20
A1	2.10	2.40	2.70
A2	1.80	2.00	2.20
b	1.07	1.20	1.33
b1	1.20	1.40	1.60
b2	2.02	2.22	2.42
c	0.50	0.60	0.70
D	22.34	22.54	22.74
D1	16.00	16.25	16.50
D2	0.97	1.17	1.37
e	2.54 BSC		
e1	5.08 BSC		
E	15.40	15.60	15.80
E1	12.80	13.00	13.20
E/2	4.80	5.00	5.20
L	18.22	18.42	18.62
L1	2.42	2.62	2.82
p	3.40	3.60	3.80
p1	6.60	6.80	7.00
Q	5.97	6.17	6.37
S	5.97	6.17	6.37

NOTES:

- A. NO INDUSTRY STANDARD APPLIES TO THIS PACKAGE.
- B. DIMENSIONS ARE EXCLUSIVE OF BURRS, MOLD FLASH, AND TIE BAR EXTRUSIONS.
- C. ALL DIMENSIONS ARE IN MILLIMETERS.
- D. DRAWING CONFORMS TO ASME Y14.5-2009.

FGH4L50T65SQD

ON Semiconductor and  are trademarks of Semiconductor Components Industries, LLC dba ON Semiconductor or its subsidiaries in the United States and/or other countries. ON Semiconductor owns the rights to a number of patents, trademarks, copyrights, trade secrets, and other intellectual property. A listing of ON Semiconductor's product/patent coverage may be accessed at www.onsemi.com/site/pdf/Patent-Marking.pdf. ON Semiconductor reserves the right to make changes without further notice to any products herein. ON Semiconductor makes no warranty, representation or guarantee regarding the suitability of its products for any particular purpose, nor does ON Semiconductor assume any liability arising out of the application or use of any product or circuit, and specifically disclaims any and all liability, including without limitation special, consequential or incidental damages. Buyer is responsible for its products and applications using ON Semiconductor products, including compliance with all laws, regulations and safety requirements or standards, regardless of any support or applications information provided by ON Semiconductor. "Typical" parameters which may be provided in ON Semiconductor data sheets and/or specifications can and do vary in different applications and actual performance may vary over time. All operating parameters, including "Typicals" must be validated for each customer application by customer's technical experts. ON Semiconductor does not convey any license under its patent rights nor the rights of others. ON Semiconductor products are not designed, intended, or authorized for use as a critical component in life support systems or any FDA Class 3 medical devices or medical devices with a same or similar classification in a foreign jurisdiction or any devices intended for implantation in the human body. Should Buyer purchase or use ON Semiconductor products for any such unintended or unauthorized application, Buyer shall indemnify and hold ON Semiconductor and its officers, employees, subsidiaries, affiliates, and distributors harmless against all claims, costs, damages, and expenses, and reasonable attorney fees arising out of, directly or indirectly, any claim of personal injury or death associated with such unintended or unauthorized use, even if such claim alleges that ON Semiconductor was negligent regarding the design or manufacture of the part. ON Semiconductor is an Equal Opportunity/Affirmative Action Employer. This literature is subject to all applicable copyright laws and is not for resale in any manner.

PUBLICATION ORDERING INFORMATION

LITERATURE FULFILLMENT:

Email Requests to: orderlit@onsemi.com

ON Semiconductor Website: www.onsemi.com

TECHNICAL SUPPORT

North American Technical Support:
Voice Mail: 1 800-282-9855 Toll Free USA/Canada
Phone: 011 421 33 790 2910

Europe, Middle East and Africa Technical Support:
Phone: 00421 33 790 2910

For additional information, please contact your local Sales Representative