

MOSFET – Dual, N-Channel, Shielded Gate, POWERTRENCH®

100 V, 39 A, 10.5 mΩ

FDMD86100

General Description

This package integrates two N-Channel devices connected internally in common-source configuration and incorporates Shielded Gate technology. This enables very low package parasitics and optimized thermal path to the common source pad on the bottom. Provides a very small footprint (5 x 6 mm) for higher power density.

Features

- Common Source Configuration to Eliminate PCB Routing
- Large Source Pad on Bottom of Package for Enhanced Thermals
- Shielded Gate MOSFET Technology
- Max $r_{DS(on)}$ = 10.5 mΩ at $V_{GS} = 10\text{ V}$, $I_D = 10\text{ A}$
- Max $r_{DS(on)}$ = 17.3 mΩ at $V_{GS} = 6\text{ V}$, $I_D = 7.8\text{ A}$
- Ideal for Flexible Layout in Secondary Side Synchronous Rectification
- 100% UIL tested
- This Device is Pb-Free, Halide Free and is RoHS Compliant

Applications

- Isolated DC-DC Synchronous Rectifiers
- Common Ground Load Switches

MOSFET MAXIMUM RATINGS ($T_A = 25^\circ\text{C}$, unless otherwise noted)

Symbol	Parameter	Ratings	Unit
V_{DS}	Drain to Source Voltage	100	V
V_{GS}	Gate to Source Voltage	±20	V
I_D	Drain Current – Continuous $T_C = 25^\circ\text{C}$ (Note 5) – Continuous $T_C = 100^\circ\text{C}$ (Note 5) – Continuous $T_A = 25^\circ\text{C}$ (Note 1a) – Pulsed (Note 4)	39 24 10 299	A
E_{AS}	Single Pulse Avalanche Energy (Note 3)	337	mJ
P_D	Power Dissipation $T_C = 25^\circ\text{C}$ $T_A = 25^\circ\text{C}$ (Note 1a)	33 2.2	W
T_J, T_{STG}	Operating and Storage Junction Temperature Range	-55 to +150	°C

Stresses exceeding those listed in the Maximum Ratings table may damage the device. If any of these limits are exceeded, device functionality should not be assumed, damage may occur and reliability may be affected.

THERMAL CHARACTERISTICS ($T_C = 25^\circ\text{C}$, unless otherwise noted)

Symbol	Parameter	Ratings	Unit
$R_{\theta JC}$	Thermal Resistance, Junction to Case	3.7	°C/W
$R_{\theta JA}$	Thermal Resistance, Junction to Ambient (Note 1a)	55	

V_{DS}	$r_{DS(on)}$ MAX	I_D MAX
100 V	10.5 mΩ @ 10 V	39 A
	17.3 mΩ @ 6 V	

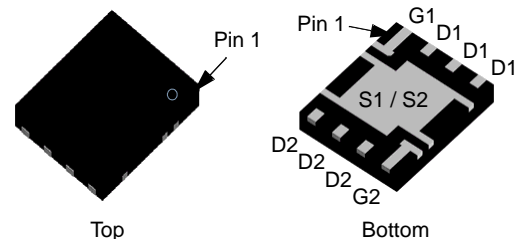

QFN8 5X6, 1.27P
(Power 5 x 6)
CASE 483AS

MARKING DIAGRAM

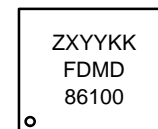

ZZ = Assembly Site Code
X = Year Code
YY = Weekly Code
KK = Lot Code
FDMD86100 = Device Code

PIN ASSIGNMENT

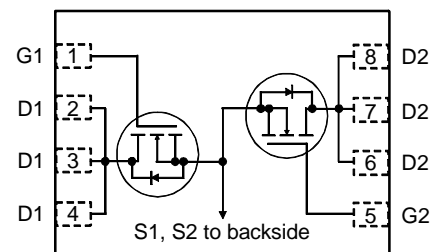

ORDERING INFORMATION

See detailed ordering and shipping information on page 5 of this data sheet.

FDMD86100

ELECTRICAL CHARACTERISTICS (T_J = 25°C unless otherwise noted)

Symbol	Parameter	Test Condition	Min	Typ	Max	Unit
--------	-----------	----------------	-----	-----	-----	------

OFF CHARACTERISTICS

B _V DSS	Drain to Source Breakdown Voltage	I _D = 250 μA, V _{GS} = 0 V	100	–	–	V
$\frac{\Delta B_{V_{DSS}}}{\Delta T_J}$	Breakdown Voltage Temperature Coefficient	I _D = 250 μA, referenced to 25°C	–	7	–	mV/°C
I _{DSS}	Zero Gate Voltage Drain Current	V _{DS} = 80 V, V _{GS} = 0 V	–	–	1	μA
I _{GSS}	Gate to Source Leakage Current	V _{GS} = ±20 V, V _{DS} = 0 V	–	–	±100	nA

ON CHARACTERISTICS

V _{GS(th)}	Gate to Source Threshold Voltage	V _{GS} = V _{DS} , I _D = 250 μA	2.0	3.0	4.0	V
$\frac{\Delta V_{GS(th)}}{\Delta T_J}$	Gate to Source Threshold Voltage Temperature Coefficient	I _D = 250 μA, referenced to 25°C	–	–10	–	mV/°C
r _{DS(on)}	Static Drain to Source On Resistance	V _{GS} = 10 V, I _D = 10 A	–	7.8	10.5	mΩ
		V _{GS} = 6 V, I _D = 7.8 A	–	12	17.3	
		V _{GS} = 10 V, I _D = 10 A, T _J = 125°C	–	14.5	19.5	
g _{FS}	Forward Transconductance	V _{DD} = 5 V, I _D = 10 A	–	26	–	S

DYNAMIC CHARACTERISTICS

C _{iss}	Input Capacitance	V _{DS} = 50 V, V _{GS} = 0 V, f = 1 MHz	–	1469	2060	pF
C _{oss}	Output Capacitance		–	321	450	pF
C _{rss}	Reverse Transfer Capacitance		–	12	20	pF
R _g	Gate Resistance		0.1	1.3	3.3	Ω

SWITCHING CHARACTERISTICS

t _{d(on)}	Turn-On Delay Time	V _{DD} = 50 V, I _D = 10 A, V _{GS} = 10 V, R _{GEN} = 6 Ω	–	13	23	ns
t _r	Rise Time		–	4.3	10	ns
t _{d(off)}	Turn-Off Delay Time		–	18	32	ns
t _f	Fall Time		–	4.1	10	ns
Q _{g(TOT)}	Total Gate Charge		V _{GS} = 0 V to 10 V, V _{DD} = 50 V, I _D = 10 A	–	21	30
	Total Gate Charge	V _{GS} = 0 V to 6 V, V _{DD} = 50 V, I _D = 10 A	–	13	18	nC
Q _{gs}	Gate to Source Charge	V _{DD} = 50 V, I _D = 10 A	–	6.6	–	nC
Q _{gd}	Gate to Drain "Miller" Charge		–	4.1	–	nC

DRAIN-SOURCE CHARACTERISTICS

V _{SD}	Source to Drain Diode Forward Voltage	V _{GS} = 0 V, I _S = 10 A (Note 2)	–	0.8	1.3	V
		V _{GS} = 0 V, I _S = 2 A (Note 2)	–	0.7	1.2	
t _{rr}	Reverse Recovery Time	I _F = 10 A, di/dt = 100 A/μs	–	46	74	ns
Q _{rr}	Reverse Recovery Charge		–	46	74	nC

Product parametric performance is indicated in the Electrical Characteristics for the listed test conditions, unless otherwise noted. Product performance may not be indicated by the Electrical Characteristics if operated under different conditions.

- R_{θJA} is determined with the device mounted on a 1 in² pad 2 oz copper pad on a 1.5 x 1.5 in. board of FR-4 material. R_{θCA} is determined by the user's board design.

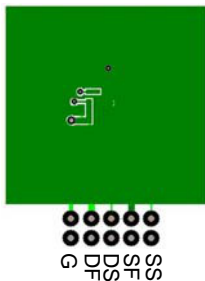

a. 55°C/W when mounted on a 1 in² pad of 2 oz copper

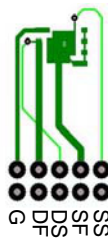

b. 125°C/W when mounted on a minimum pad of 2 oz copper

- Pulse Test: Pulse Width < 300 μs, Duty cycle < 2.0%.
- E_{AS} of 337 mJ is based on starting T_J = 25°C, L = 3 mH, I_{AS} = 15 A, V_{DD} = 100 V, V_{GS} = 10 V. 100% tested at L = 0.1 mH, I_{AS} = 47 A.
- Pulse I_d refers to Figure 11 SOA graph for details.
- Computed continuous current limited to Max Junction Temperature only, actual continuous current will be limited by thermal & electro-mechanical application board design.

TYPICAL CHARACTERISTICS ($T_J = 25^\circ\text{C}$, unless otherwise noted)

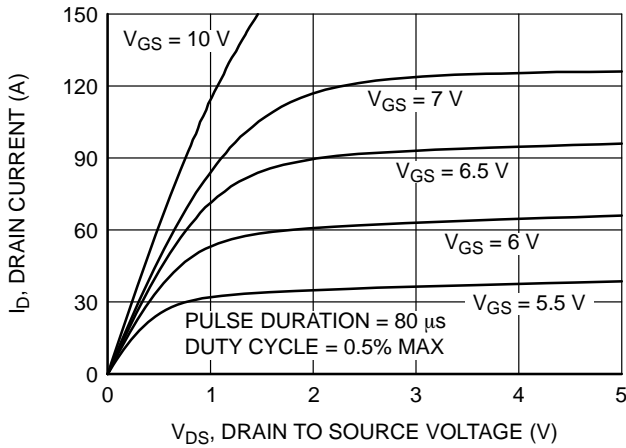

Figure 1. On-Region Characteristics

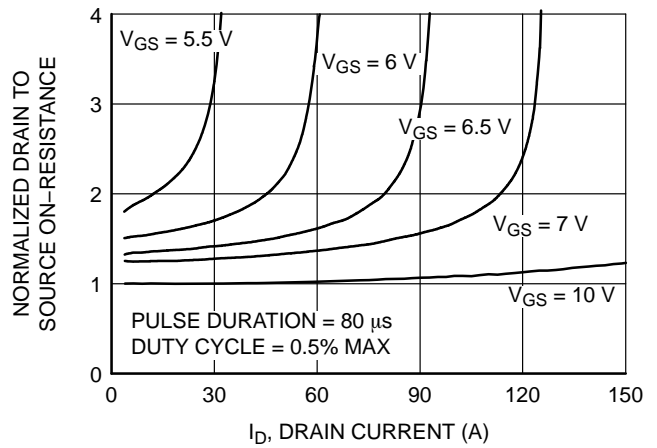

Figure 2. Normalized On-Resistance vs. Drain Current and Gate Voltage

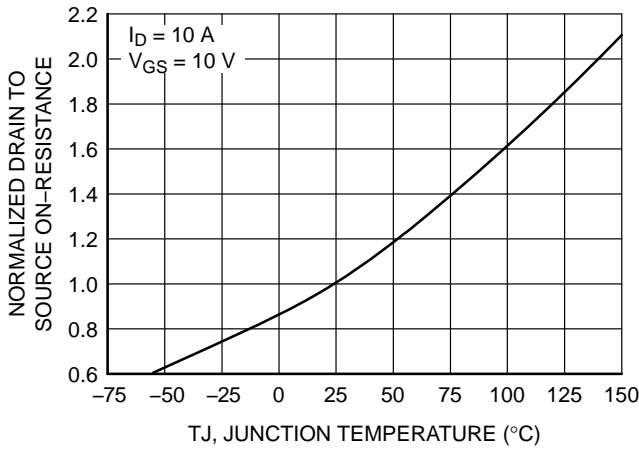

Figure 3. Normalized On-Resistance vs. Junction Temperature

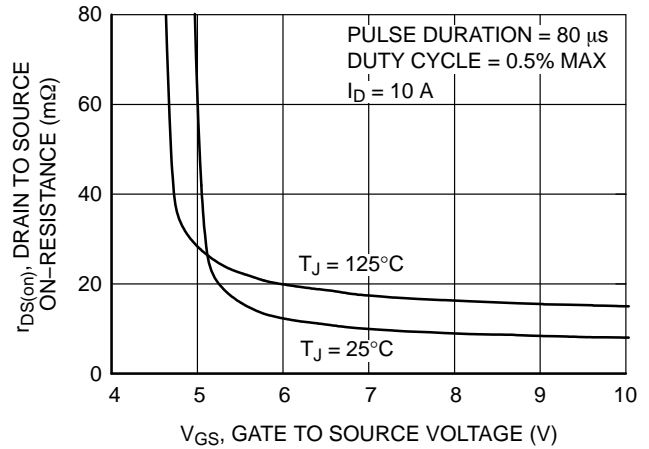

Figure 4. On-Resistance vs. Gate to Source Voltage

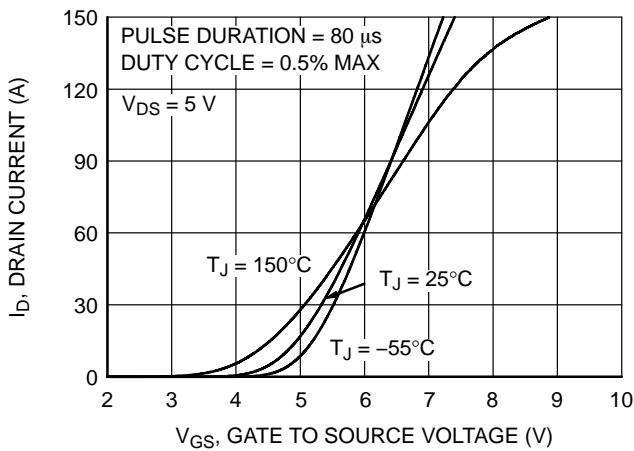

Figure 5. Transfer Characteristics

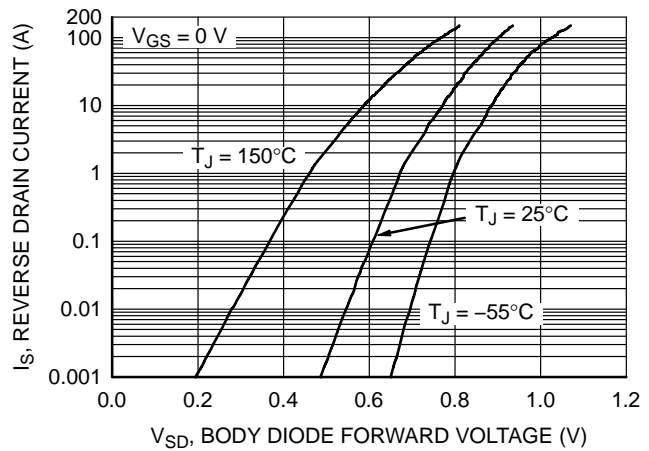

Figure 6. Source to Drain Diode Forward Voltage vs. Source Current

TYPICAL CHARACTERISTICS ($T_J = 25^\circ\text{C}$, unless otherwise noted) (continued)

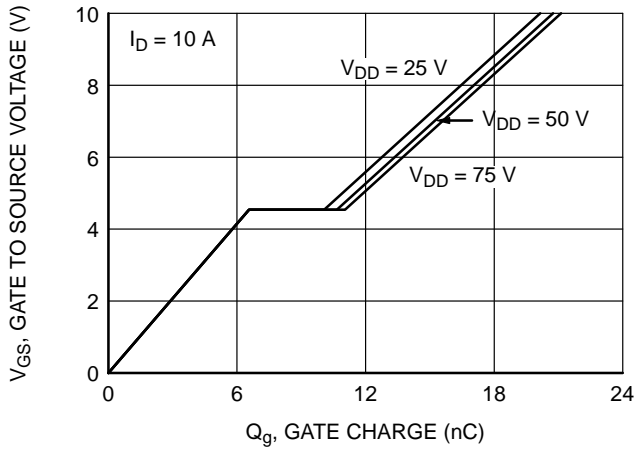

Figure 7. Gate Charge Characteristics

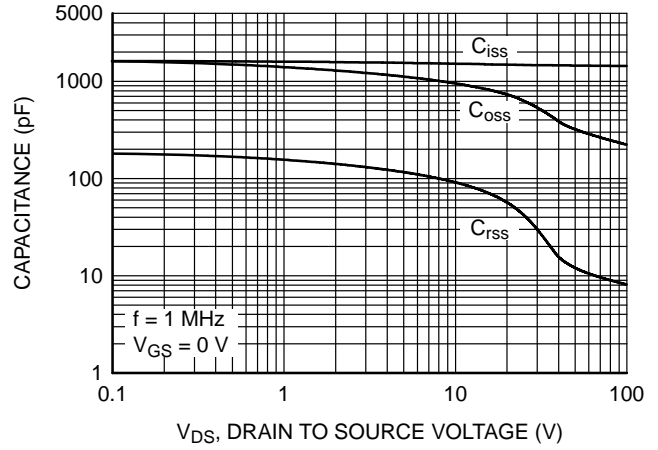

Figure 8. Capacitance vs. Drain to Source Voltage

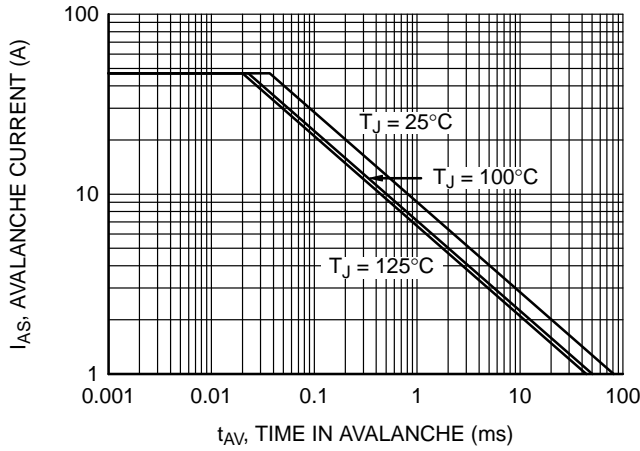

Figure 9. Unclamped Inductive Switching Capability

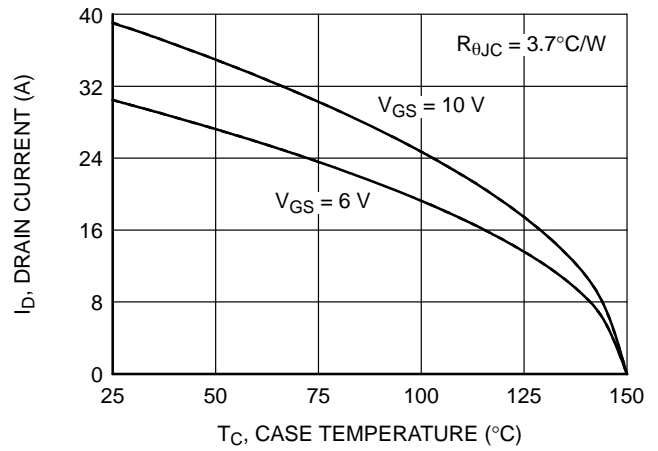

Figure 10. Maximum Continuous Drain Current vs. Case Temperature

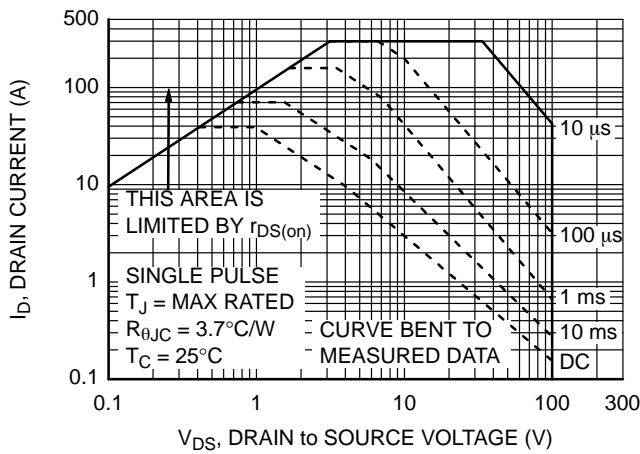

Figure 11. Forward Bias Safe Operating Area

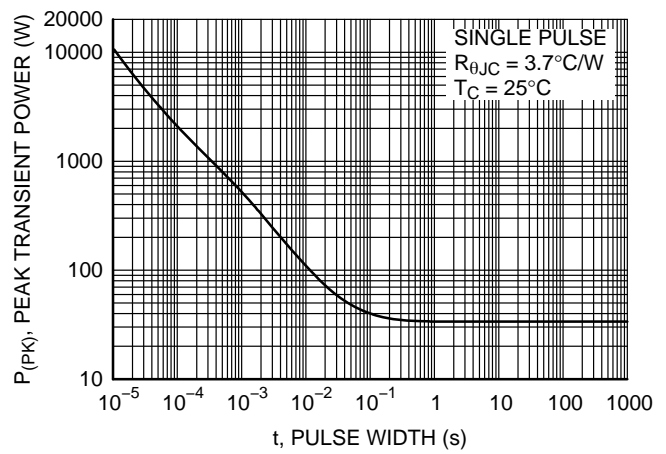

Figure 12. Single Pulse Maximum Power Dissipation

FDMD86100

TYPICAL CHARACTERISTICS ($T_J = 25^\circ\text{C}$, unless otherwise noted) (continued)

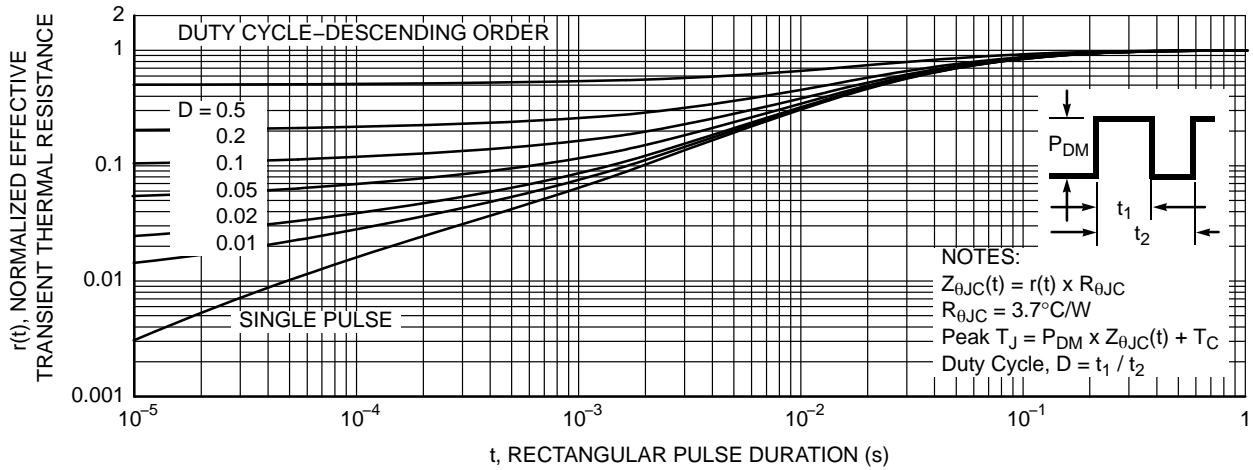

Figure 13. Junction-to-Case Transient Thermal Response Curve

PACKAGE MARKING AND ORDERING INFORMATION

Device	Device Marking	Package	Reel Size	Tape Width	Shipping†
FDMD86100	FDMD86100	PQFN8 5X6, 1.27P (Power 5 x 6) (Pb-Free, Halide Free)	13"	12 mm	3000 / Tape & Reel

†For information on tape and reel specifications, including part orientation and tape sizes, please refer to our Tape and Reel Packaging Specifications Brochure, BRD8011/D.

MECHANICAL CASE OUTLINE

PACKAGE DIMENSIONS

ON Semiconductor®

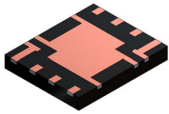

PQFN8 5X6, 1.27P CASE 483AS ISSUE A

DATE 17 MAY 2021

NOTES:

- A) PACKAGE REFERENCE :
TO JEDEC REGISTRATION, MO-240B, VARIATION AA.
- B) ALL DIMENSIONS ARE IN MILLIMETERS.
- C) DIMENSIONS DO NOT INCLUDE BURRS OR MOLD FLASH.
MOLD FLASH OR BURRS DOES NOT EXCEED 0.10MM.
- D) DIMENSIONING AND TOLERANCING PER ASME
Y14.5M-2009
- E) IT IS RECOMMENDED TO HAVE NO
TRACES OR VIAS WITHIN THE KEEP-OUT AREA

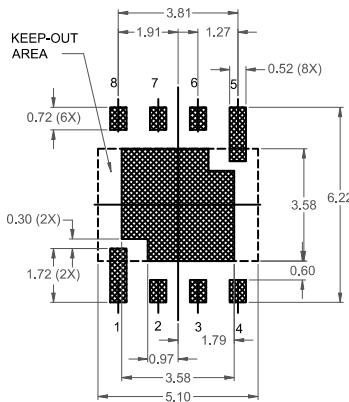
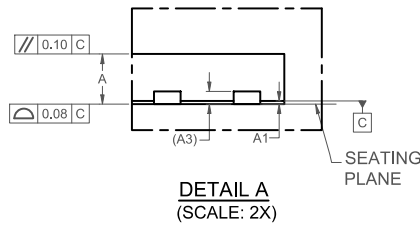
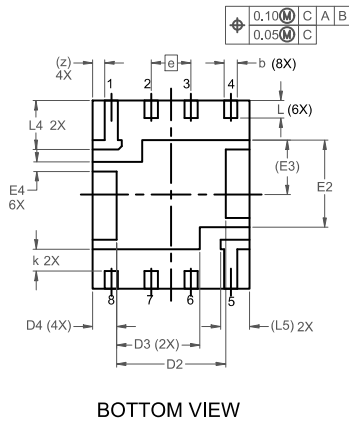
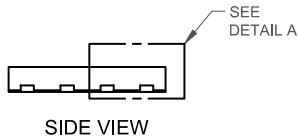
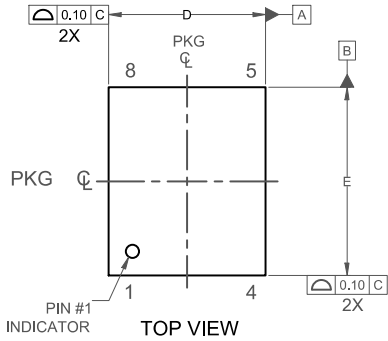

*FOR ADDITIONAL INFORMATION ON OUR
PB-FREE STRATEGY AND SOLDERING
DETAILS, PLEASE DOWNLOAD THE ON
SEMICONDUCTOR SOLDERING AND
MOUNTING TECHNIQUES REFERENCE
MANUAL, SOLDERRM/D.

DIM	MILLIMETERS		
	MIN.	NOM.	MAX.
A	0.70	0.75	0.80
A1	0.00	-	0.05
b	0.37	0.42	0.47
A3	0.20 REF		
D	4.90	5.00	5.10
D2	3.38	3.48	3.58
D3	2.55	2.65	2.75
D4	0.66	0.76	0.86
E	5.90	6.00	6.10
E2	2.68	2.78	2.88
E3	1.74 REF		
E4	0.25	0.30	0.35
e	1.27 BSC		
k	0.60	0.70	0.80
L	0.46	0.56	0.66
L4	1.46	1.56	1.66
L5	0.82	0.92	1.02
z	0.39 REF		

DOCUMENT NUMBER:	98AON13667G	Electronic versions are uncontrolled except when accessed directly from the Document Repository. Printed versions are uncontrolled except when stamped "CONTROLLED COPY" in red.
DESCRIPTION:	PQFN8 5X6, 1.27P	PAGE 1 OF 1

ON Semiconductor and are trademarks of Semiconductor Components Industries, LLC dba ON Semiconductor or its subsidiaries in the United States and/or other countries. ON Semiconductor reserves the right to make changes without further notice to any products herein. ON Semiconductor makes no warranty, representation or guarantee regarding the suitability of its products for any particular purpose, nor does ON Semiconductor assume any liability arising out of the application or use of any product or circuit, and specifically disclaims any and all liability, including without limitation special, consequential or incidental damages. ON Semiconductor does not convey any license under its patent rights nor the rights of others.

onsemi, **Onsemi**, and other names, marks, and brands are registered and/or common law trademarks of Semiconductor Components Industries, LLC dba "**onsemi**" or its affiliates and/or subsidiaries in the United States and/or other countries. **onsemi** owns the rights to a number of patents, trademarks, copyrights, trade secrets, and other intellectual property. A listing of **onsemi**'s product/patent coverage may be accessed at www.onsemi.com/site/pdf/Patent-Marking.pdf. **onsemi** reserves the right to make changes at any time to any products or information herein, without notice. The information herein is provided "as-is" and **onsemi** makes no warranty, representation or guarantee regarding the accuracy of the information, product features, availability, functionality, or suitability of its products for any particular purpose, nor does **onsemi** assume any liability arising out of the application or use of any product or circuit, and specifically disclaims any and all liability, including without limitation special, consequential or incidental damages. Buyer is responsible for its products and applications using **onsemi** products, including compliance with all laws, regulations and safety requirements or standards, regardless of any support or applications information provided by **onsemi**. "Typical" parameters which may be provided in **onsemi** data sheets and/or specifications can and do vary in different applications and actual performance may vary over time. All operating parameters, including "Typicals" must be validated for each customer application by customer's technical experts. **onsemi** does not convey any license under any of its intellectual property rights nor the rights of others. **onsemi** products are not designed, intended, or authorized for use as a critical component in life support systems or any FDA Class 3 medical devices or medical devices with a same or similar classification in a foreign jurisdiction or any devices intended for implantation in the human body. Should Buyer purchase or use **onsemi** products for any such unintended or unauthorized application, Buyer shall indemnify and hold **onsemi** and its officers, employees, subsidiaries, affiliates, and distributors harmless against all claims, costs, damages, and expenses, and reasonable attorney fees arising out of, directly or indirectly, any claim of personal injury or death associated with such unintended or unauthorized use, even if such claim alleges that **onsemi** was negligent regarding the design or manufacture of the part. **onsemi** is an Equal Opportunity/Affirmative Action Employer. This literature is subject to all applicable copyright laws and is not for resale in any manner.

PUBLICATION ORDERING INFORMATION

LITERATURE FULFILLMENT:

Email Requests to: orderlit@onsemi.com

onsemi Website: www.onsemi.com

TECHNICAL SUPPORT

North American Technical Support:

Voice Mail: 1 800-282-9855 Toll Free USA/Canada

Phone: 011 421 33 790 2910

Europe, Middle East and Africa Technical Support:

Phone: 00421 33 790 2910

For additional information, please contact your local Sales Representative