

MOSFET – N-Channel, POWERTRENCH®

80 V, 20 A, 23 mΩ

FDMC86324

General Description

This N-Channel MOSFET is produced using onsemi's advanced POWERTRENCH process that has been especially tailored to minimize the on-state resistance and yet maintain superior switching performance.

Features

- Max $R_{DS(on)}$ = 23 mΩ at $V_{GS} = 10$ V, $I_D = 7$ A
- Max $R_{DS(on)}$ = 37 mΩ at $V_{GS} = 6$ V, $I_D = 4$ A
- Low Profile – 1 mm Max in Power 33
- 100% UIL Tested
- Pb-Free, Halide Free and RoHS Compliant

Applications

- DC-DC Conversion

ABSOLUTE MAXIMUM RATINGS ($T_A = 25^\circ\text{C}$ unless otherwise noted.)

| Symbol | Parameter | Value | Unit |
|----------------|---------------------------------------------------------|-------------|------------------|
| V_{DS} | Drain-Source Voltage | 80 | V |
| V_{GS} | Gate-Source Voltage | ± 20 | V |
| I_D | Drain Current | | A |
| | – Continuous (Package Limited) $T_C = 25^\circ\text{C}$ | 20 | |
| | – Continuous (Silicon Limited) $T_C = 25^\circ\text{C}$ | 30 | |
| | – Continuous (Note 1a) $T_A = 25^\circ\text{C}$ | 7 | |
| | – Pulsed | 30 | |
| E_{AS} | Single Pulse Avalanche Energy (Note 3) | 72 | mJ |
| P_D | Power Dissipation $T_C = 25^\circ\text{C}$ | 41 | W |
| | Power Dissipation (Note 1a) $T_A = 25^\circ\text{C}$ | 2.3 | |
| T_J, T_{STG} | Operating and Storage Junction Temperature Range | -55 to +150 | $^\circ\text{C}$ |

Stresses exceeding those listed in the Maximum Ratings table may damage the device. If any of these limits are exceeded, device functionality should not be assumed, damage may occur and reliability may be affected.

THERMAL CHARACTERISTICS ($T_A = 25^\circ\text{C}$ unless otherwise noted.)

| Symbol | Parameter | Value | Unit |
|-----------------|---------------------------------------------------|-------|---------------------------|
| $R_{\theta JC}$ | Thermal Resistance, Junction to Case | 3 | $^\circ\text{C}/\text{W}$ |
| $R_{\theta JA}$ | Thermal Resistance, Junction to Ambient (Note 1a) | 53 | $^\circ\text{C}/\text{W}$ |

| V_{DS} | $R_{DS(on)}$ MAX | I_D MAX |
|----------|------------------|-----------|
| 80 V | 23 mΩ @ 10 V | 20 A |
| | 37 mΩ @ 6 V | |

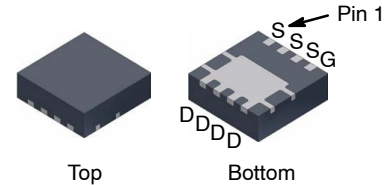

PQFN8 3.3 × 3.3, 0.65P
CASE 483AK

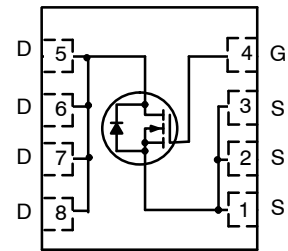

N-CHANNEL MOSFET

MARKING DIAGRAM

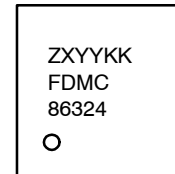

Z = Assembly Plant Code
 XYY = 3-Digit Date Code Format
 KK = 2-Alphanumeric Lot Run Traceability Code
 FDMC86324 = Specific Device Code

ORDERING INFORMATION

| Device | Package | Shipping† |
|-----------|------------------------------|--------------------|
| FDMC86324 | PQFN8 (Pb-Free, Halide Free) | 3000 / Tape & Reel |

†For information on tape and reel specifications, including part orientation and tape sizes, please refer to our Tape and Reel Packaging Specification Brochure, [BRD8011/D](#).

FDMC86324

ELECTRICAL CHARACTERISTICS (T_J = 25°C unless otherwise noted)

| Symbol | Parameter | Test Condition | Min | Typ | Max | Unit |
|--------|-----------|----------------|-----|-----|-----|------|
|--------|-----------|----------------|-----|-----|-----|------|

OFF CHARACTERISTICS

| | | | | | | |
|-------------------------------------|-------------------------------------------|------------------------------------------------|----|----|------|-------|
| BV _{DSS} | Drain to Source Breakdown Voltage | I _D = 250 μA, V _{GS} = 0 V | 80 | – | – | V |
| ΔBV _{DSS} /ΔT _J | Breakdown Voltage Temperature Coefficient | I _D = 250 μA, referenced to 25°C | – | 69 | – | mV/°C |
| I _{DSS} | Zero Gate Voltage Drain Current | V _{DS} = 64 V, V _{GS} = 0 V | – | – | 1 | μA |
| I _{GSS} | Gate to Source Leakage Current | V _{GS} = ±20 V, V _{DS} = 0 V | – | – | ±100 | nA |

ON CHARACTERISTICS

| | | | | | | |
|---------------------------------------|----------------------------------------------------------|----------------------------------------------------------------------|-----|------|-----|-------|
| V _{GS(th)} | Gate to Source Threshold Voltage | V _{GS} = V _{DS} , I _D = 250 μA | 2.0 | 3.1 | 4.0 | V |
| ΔV _{GS(th)} /ΔT _J | Gate to Source Threshold Voltage Temperature Coefficient | I _D = 250 μA, referenced to 25°C | – | –9 | – | mV/°C |
| R _{DS(on)} | Static Drain to Source On Resistance | V _{GS} = 10 V, I _D = 7 A | – | 19.1 | 23 | mΩ |
| | | V _{GS} = 6 V, I _D = 4 A | – | 25.5 | 37 | |
| | | V _{GS} = 10 V, I _D = 7 A, T _J = 125°C | – | 32.5 | 40 | |
| g _{FS} | Forward Transconductance | V _{DD} = 10 V, I _D = 7 A | – | 19 | – | S |

DYNAMIC CHARACTERISTICS

| | | | | | | |
|------------------|------------------------------|----------------------------------------------------------|---|-----|-----|----|
| C _{iss} | Input Capacitance | V _{DS} = 50 V, V _{GS} = 0 V, f = 1 MHz | – | 725 | 965 | pF |
| C _{oss} | Output Capacitance | | – | 175 | 235 | pF |
| C _{rss} | Reverse Transfer Capacitance | | – | 15 | 25 | pF |
| R _g | Gate Resistance | | – | 0.5 | – | Ω |

SWITCHING CHARACTERISTICS

| | | | | | | |
|---------------------|-------------------------------|----------------------------------------------------------------------------------------------|---|-----|----|----|
| t _{d(on)} | Turn-On Delay Time | V _{DD} = 50 V, I _D = 7 A, V _{GS} = 10 V, R _{GEN} = 6 Ω | – | 8 | 17 | ns |
| t _r | Rise Time | | – | 4 | 10 | ns |
| t _{d(off)} | Turn-Off Delay Time | | – | 14 | 25 | ns |
| t _f | Fall Time | | – | 4 | 10 | ns |
| Q _{g(TOT)} | Total Gate Charge | V _{GS} = 0 V to 10 V, V _{DD} = 50 V, I _D = 7 A | – | 13 | 18 | nC |
| | | V _{GS} = 0 V to 5 V, V _{DD} = 50 V, I _D = 7 A | – | 8 | 11 | nC |
| Q _{gs} | Gate to Source Charge | V _{DD} = 50 V, I _D = 7 A | – | 3.7 | – | nC |
| Q _{gd} | Gate to Drain "Miller" Charge | V _{DD} = 50 V, I _D = 7 A | – | 3.6 | – | nC |

DRAIN-SOURCE DIODE CHARACTERISTICS

| | | | | | | |
|-----------------|---------------------------------------|------------------------------------------------------|---|------|-----|----|
| V _{SD} | Source to Drain Diode Forward Voltage | V _{GS} = 0 V, I _S = 7 A (Note 2) | – | 0.81 | 1.3 | V |
| | | V _{GS} = 0 V, I _S = 2 A (Note 2) | – | 0.75 | 1.2 | |
| t _{rr} | Reverse Recovery Time | I _F = 7 A, di/dt = 100 A/μs | – | 44 | 70 | ns |
| Q _{rr} | Reverse Recovery Charge | | – | 40 | 65 | nC |

Product parametric performance is indicated in the Electrical Characteristics for the listed test conditions, unless otherwise noted. Product performance may not be indicated by the Electrical Characteristics if operated under different conditions.

NOTES:

- R_{θJA} is determined with the device mounted on a 1 in² pad 2 oz copper pad on a 1.5 × 1.5 in. board of FR-4 material. R_{θJC} is guaranteed by design while R_{θCA} is determined by the user's board design.

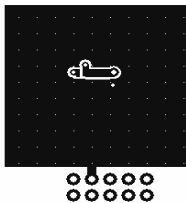

- a) 53°C/W when mounted on a 1 in² pad of 2 oz. copper.

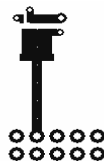

- b) 125°C/W when mounted on a minimum pad of 2 oz. copper.

- Pulse Test: Pulse Width < 300 μs, Duty cycle < 2.0%.
- Starting T_J = 25°C; N-ch: L = 1 mH, I_{AS} = 12 A, V_{DD} = 72 V, V_{GS} = 10 V.

TYPICAL CHARACTERISTICS

($T_J = 25^\circ\text{C}$ unless otherwise noted)

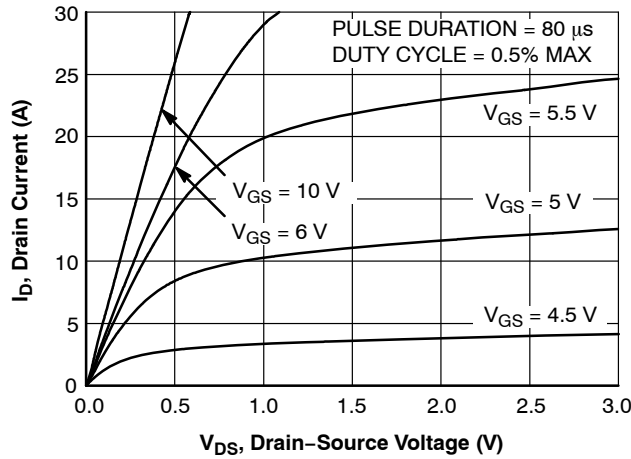

Figure 1. On-Region Characteristics

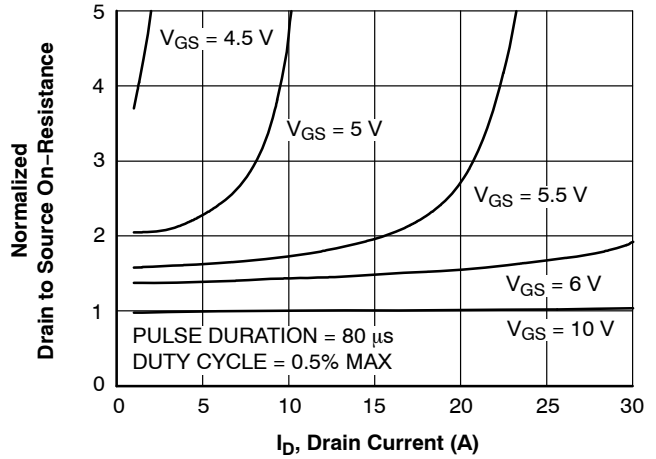

Figure 2. Normalized On-Resistance vs. Drain Current and Gate Voltage

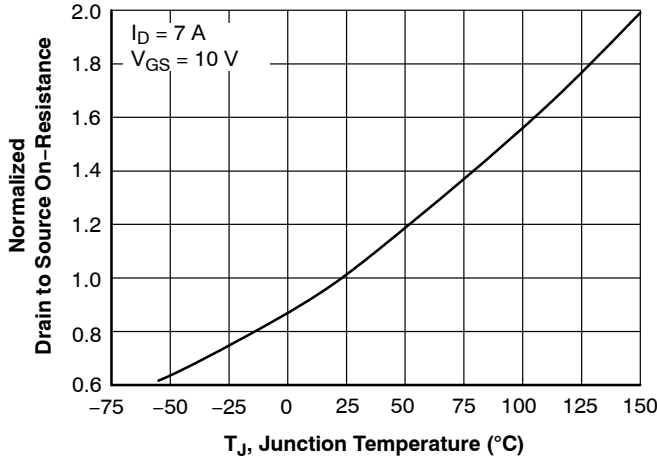

Figure 3. Normalized On-Resistance vs. Junction Temperature

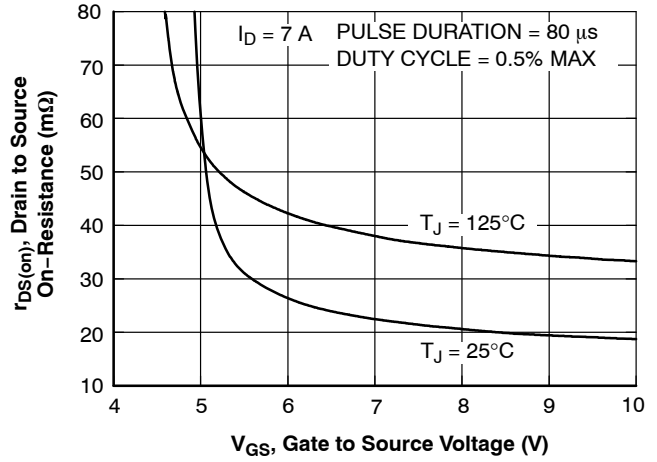

Figure 4. On-Resistance vs. Gate to Source Voltage

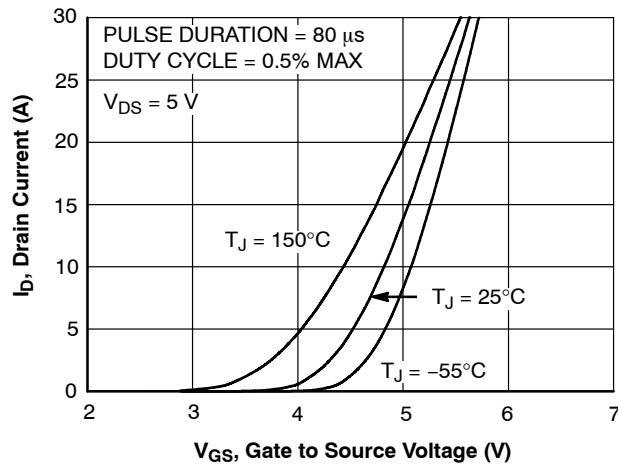

Figure 5. Transfer Characteristics

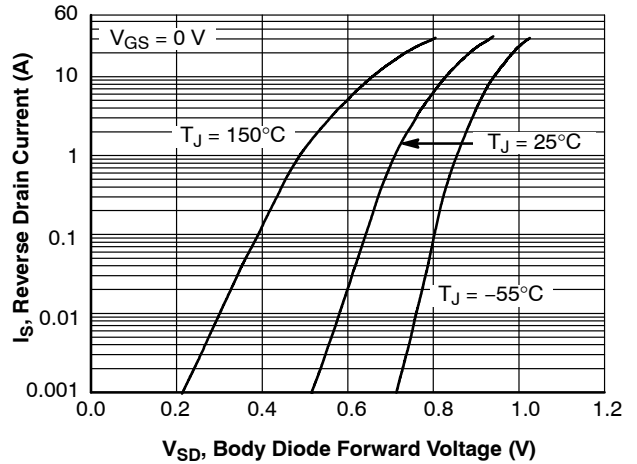

Figure 6. Source to Drain Diode Forward Voltage vs. Source Current

TYPICAL CHARACTERISTICS (CONTINUED)

($T_J = 25^\circ\text{C}$ unless otherwise noted)

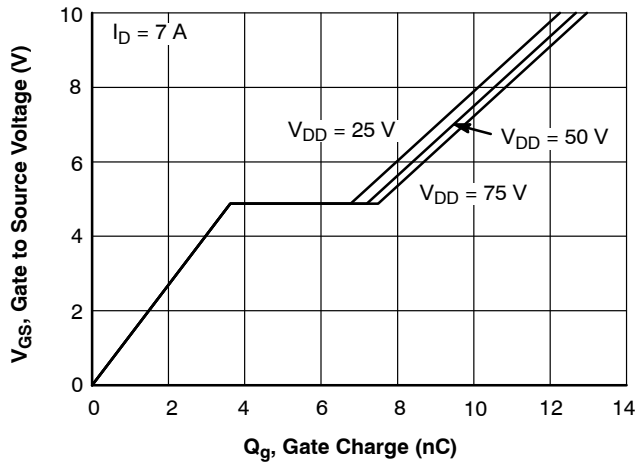

Figure 7. Gate Charge Characteristics

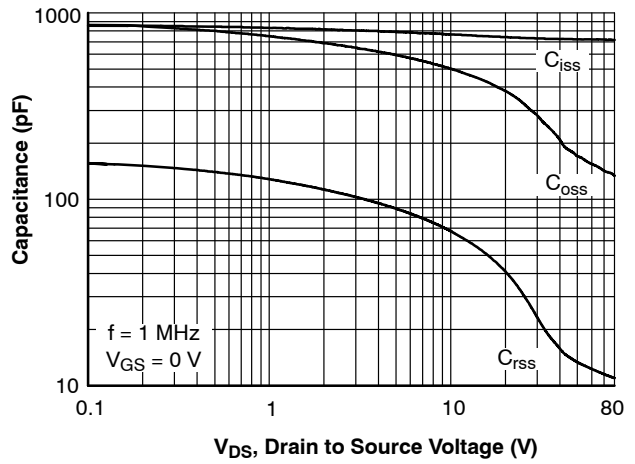

Figure 8. Capacitance vs. Drain to Source Voltage

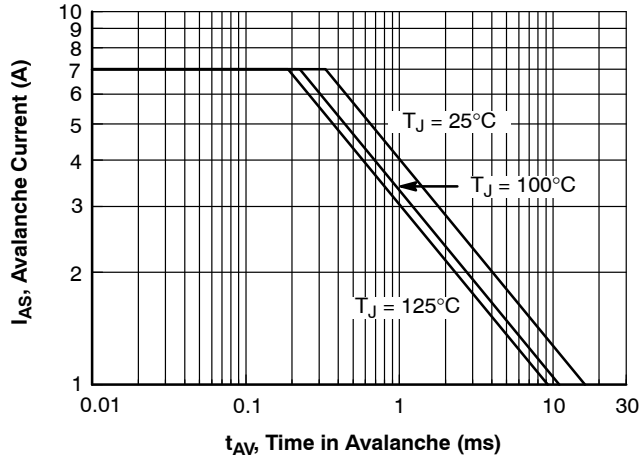

Figure 9. Unclamped Inductive Switching Capability

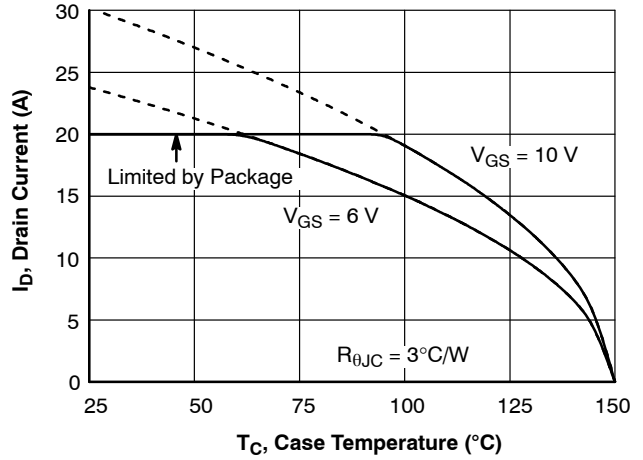

Figure 10. Maximum Continuous Drain Current vs. Case Temperature

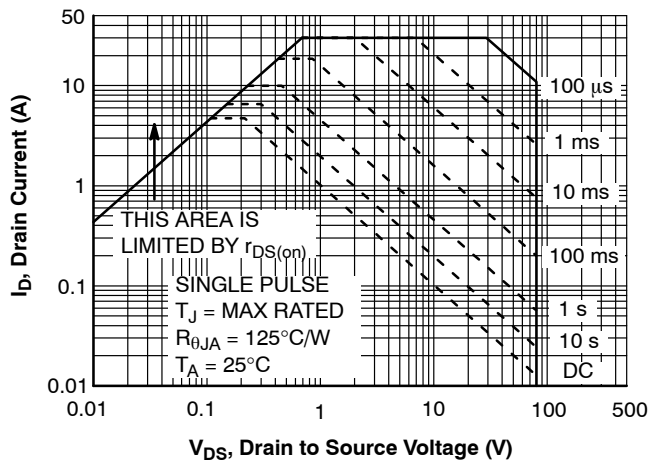

Figure 11. Forward Bias Safe Operating Area

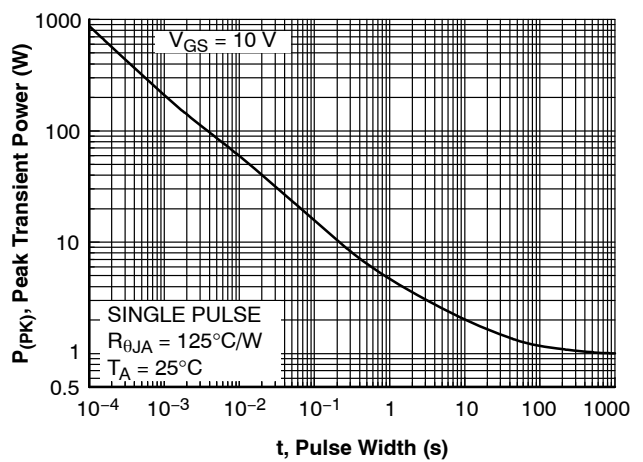

Figure 12. Single Pulse Maximum Power Dissipation

TYPICAL CHARACTERISTICS (CONTINUED)

($T_J = 25^\circ\text{C}$ unless otherwise noted)

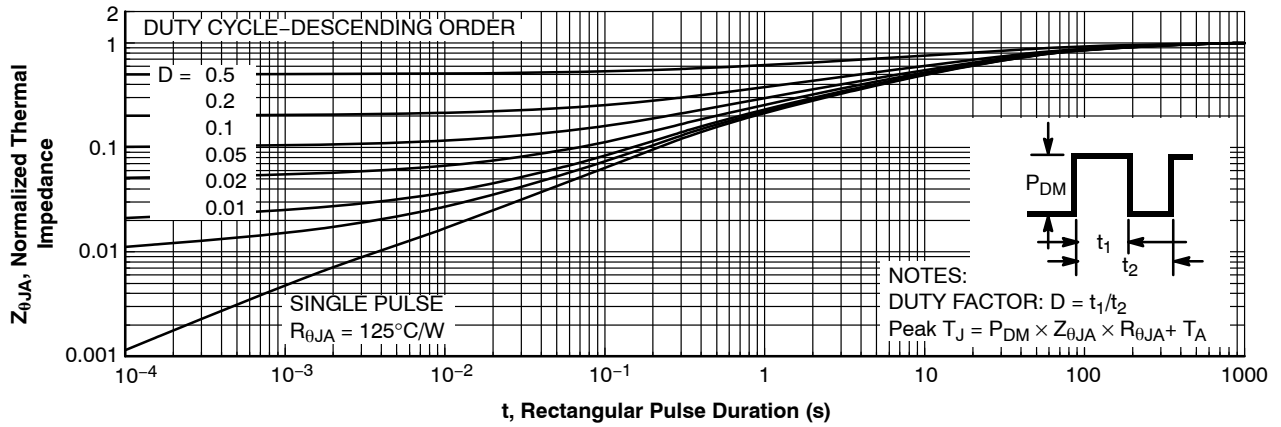
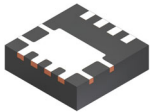

Figure 13. Junction-to-Ambient Transient Thermal Response Curve



PQFN8 3.3X3.3, 0.65P
CASE 483AK
ISSUE B

DATE 12 OCT 2021



TOP VIEW

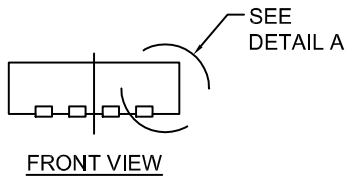

FRONT VIEW

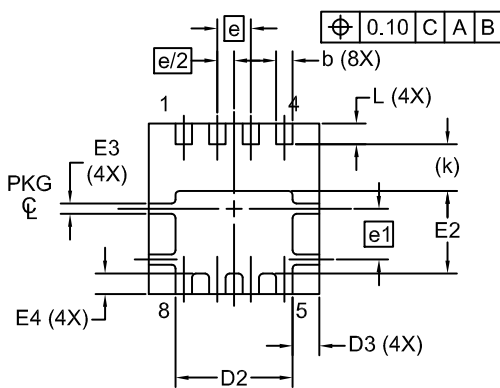

BOTTOM VIEW

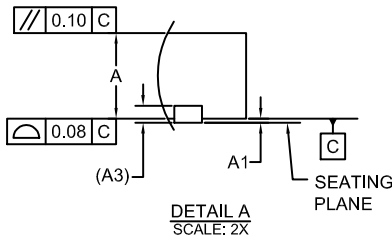

DETAIL A
SCALE: 2X

NOTES:

1. DIMENSIONING AND TOLERANCING PER ASME Y14.5M, 2009.
2. CONTROLLING DIMENSION: MILLIMETERS
3. COPLANARITY APPLIES TO THE EXPOSED PADS AS WELL AS THE TERMINALS.
4. DIMENSIONS D1 AND E1 DO NOT INCLUDE MOLD FLASH, PROTRUSIONS, OR GATE BURRS.
5. SEATING PLANE IS DEFINED BY THE TERMINALS. "A1" IS DEFINED AS THE DISTANCE FROM THE SEATING PLANE TO THE LOWEST POINT ON THE PACKAGE BODY.
6. IT IS RECOMMENDED TO HAVE NO TRACES OR VIAS WITHIN THE KEEP OUT AREA.

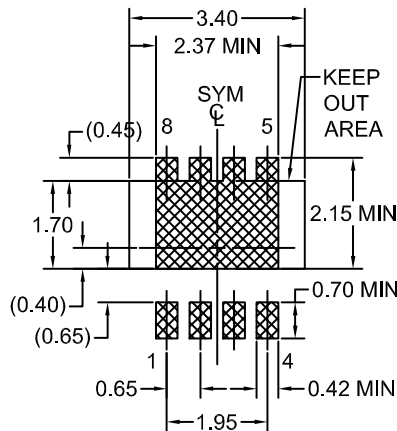

LAND PATTERN
RECOMMENDATION

*FOR ADDITIONAL INFORMATION ON OUR PB-FREE STRATEGY AND SOLDERING DETAILS, PLEASE DOWNLOAD THE ON SEMICONDUCTOR SOLDERING AND MOUNTING TECHNIQUES REFERENCE MANUAL, SOLDERM/D.

| DIM | MILLIMETERS | | |
|-----|-------------|------|------|
| | MIN. | NOM. | MAX. |
| A | 0.90 | 1.00 | 1.10 |
| A1 | 0.00 | - | 0.05 |
| A3 | 0.20 REF | | |
| b | 0.27 | 0.32 | 0.37 |
| D | 3.20 | 3.30 | 3.40 |
| D2 | 2.17 | 2.27 | 2.37 |
| D3 | 0.42 | 0.52 | 0.62 |
| E | 3.20 | 3.30 | 3.40 |
| E2 | 1.50 | 1.60 | 1.70 |
| E3 | 0.10 | 0.20 | 0.30 |
| E4 | 0.29 | 0.39 | 0.49 |
| e | 0.65 BSC | | |
| e/2 | 0.325 BSC | | |
| e1 | 0.98 BSC | | |
| k | 0.91 REF | | |
| L | 0.30 | 0.40 | 0.50 |

| | | |
|------------------|----------------------|----------------------------------------------------------------------------------------------------------------------------------------------------------------------------------|
| DOCUMENT NUMBER: | 98AON13660G | Electronic versions are uncontrolled except when accessed directly from the Document Repository. Printed versions are uncontrolled except when stamped "CONTROLLED COPY" in red. |
| DESCRIPTION: | PQFN8 3.3X3.3, 0.65P | PAGE 1 OF 1 |

onsemi and Onsemi are trademarks of Semiconductor Components Industries, LLC dba onsemi or its subsidiaries in the United States and/or other countries. onsemi reserves the right to make changes without further notice to any products herein. onsemi makes no warranty, representation or guarantee regarding the suitability of its products for any particular purpose, nor does onsemi assume any liability arising out of the application or use of any product or circuit, and specifically disclaims any and all liability, including without limitation special, consequential or incidental damages. onsemi does not convey any license under its patent rights nor the rights of others.

onsemi, **Onsemi**, and other names, marks, and brands are registered and/or common law trademarks of Semiconductor Components Industries, LLC dba "**onsemi**" or its affiliates and/or subsidiaries in the United States and/or other countries. **onsemi** owns the rights to a number of patents, trademarks, copyrights, trade secrets, and other intellectual property. A listing of **onsemi**'s product/patent coverage may be accessed at www.onsemi.com/site/pdf/Patent-Marking.pdf. **onsemi** reserves the right to make changes at any time to any products or information herein, without notice. The information herein is provided "as-is" and **onsemi** makes no warranty, representation or guarantee regarding the accuracy of the information, product features, availability, functionality, or suitability of its products for any particular purpose, nor does **onsemi** assume any liability arising out of the application or use of any product or circuit, and specifically disclaims any and all liability, including without limitation special, consequential or incidental damages. Buyer is responsible for its products and applications using **onsemi** products, including compliance with all laws, regulations and safety requirements or standards, regardless of any support or applications information provided by **onsemi**. "Typical" parameters which may be provided in **onsemi** data sheets and/or specifications can and do vary in different applications and actual performance may vary over time. All operating parameters, including "Typicals" must be validated for each customer application by customer's technical experts. **onsemi** does not convey any license under any of its intellectual property rights nor the rights of others. **onsemi** products are not designed, intended, or authorized for use as a critical component in life support systems or any FDA Class 3 medical devices or medical devices with a same or similar classification in a foreign jurisdiction or any devices intended for implantation in the human body. Should Buyer purchase or use **onsemi** products for any such unintended or unauthorized application, Buyer shall indemnify and hold **onsemi** and its officers, employees, subsidiaries, affiliates, and distributors harmless against all claims, costs, damages, and expenses, and reasonable attorney fees arising out of, directly or indirectly, any claim of personal injury or death associated with such unintended or unauthorized use, even if such claim alleges that **onsemi** was negligent regarding the design or manufacture of the part. **onsemi** is an Equal Opportunity/Affirmative Action Employer. This literature is subject to all applicable copyright laws and is not for resale in any manner.

ADDITIONAL INFORMATION

TECHNICAL PUBLICATIONS:

Technical Library: www.onsemi.com/design/resources/technical-documentation
onsemi Website: www.onsemi.com

ONLINE SUPPORT: www.onsemi.com/support

For additional information, please contact your local Sales Representative at www.onsemi.com/support/sales