

# MOSFET – Dual N-Channel, POWERTRENCH®

40 V, 7 A, 20 mΩ

## FDMC8032L

### General Description

This device includes two 40 V N-Channel MOSFETs in a dual Power 33 (3 mm x 3 mm MLP) package. The package is enhanced for exceptional thermal performance.

### Features

- Max  $r_{DS(on)}$  = 20 mΩ at  $V_{GS} = 10\text{ V}$ ,  $I_D = 7\text{ A}$
- Max  $r_{DS(on)}$  = 27 mΩ at  $V_{GS} = 4.5\text{ V}$ ,  $I_D = 6\text{ A}$
- Low Inductance Packaging Shortens Rise/Fall Times
- Lower Switching Losses
- 100% Rg Tested
- This Device is Pb-Free and is RoHS Compliant

### Applications

- Battery Protection
- Load Switching
- Point of Load

### MOSFET MAXIMUM RATINGS ( $T_A = 25^\circ\text{C}$ unless otherwise noted)

Symbol	Parameter	Ratings	Units
$V_{DS}$	Drain to Source Voltage	40	V
$V_{GS}$	Gate to Source Voltage	$\pm 20$	V
$I_D$	Drain Current – Continuous $T_C = 25^\circ\text{C}$ – Continuous $T_A = 25^\circ\text{C}$ (Note 1a) – Pulsed (Note 4)	20	A
		7	
		50	
$E_{AS}$	Single Pulse Avalanche Energy (Note 3)	13	mJ
$P_D$	Power Dissipation $T_C = 25^\circ\text{C}$	12	W
	Power Dissipation $T_A = 25^\circ\text{C}$ (Note 1a)	1.9	
$T_J, T_{STG}$	Operating and Storage Junction Temperature Range	-55 to +150	$^\circ\text{C}$

Stresses exceeding those listed in the Maximum Ratings table may damage the device. If any of these limits are exceeded, device functionality should not be assumed, damage may occur and reliability may be affected.

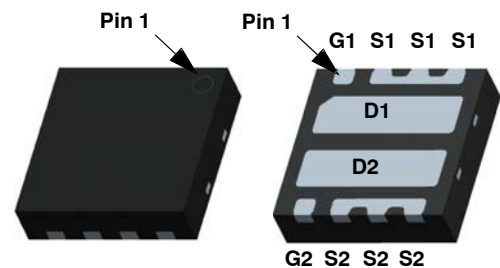
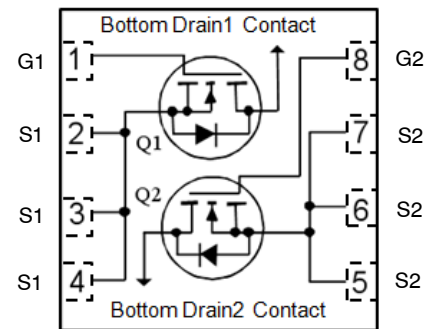

Power 33

WDFN8 3x3, 0.65P  
CASE 511DG

### MARKING DIAGRAM

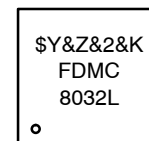

\$Y = onsemi Logo  
&Z = Assembly Plant Code  
&2 = Numeric Date Code  
&K = Lot Code  
FDMC8032L = Specific Device Code

### ORDERING INFORMATION

See detailed ordering and shipping information on page 2 of this data sheet.

# FDMC8032L

## THERMAL CHARACTERISTICS

Rating	Symbol	Value	Unit
$R_{\theta JC}$	Thermal Resistance, Junction to Case	9.7	°C/W
$R_{\theta JA}$	Thermal Resistance, Junction to Ambient (Note 1a)	65	

## PACKAGE MARKING AND ORDERING INFORMATION

Device Marking	Device	Package	Reel Size	Tape Width	Quantity
FDMC8032L	FDMC8032L	Power 33	13"	12 mm	3000 Units

## ELECTRICAL CHARACTERISTICS ( $T_A = 25^\circ\text{C}$ unless otherwise noted)

Parameter	Test Conditions	Symbol	Min.	Typ.	Max.	Unit
-----------	-----------------	--------	------	------	------	------

### OFF CHARACTERISTICS

BVDSS	Drain to Source Breakdown Voltage	$I_D = 250 \mu\text{A}, V_{GS} = 0 \text{ V}$	40			V
$\frac{\Delta V_{DSS}}{\Delta T_J}$	Breakdown Voltage Temperature Coefficient	$I_D = 250 \mu\text{A}$ , referenced to $25^\circ\text{C}$		23		mV/°C
IDSS	Zero Gate Voltage Drain Current	$V_{DS} = 32 \text{ V}, V_{GS} = 0 \text{ V}$			1	$\mu\text{A}$
IGSS	Gate to Source Leakage Current, Forward	$V_{GS} = \pm 20 \text{ V}, V_{DS} = 0 \text{ V}$			100	nA

### ON CHARACTERISTICS

$V_{GS(th)}$	Gate to Source Threshold Voltage	$V_{GS} = V_{DS}, I_D = 250 \mu\text{A}$	1.0	1.8	3.0	V
$\frac{\Delta V_{GS(th)}}{\Delta T_J}$	Gate to Source Threshold Voltage Temperature Coefficient	$I_D = 250 \mu\text{A}$ , referenced to $25^\circ\text{C}$		-5		mV/°C
$r_{DS(on)}$	Static Drain to Source On Resistance	$V_{GS} = 10 \text{ V}, I_D = 7 \text{ A}$		16	20	m $\Omega$
		$V_{GS} = 4.5 \text{ V}, I_D = 6 \text{ A}$		21	27	
		$V_{GS} = 10 \text{ V}, I_D = 7 \text{ A}, T_J = 125^\circ\text{C}$		23	29	
$g_{FS}$	Forward Transconductance	$V_{DD} = 5 \text{ V}, I_D = 7 \text{ A}$		27		S

### DYNAMIC CHARACTERISTICS

$C_{iss}$	Input Capacitance	$V_{DS} = 20 \text{ V}, V_{GS} = 0 \text{ V}$ $f = 1 \text{ MHz}$		513	720	pF
$C_{oss}$	Output Capacitance			137	195	
$C_{rss}$	Reverse Transfer Capacitance			9.3	15	
$R_g$	Gate Resistance	$f = 1 \text{ MHz}$	0.1	2.6	3.6	$\Omega$

### SWITCHING CHARACTERISTICS

$t_{d(on)}$	Turn-On Delay Time	$V_{DD} = 20 \text{ V}, I_D = 7 \text{ A}$ $V_{GS} = 10 \text{ V},$ $R_{GEN} = 6 \Omega$		5.5	11	ns
$t_r$	Rise Time			1.2	10	
$t_{d(off)}$	Turn-Off Delay Time			13	24	
$t_f$	Fall Time			1.3	10	
$Q_{g(TOT)}$	Total Gate Charge	$V_{GS} = 0 \text{ V to } 10 \text{ V}$		7.6	11	nC
	Total Gate Charge	$V_{GS} = 0 \text{ V to } 4.5 \text{ V}$		3.6	5.1	
$Q_{gs}$	Gate to Source Charge	$V_{DD} = 20 \text{ V}$ $I_D = 7 \text{ A}$		1.5		nC
$Q_{gd}$	Gate to Drain "Miller" Charge			1.0		nC

# FDMC8032L

## ELECTRICAL CHARACTERISTICS ( $T_A = 25^\circ\text{C}$ unless otherwise noted) (continued)

Parameter	Test Conditions	Symbol	Min.	Typ.	Max.	Unit
<b>DRAIN-SOURCE DIODE CHARACTERISTICS</b>						
$V_{SD}$	Source to Drain Diode Forward Voltage	$V_{GS} = 0\text{ V}, I_S = 7\text{ A}$ (Note 2)		0.85	1.3	V
		$V_{GS} = 0\text{ V}, I_S = 1.4\text{ A}$ (Note 2)		0.75	1.2	
$t_{rr}$	Reverse Recovery Time	$I_F = 7\text{ A}, di/dt = 100\text{ A}/\mu\text{s}$		16	29	ns
$Q_{rr}$	Reverse Recovery Charge			3.9	10	nC

Product parametric performance is indicated in the Electrical Characteristics for the listed test conditions, unless otherwise noted. Product performance may not be indicated by the Electrical Characteristics if operated under different conditions.

### NOTES:

- $R_{\theta JA}$  is determined with the device mounted on a 1 in<sup>2</sup> pad 2 oz copper pad on a 1.5 x 1.5 in. board of FR-4 material.  $R_{\theta JC}$  is guaranteed by design while  $R_{\theta CA}$  is determined by the user's board design.

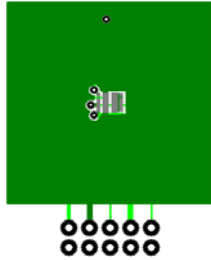

a.  $65^\circ\text{C}/\text{W}$  when mounted on a 1 in<sup>2</sup> pad of 2 oz copper



b.  $155^\circ\text{C}/\text{W}$  when mounted on a minimum pad of 2 oz copper

- Pulse Test: Pulse Width < 300  $\mu\text{s}$ , Duty cycle < 2.0%.
- $E_{AS}$  of 13 mJ is based on starting  $T_J = 25^\circ\text{C}$ ,  $L = 3\text{ mH}$ ,  $I_{AS} = 3\text{ A}$ ,  $V_{DD} = 40\text{ V}$ ,  $V_{GS} = 10\text{ V}$ . 100% tested at  $L = 0.1\text{ mH}$ ,  $I_{AS} = 11\text{ A}$ .
- Pulse Id refers to Figure.11 Forward Bias Safe Operation Area.

TYPICAL CHARACTERISTICS

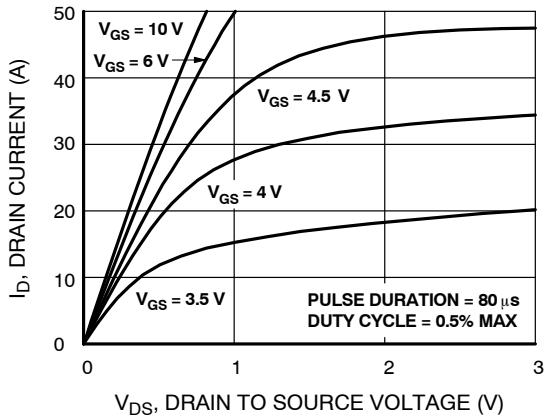

Figure 1. On-Region Characteristics

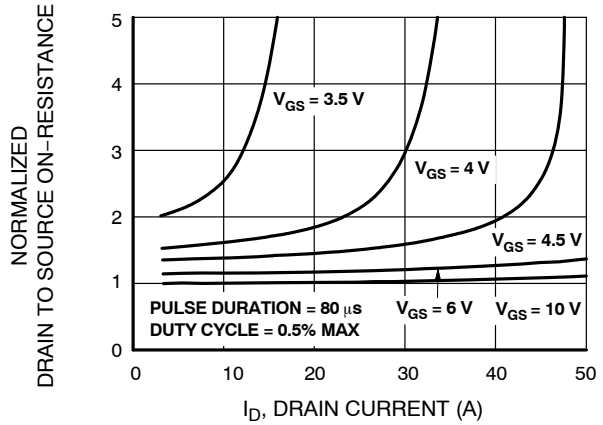

Figure 2. Normalized On-Resistance vs Drain Current and Gate Voltage

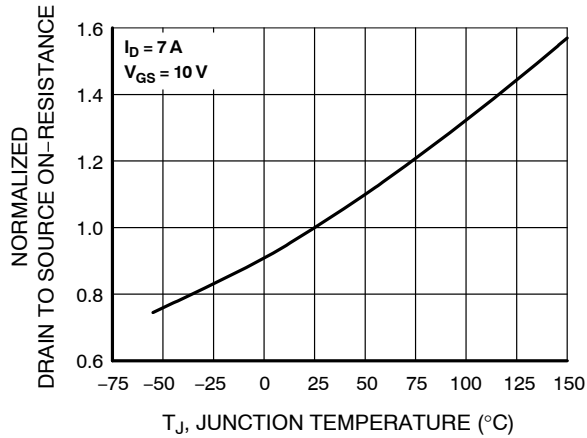

Figure 3. Normalized On-Resistance vs Junction Temperature

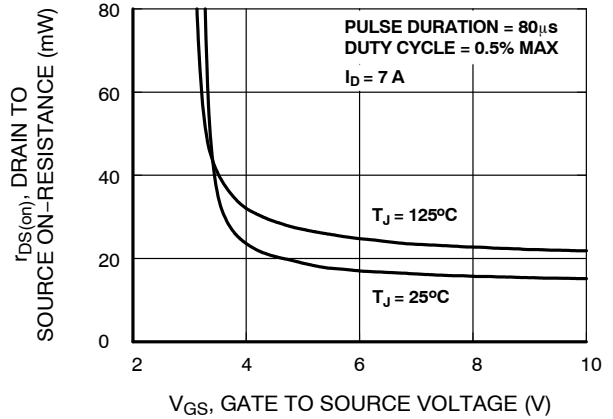

Figure 4. On-Resistance vs Gate to Source Voltage

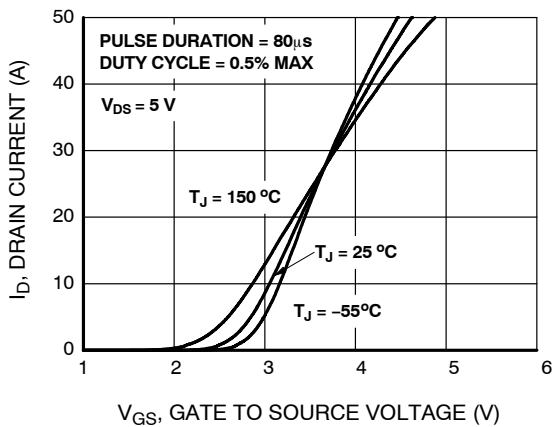

Figure 5. Transfer Characteristics

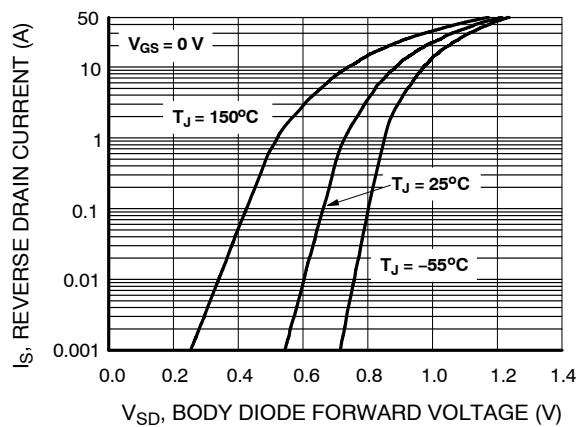

Figure 6. Source to Drain Diode Forward Voltage vs Source Current

TYPICAL CHARACTERISTICS (continued)

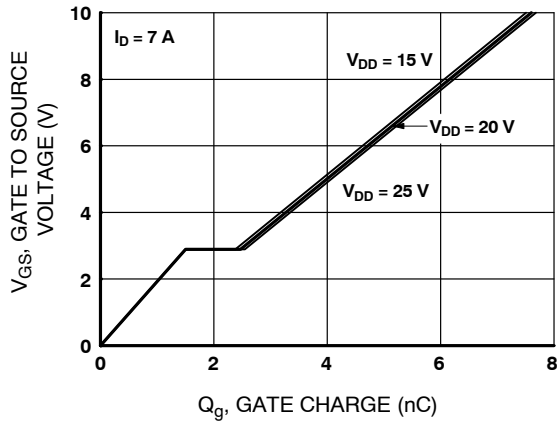

Figure 7. Gate Charge Characteristics

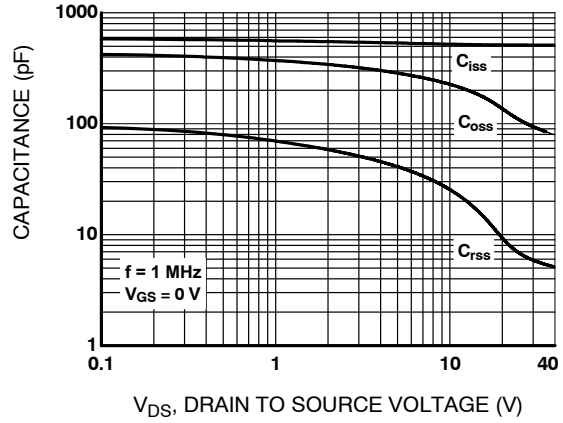

Figure 8. Capacitance vs Drain to Source Voltage

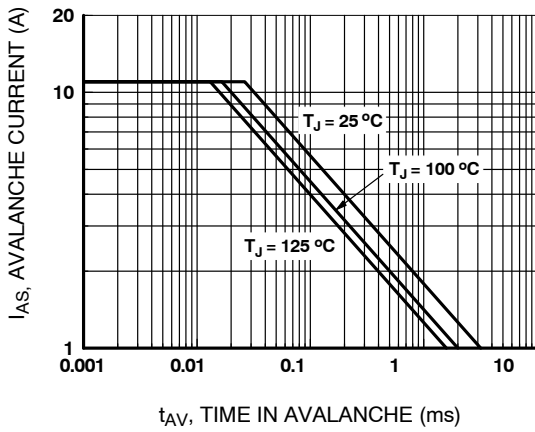

Figure 9. Unclamped Inductive Switching Capability

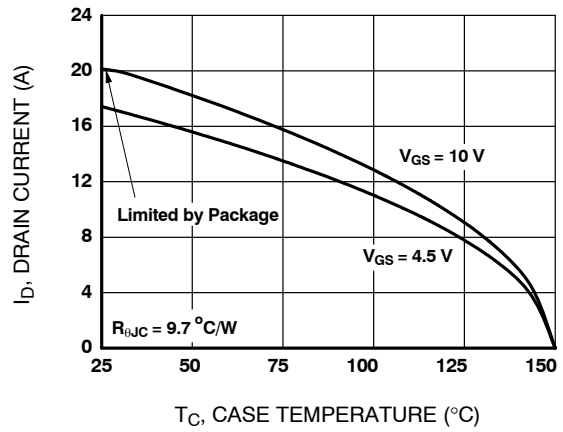

Figure 10. Maximum Continuous Drain Current vs Case Temperature

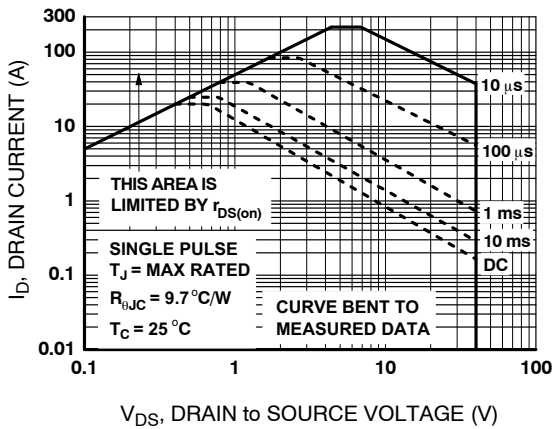

Figure 11. Forward Bias Safe Operating Area

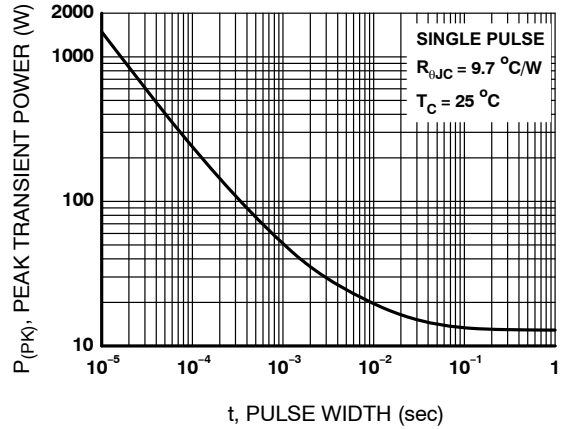

Figure 12. Single Pulse Maximum Power Dissipation

TYPICAL CHARACTERISTICS (continued)

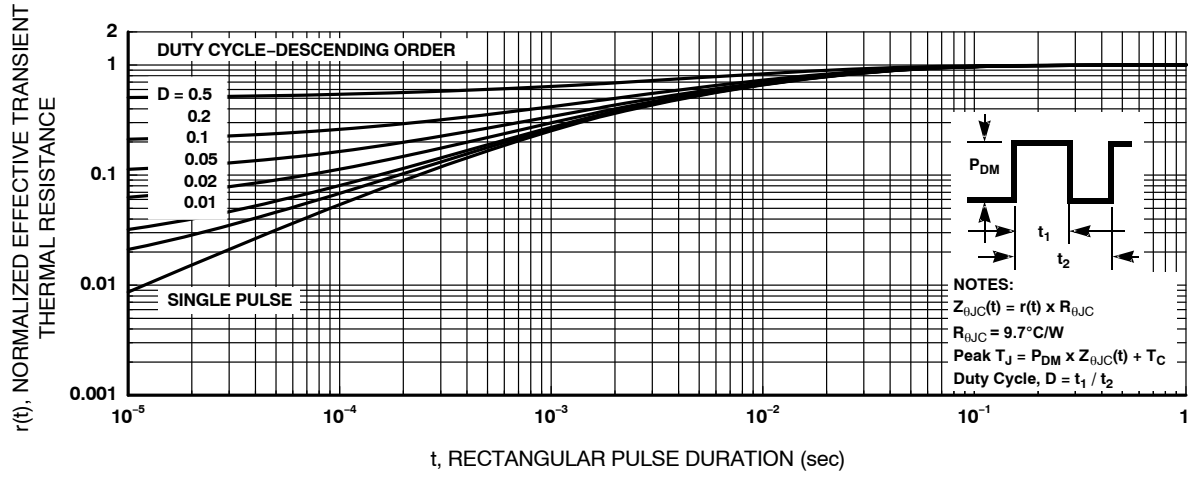
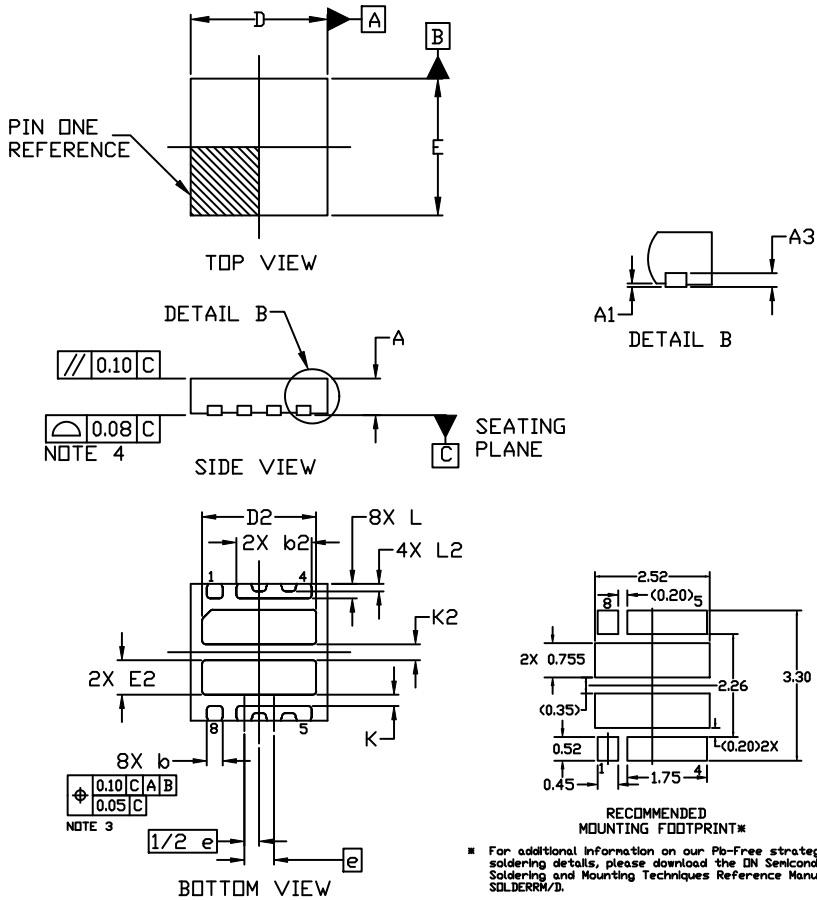

Figure 13. Transient Thermal Response Curve

**WDFN8 3x3, 0.65P**  
**CASE 511DG**  
**ISSUE A**

DATE 12 FEB 2019



NOTES:

1. DIMENSIONING AND TOLERANCING PER ASME Y14.5M, 2009.
2. CONTROLLING DIMENSION: MILLIMETERS
3. DIMENSION *b* APPLIES TO PLATED TERMINALS AND IS MEASURED BETWEEN 0.15 AND 0.30MM FROM THE TERMINAL TIP.
4. COPLANARITY APPLIES TO THE EXPOSED PAD AS WELL AS THE TERMINALS.

DIM	MILLIMETERS		
	MIN.	NOM.	MAX.
A	0.70	0.75	0.80
A1	0.00	---	0.05
A3	0.20 REF		
<i>b</i>	0.30	0.35	0.40
<i>b</i> 2	1.65 REF		
D	2.90	3.00	3.10
D2	2.45	2.50	2.55
E	2.90	3.00	3.10
E2	1.40	1.50	1.60
<i>e</i>	0.65 BSC		
K	0.25	---	---
K2	0.35 REF		
L	0.27	0.32	0.37
L2	0.163 REF		

**GENERIC MARKING DIAGRAM\***

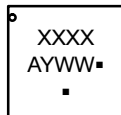

XXXX = Specific Device Code  
 A = Assembly Location  
 Y = Year  
 WW = Work Week  
 ■ = Pb-Free Package

(Note: Microdot may be in either location)

\*This information is generic. Please refer to device data sheet for actual part marking. Pb-Free indicator, "G" or microdot "■", may or may not be present. Some products may not follow the Generic Marking.

<b>DOCUMENT NUMBER:</b>	<b>98AON13623G</b>	Electronic versions are uncontrolled except when accessed directly from the Document Repository. Printed versions are uncontrolled except when stamped "CONTROLLED COPY" in red.
<b>DESCRIPTION:</b>	<b>WDFN8 3x3, 0.65P</b>	<b>PAGE 1 OF 1</b>

ON Semiconductor and are trademarks of Semiconductor Components Industries, LLC dba ON Semiconductor or its subsidiaries in the United States and/or other countries. ON Semiconductor reserves the right to make changes without further notice to any products herein. ON Semiconductor makes no warranty, representation or guarantee regarding the suitability of its products for any particular purpose, nor does ON Semiconductor assume any liability arising out of the application or use of any product or circuit, and specifically disclaims any and all liability, including without limitation special, consequential or incidental damages. ON Semiconductor does not convey any license under its patent rights nor the rights of others.

**onsemi**, **Onsemi**, and other names, marks, and brands are registered and/or common law trademarks of Semiconductor Components Industries, LLC dba "**onsemi**" or its affiliates and/or subsidiaries in the United States and/or other countries. **onsemi** owns the rights to a number of patents, trademarks, copyrights, trade secrets, and other intellectual property. A listing of **onsemi**'s product/patent coverage may be accessed at [www.onsemi.com/site/pdf/Patent-Marking.pdf](http://www.onsemi.com/site/pdf/Patent-Marking.pdf). **onsemi** reserves the right to make changes at any time to any products or information herein, without notice. The information herein is provided "as-is" and **onsemi** makes no warranty, representation or guarantee regarding the accuracy of the information, product features, availability, functionality, or suitability of its products for any particular purpose, nor does **onsemi** assume any liability arising out of the application or use of any product or circuit, and specifically disclaims any and all liability, including without limitation special, consequential or incidental damages. Buyer is responsible for its products and applications using **onsemi** products, including compliance with all laws, regulations and safety requirements or standards, regardless of any support or applications information provided by **onsemi**. "Typical" parameters which may be provided in **onsemi** data sheets and/or specifications can and do vary in different applications and actual performance may vary over time. All operating parameters, including "Typicals" must be validated for each customer application by customer's technical experts. **onsemi** does not convey any license under any of its intellectual property rights nor the rights of others. **onsemi** products are not designed, intended, or authorized for use as a critical component in life support systems or any FDA Class 3 medical devices or medical devices with a same or similar classification in a foreign jurisdiction or any devices intended for implantation in the human body. Should Buyer purchase or use **onsemi** products for any such unintended or unauthorized application, Buyer shall indemnify and hold **onsemi** and its officers, employees, subsidiaries, affiliates, and distributors harmless against all claims, costs, damages, and expenses, and reasonable attorney fees arising out of, directly or indirectly, any claim of personal injury or death associated with such unintended or unauthorized use, even if such claim alleges that **onsemi** was negligent regarding the design or manufacture of the part. **onsemi** is an Equal Opportunity/Affirmative Action Employer. This literature is subject to all applicable copyright laws and is not for resale in any manner.

## PUBLICATION ORDERING INFORMATION

### LITERATURE FULFILLMENT:

Email Requests to: [orderlit@onsemi.com](mailto:orderlit@onsemi.com)

**onsemi Website:** [www.onsemi.com](http://www.onsemi.com)

### TECHNICAL SUPPORT

**North American Technical Support:**  
Voice Mail: 1 800-282-9855 Toll Free USA/Canada  
Phone: 011 421 33 790 2910

**Europe, Middle East and Africa Technical Support:**

Phone: 00421 33 790 2910

For additional information, please contact your local Sales Representative