

MOSFET – Single, P-Channel, POWERTRENCH®

-30 V, -11 A, 13.5 mΩ

FDMA6676PZ

Description

This device is an ultra low resistance P-Channel FET. It is designed for power line load switching applications and reverse polarity protection. It is especially optimized for voltage rails that can climb as high as 25 V. Typical end systems include laptop computers, tablets and mobile phone. Applications include battery protection, input power line protection and charge path protection, including USB and other charge paths. The FDMA6676PZ has an enhanced V_{GS} rating of 25 V specifically designed to simplify installation. When used as reverse polarity protection, with gate tied to ground and drain tied to V input, it is designed to support operating input voltages that can raise as high as 25 V without the need for external Zener protection on the gate. Its small 2 x 2 x 0.8 mm form factor make it an ideal part for mobile and space constrained applications.

Features

- Max $r_{DS(on)}$ = 13.5 mΩ @ $V_{GS} = -10$ V
- 25 V V_{GS} Extended Operating Rating
- 30 V V_{DS} Blocking
- 2 x 2 mm Form Factor
- Low Profile – 0.8 mm Maximum
- Integrated Protection Diode
- These Devices are Pb-Free, Halogen Free/BFR Free and are RoHS Compliant



ON Semiconductor®

www.onsemi.com

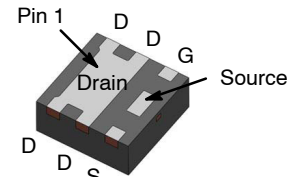

**WDFN6
CASE 483AV**

MARKING DIAGRAM

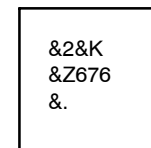

&2	= 2-Digit Date Code
&K	= Lot Code
&Z	= Assembly Plant Code
676	= Specific Device Code
&	= Pin 1 Dot

PIN CONNECTION

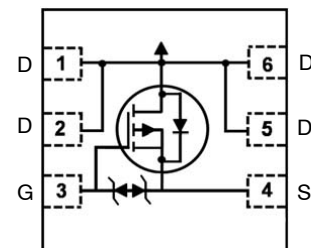

ORDERING INFORMATION

See detailed ordering and shipping information on page 3 of this data sheet.

FDMA6676PZ

ABSOLUTE MAXIMUM RATINGS

Symbol	Parameter	Ratings	Unit
V_{DS}	Drain to Source Voltage	-30	V
V_{GS}	Gate to Source Voltage	± 25	V
I_D	Drain Current – Continuous, $T_A = 25^\circ\text{C}$ (Note 1a)	-11	A
	– Pulsed (Note 3)	-165	
P_D	Power Dissipation $T_A = 25^\circ\text{C}$ (Note 1a)	2.4	W
	Power Dissipation $T_A = 25^\circ\text{C}$ (Note 1b)	0.9	
T_J, T_{STG}	Operating and Storage Junction Temperature Range	-55 to +150	$^\circ\text{C}$

Stresses exceeding those listed in the Maximum Ratings table may damage the device. If any of these limits are exceeded, device functionality should not be assumed, damage may occur and reliability may be affected.

THERMAL CHARACTERISTICS

Symbol	Characteristic	Value	Unit
$R_{\theta JA}$	Thermal Resistance, Junction to Ambient (Note 1a)	52	$^\circ\text{C}/\text{W}$
$R_{\theta JA}$	Thermal Resistance, Junction to Ambient (Note 1b)	145	

ELECTRICAL CHARACTERISTICS ($T_J = 25^\circ\text{C}$ unless otherwise noted)

Symbol	Parameter	Test Condition	Min.	Typ.	Max.	Unit
--------	-----------	----------------	------	------	------	------

OFF CHARACTERISTICS

BV_{DSS}	Drain to Source Breakdown Voltage	$I_D = -250 \mu\text{A}, V_{GS} = 0 \text{ V}$	-30			V
$\Delta BV_{DSS} / \Delta T_J$	Breakdown Voltage Temperature Coefficient	$I_D = -250 \mu\text{A}$, Referenced to 25°C		-19		$\text{mV}/^\circ\text{C}$
I_{DSS}	Zero Gate Voltage Drain Current	$V_{DS} = -24 \text{ V}, V_{GS} = 0 \text{ V}$			-1	μA
I_{GSS}	Gate to Source Leakage Current	$V_{GS} = \pm 25 \text{ V}, V_{DS} = 0 \text{ V}$			± 10	μA

ON CHARACTERISTICS

$V_{GS(th)}$	Gate to Source Threshold Voltage	$V_{GS} = V_{DS}, I_D = -250 \mu\text{A}$	-1.2	-2	-2.6	V
$\Delta V_{GS(th)} / \Delta T_J$	Gate to Source Threshold Voltage Temperature Coefficient	$I_D = -250 \mu\text{A}$, Referenced to 25°C		5.9		$\text{mV}/^\circ\text{C}$
$r_{DS(on)}$	Static Drain to Source On Resistance	$V_{GS} = -10 \text{ V}, I_D = -11 \text{ A}$		11	13.5	$\text{m}\Omega$
		$V_{GS} = -4.5 \text{ V}, I_D = -8 \text{ A}$		19	27	
		$V_{GS} = -10 \text{ V}, I_D = -11 \text{ A}, T_J = 125^\circ\text{C}$		14.5	21	
g_{FS}	Forward Transconductance	$V_{DD} = -5 \text{ V}, I_D = -11 \text{ A}$		38		S

DYNAMIC CHARACTERISTICS

C_{iss}	Input Capacitance	$V_{DS} = -15 \text{ V}, V_{GS} = 0 \text{ V}, f = 1 \text{ MHz}$		1440	2160	pF
C_{oss}	Output Capacitance			477	720	pF
C_{rss}	Reverse Transfer Capacitance			458	690	pF
R_g	Gate Resistance			12		Ω

SWITCHING CHARACTERISTICS

$t_{d(on)}$	Turn-On Delay Time	$V_{DD} = -15 \text{ V}, I_D = -11 \text{ A},$ $V_{GS} = -10 \text{ V}, R_{GEN} = 6 \Omega$		8.8	18	ns
t_r	Rise Time			19	34	ns
$t_{d(off)}$	Turn-Off Delay Time			87	139	ns
t_f	Fall Time			72	115	ns
Q_g	Total Gate Charge	$V_{GS} = 0 \text{ V to } -10 \text{ V},$ $V_{DD} = -15 \text{ V}, I_D = -11 \text{ A}$		33	46	nC

FDMA6676PZ

ELECTRICAL CHARACTERISTICS ($T_J = 25^\circ\text{C}$ unless otherwise noted) (continued)

Symbol	Parameter	Test Condition	Min.	Typ.	Max.	Unit
--------	-----------	----------------	------	------	------	------

SWITCHING CHARACTERISTICS

Q_g	Total Gate Charge	$V_{GS} = 0\text{ V to } -4.5\text{ V}$, $V_{DD} = -15\text{ V}$, $I_D = -11\text{ A}$		20	28	nC
Q_{gs}	Gate to Source Charge	$V_{DD} = -15\text{ V}$, $I_D = -11\text{ A}$		4.5		nC
Q_{gd}	Gate to Drain "Miller" Charge	$V_{DD} = -15\text{ V}$, $I_D = -11\text{ A}$		13		nC

DRAIN-SOURCE DIODE CHARACTERISTICS

V_{SD}	Source to Drain Diode Forward Voltage	$V_{GS} = 0\text{ V}$, $I_S = -2\text{ A}$ (Note 2)		-0.7	-1.2	V
		$V_{GS} = 0\text{ V}$, $I_S = -11\text{ A}$ (Note 2)		-0.9	-1.4	V
t_{rr}	Reverse Recovery Time	$I_F = -11\text{ A}$, $di/dt = 100\text{ A}/\mu\text{s}$		31	50	ns
Q_{rr}	Reverse Recovery Charge			9	18	nC

Product parametric performance is indicated in the Electrical Characteristics for the listed test conditions, unless otherwise noted. Product performance may not be indicated by the Electrical Characteristics if operated under different conditions.

- $R_{\theta JA}$ is determined with the device mounted on a 1 in² pad 2 oz copper pad on a 1.5 x 1.5 in. board of FR-4 material. $R_{\theta CA}$ is determined by the user's board design.

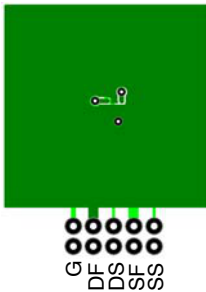

a. $52^\circ\text{C}/\text{W}$ when mounted on a 1 in² pad of 2 oz copper.



b. $145^\circ\text{C}/\text{W}$ when mounted on a minimum pad of 2 oz copper.

- Pulse Test: Pulse Width < 300 μs , Duty cycle < 2.0%.
- Pulse I_D refers to Forward Bias Safe Operation Area.

ORDERING INFORMATION

Device Marking	Device	Package	Package Method [†]
676	FDMA6676PZ	WDFN-6	3000 Tape / Reel

[†]For information on tape and reel specifications, including part orientation and tape sizes, please refer to our Tape and Reel Packaging Specifications Brochure, BRD8011/D.

TYPICAL CHARACTERISTICS ($T_J = 25^\circ\text{C}$ unless otherwise noted)

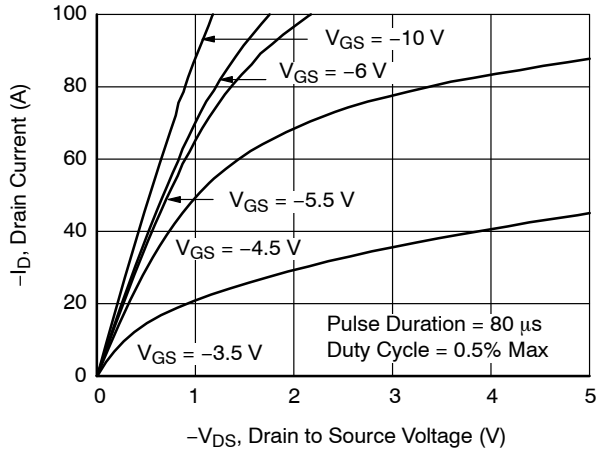

Figure 1. On-Region Characteristics

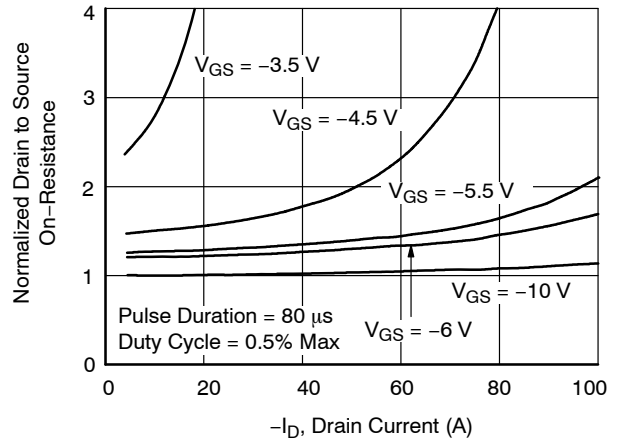

Figure 2. Normalized On-Resistance vs. Drain Current and Gate Voltage

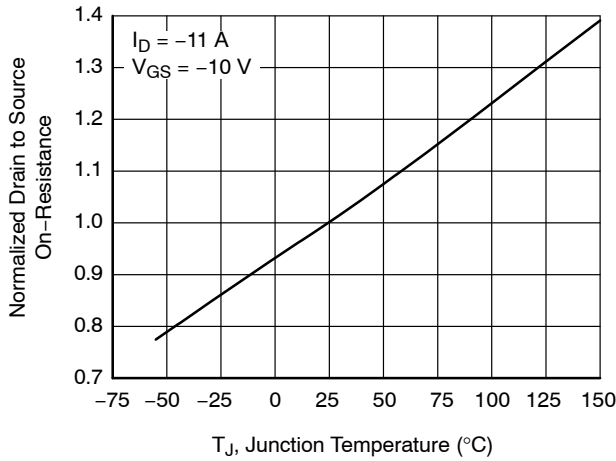

Figure 3. Normalized On-Resistance vs. Junction Temperature

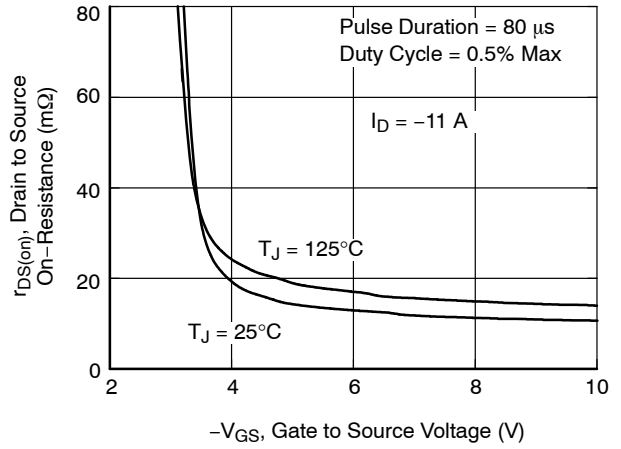

Figure 4. On-Resistance vs. Gate to Source Voltage

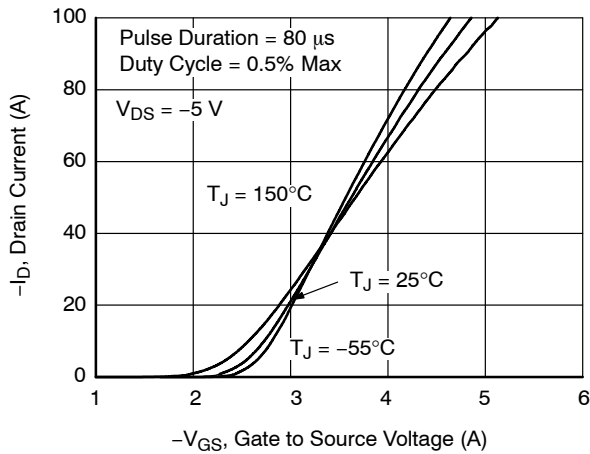

Figure 5. Transfer Characteristics

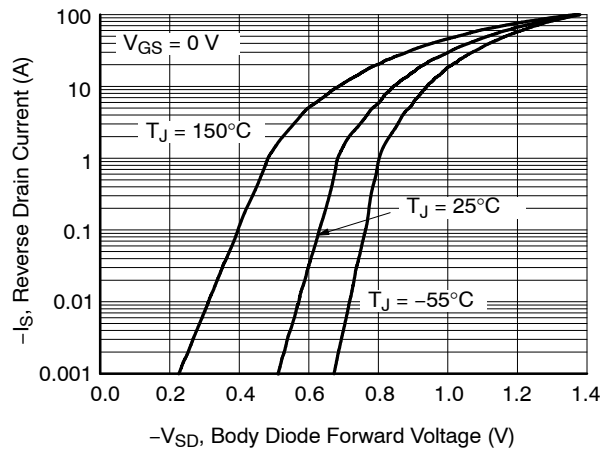

Figure 6. Source to Drain Diode Forward Voltage vs. Source Current

TYPICAL CHARACTERISTICS ($T_J = 25^\circ\text{C}$ unless otherwise noted)

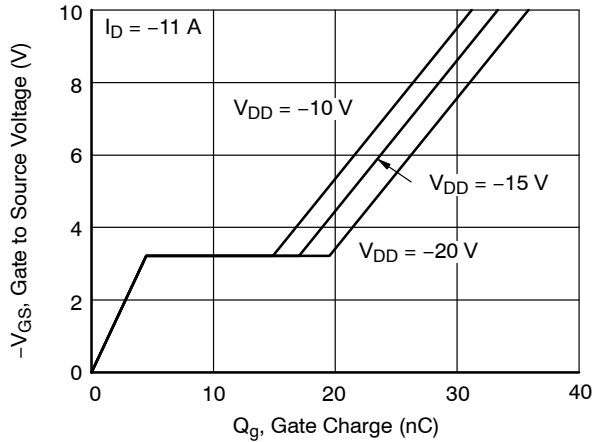

Figure 7. Gate Charge Characteristics

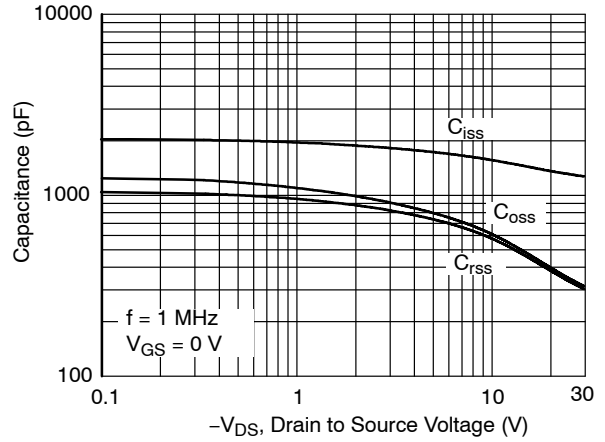

Figure 8. Capacitance vs. Drain to Source Voltage

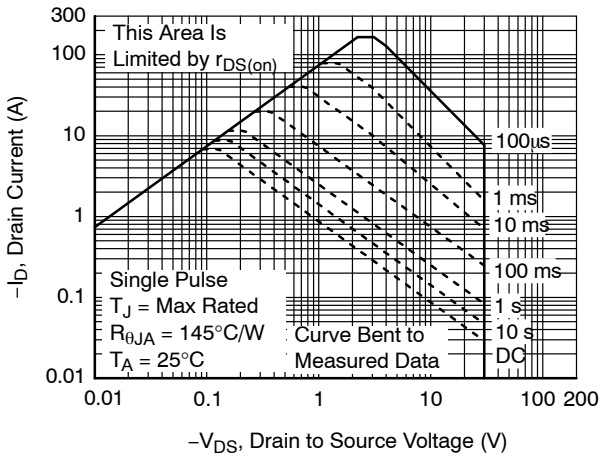

Figure 9. Forward Bias Safe Operating Area

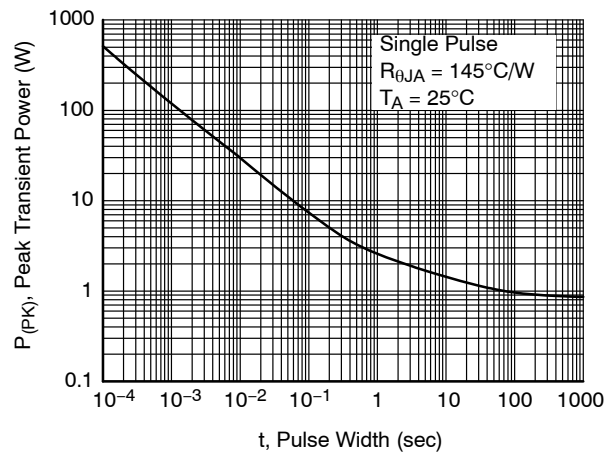

Figure 10. Single Pulse Maximum Power Dissipation

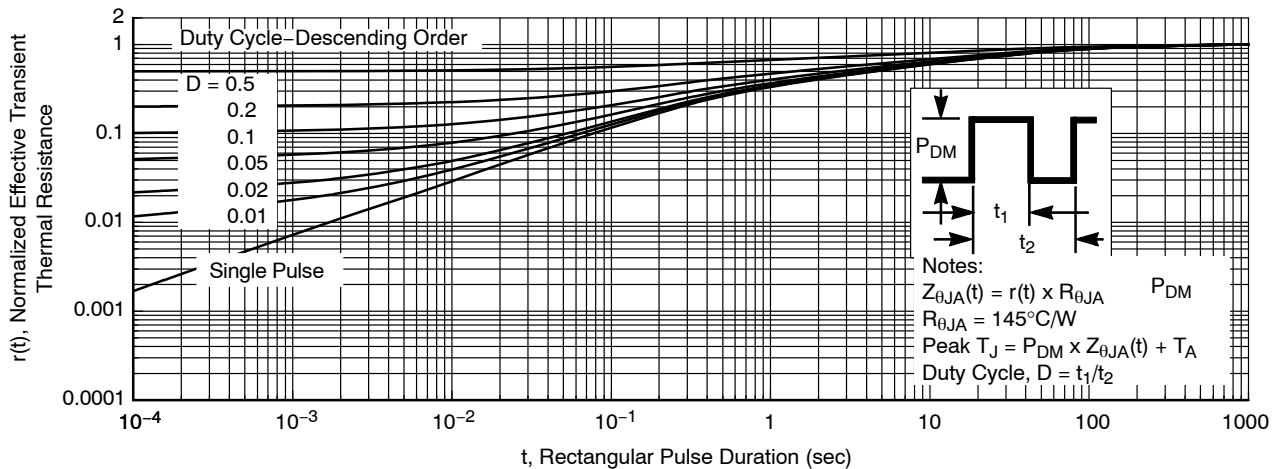
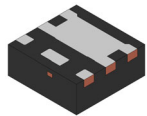

Figure 11. Junction-to-Ambient Transient Thermal Response Curve

POWERTRENCH is registered trademark of Semiconductor Components Industries, LLC (SCILLC) or its subsidiaries in the United States and/or other countries.



WDFN6 2.05X2.05, 0.65P
CASE 483AV
ISSUE A

DATE 02 APR 2019

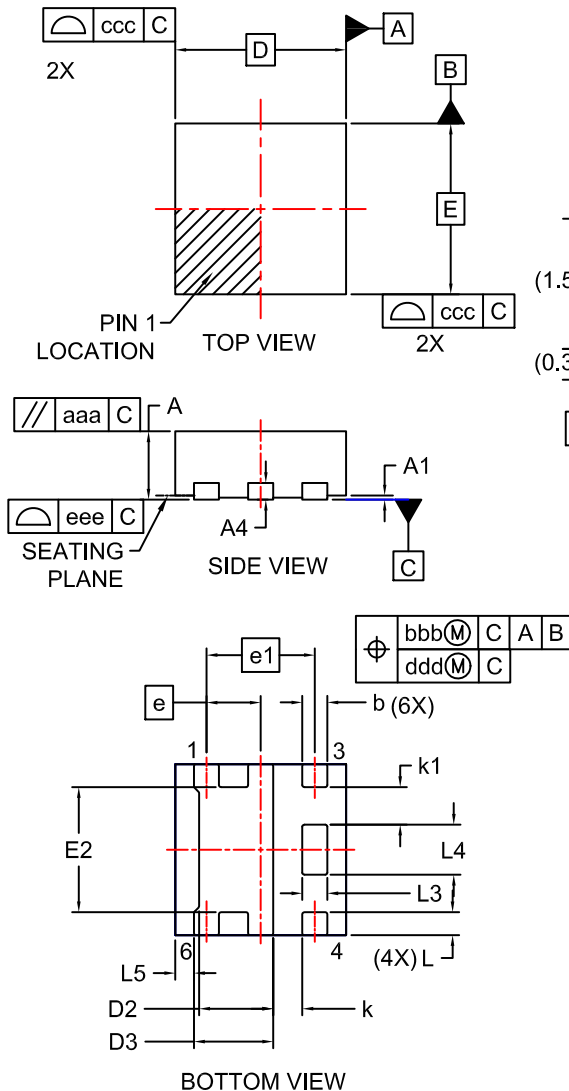

LAND PATTERN RECOMMENDATION

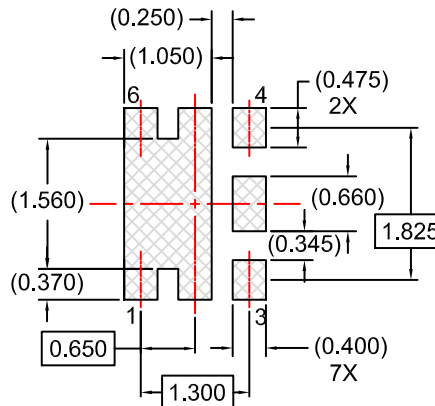

NOTES:

1. CONTROLLING DIMENSION: MILLIMETERS.
2. COPLANARITY APPLIES TO THE EXPOSED PADS AS WELL AS THE TERMINALS.
3. DIMENSIONS D AND E DO NOT INCLUDE MOLD FLASH, PROTRUSIONS OR GATE BURRS.
4. SEATING PLANE IS DEFINED BY THE TERMINALS. "A1" IS DEFINED AS THE DISTANCE FROM THE SEATING PLANE TO THE LOWEST POINT ON THE PACKAGE BODY.

DIM	MILLIMETERS		
	MIN.	NOM.	MAX.
A	0.60	0.70	0.80
A1	0.00	-	0.05
A4	(0.20)		
b	0.25	0.30	0.35
D	1.95	2.05	2.15
D2	0.84	0.89	0.94
D3	(0.95)		
E	1.95	2.05	2.15
E2	1.45	1.50	1.55
e	0.65 BSC		
e1	1.30 BSC		
k	(0.35)		
k1	(0.45)		
L	0.18	0.28	0.38
L3	0.25	0.30	0.35
L4	0.55	0.60	0.65
L5	(0.23)		
aaa	0.10		
bbb	0.10		
ccc	0.05		
ddd	0.05		
eee	0.05		

DOCUMENT NUMBER:	98AON13671G	Electronic versions are uncontrolled except when accessed directly from the Document Repository. Printed versions are uncontrolled except when stamped "CONTROLLED COPY" in red.
DESCRIPTION:	WDFN6 2.05X2.05, 0.65P	PAGE 1 OF 1

onsemi and Onsemi are trademarks of Semiconductor Components Industries, LLC dba onsemi or its subsidiaries in the United States and/or other countries. onsemi reserves the right to make changes without further notice to any products herein. onsemi makes no warranty, representation or guarantee regarding the suitability of its products for any particular purpose, nor does onsemi assume any liability arising out of the application or use of any product or circuit, and specifically disclaims any and all liability, including without limitation special, consequential or incidental damages. onsemi does not convey any license under its patent rights nor the rights of others.

onsemi, **Onsemi**, and other names, marks, and brands are registered and/or common law trademarks of Semiconductor Components Industries, LLC dba "**onsemi**" or its affiliates and/or subsidiaries in the United States and/or other countries. **onsemi** owns the rights to a number of patents, trademarks, copyrights, trade secrets, and other intellectual property. A listing of **onsemi**'s product/patent coverage may be accessed at www.onsemi.com/site/pdf/Patent-Marking.pdf. **onsemi** reserves the right to make changes at any time to any products or information herein, without notice. The information herein is provided "as-is" and **onsemi** makes no warranty, representation or guarantee regarding the accuracy of the information, product features, availability, functionality, or suitability of its products for any particular purpose, nor does **onsemi** assume any liability arising out of the application or use of any product or circuit, and specifically disclaims any and all liability, including without limitation special, consequential or incidental damages. Buyer is responsible for its products and applications using **onsemi** products, including compliance with all laws, regulations and safety requirements or standards, regardless of any support or applications information provided by **onsemi**. "Typical" parameters which may be provided in **onsemi** data sheets and/or specifications can and do vary in different applications and actual performance may vary over time. All operating parameters, including "Typicals" must be validated for each customer application by customer's technical experts. **onsemi** does not convey any license under any of its intellectual property rights nor the rights of others. **onsemi** products are not designed, intended, or authorized for use as a critical component in life support systems or any FDA Class 3 medical devices or medical devices with a same or similar classification in a foreign jurisdiction or any devices intended for implantation in the human body. Should Buyer purchase or use **onsemi** products for any such unintended or unauthorized application, Buyer shall indemnify and hold **onsemi** and its officers, employees, subsidiaries, affiliates, and distributors harmless against all claims, costs, damages, and expenses, and reasonable attorney fees arising out of, directly or indirectly, any claim of personal injury or death associated with such unintended or unauthorized use, even if such claim alleges that **onsemi** was negligent regarding the design or manufacture of the part. **onsemi** is an Equal Opportunity/Affirmative Action Employer. This literature is subject to all applicable copyright laws and is not for resale in any manner.

ADDITIONAL INFORMATION

TECHNICAL PUBLICATIONS:

Technical Library: www.onsemi.com/design/resources/technical-documentation
onsemi Website: www.onsemi.com

ONLINE SUPPORT: www.onsemi.com/support

For additional information, please contact your local Sales Representative at www.onsemi.com/support/sales