

Digital FET, Dual N-Channel

FDC6303N

General Description

These dual N-Channel logic level enhancement mode field effect transistors are produced using onsemi's proprietary, high cell density, DMOS technology. This very high density process is especially tailored to minimize on-state resistance. This device has been designed especially for low voltage applications as a replacement for digital transistors in load switching applications. Since bias resistors are not required this one N-Channel FET can replace several digital transistors with different bias resistors like the IMHxA series.

Features

- 25 V, 0.68 A Continuous, 2 A Peak
 - ♦ $R_{DS(on)} = 0.6 \Omega @ V_{GS} = 2.7 V$
 - ♦ $R_{DS(on)} = 0.45 \Omega @ V_{GS} = 4.5 V$
- Very Low Level Gate Drive Requirements Allowing Direct Operation in 3 V Circuits, $V_{GS(th)} < 1.5 V$
- Gate-Source Zener for ESD Ruggedness, >6 kV Human Body Model
- Replace Multiple NPN Digital Transistors (IMHxA Series) with One DMOS FET
- This Device is Pb-Free, Halide Free and is RoHS Compliant

ABSOLUTE MAXIMUM RATINGS (T_A = 25°C, unless otherwise noted)

Symbol	Parameter	FDC6303N	Unit
V _{DSS}	Drain-Source Voltage	25	V
V _{GSS}	Gate-Source Voltage	8	V
I _D	Drain Current - Continuous - Pulsed	0.68 2	A
P _D	Maximum Power Dissipation (Note 1a) (Note 1b)	0.9 0.7	W
T _J , T _{STG}	Operating and Storage Temperature Range	-55 to 150	°C
ESD	Electrostatic Discharge Rating MIL-STD-883D Human Body Model (100 pf / 1500 Ohm)	6.0	kV

Stresses exceeding those listed in the Maximum Ratings table may damage the device. If any of these limits are exceeded, device functionality should not be assumed, damage may occur and reliability may be affected.

THERMAL CHARACTERISTICS (T_A = 25°C, unless otherwise noted)

Symbol	Parameter	FDC6303N	Unit
R _{θJA}	Thermal Resistance, Junction-to-Ambient (Note 1a)	140	°C/W
R _{θJC}	Thermal Resistance, Junction-to-Case (Note 1)	60	°C/W

V _{DSS}	R _{DS(on)} MAX	I _D MAX
25 V	0.45 mΩ @ 4.5 V	0.68 A
	0.6 mΩ @ 2.7 V	

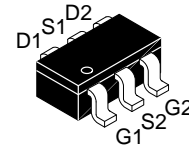

TSOT23 6-Lead
SUPERSOT™-6
CASE 419BL

MARKING DIAGRAM

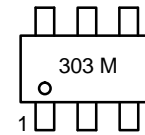

303 = Specific Device Code
M = Date Code

PIN CONNECTIONS

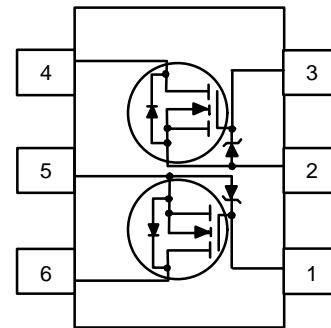

ORDERING INFORMATION

Device	Package	Shipping†
FDC6303N	TSOT23 6-Lead, SUPERSOT-6 (Pb-Free, Halide Free)	3000 / Tape & Reel

†For information on tape and reel specifications, including part orientation and tape sizes, please refer to our Tape and Reel Packaging Specifications Brochure, [BRD8011/D](#).

FDC6303N

DMOS ELECTRICAL CHARACTERISTICS (T_A = 25°C unless otherwise noted)

Symbol	Parameter	Test Condition	Min	Typ	Max	Unit
--------	-----------	----------------	-----	-----	-----	------

OFF CHARACTERISTICS

BV _{DSS}	Drain–Source Breakdown Voltage	V _{GS} = 0 V, I _D = 250 μA	25	–	–	V
ΔBV _{DSS} / ΔT _J	Breakdown Voltage Temp. Coefficient	I _D = 250 μA, Referenced to 25°C	–	26	–	mV / °C
I _{DSS}	Zero Gate Voltage Drain Current	V _{DS} = 20 V, V _{GS} = 0 V	–	–	1	μA
		V _{DS} = 20 V, V _{GS} = 0 V, T _J = 55°C	–	–	10	μA
I _{GSS}	Gate – Body Leakage Current	V _{GS} = 8 V, V _{DS} = 0 V	–	–	100	nA

ON CHARACTERISTICS (Note 2)

ΔV _{GS(th)} / ΔT _J	Gate Threshold Voltage Temp. Coefficient	I _D = 250 μA, Referenced to 25°C	–	–2.6	–	mV / °C
V _{GS(th)}	Gate Threshold Voltage	V _{DS} = V _{GS} , I _D = 250 μA	0.65	0.8	1.5	V
R _{DS(on)}	Static Drain–Source On–Resistance	V _{GS} = 4.5 V, I _D = 0.5 A	–	0.33	0.45	Ω
		V _{GS} = 4.5 V, I _D = 0.5 A, T _J = 125°C	–	0.52	0.8	
		V _{GS} = 2.7 V, I _D = 0.2 A	–	0.44	0.6	
I _{D(ON)}	On–State Drain Current	V _{GS} = 2.7 V, V _{DS} = 5 V	0.5	–	–	A
g _{FS}	Forward Transconductance	V _{DS} = 5 V, I _D = 0.5 A	–	1.45	–	S

DYNAMIC CHARACTERISTICS

C _{iss}	Input Capacitance	V _{DS} = 10 V, V _{GS} = 0 V, f = 1.0 MHz	–	50	–	pF
C _{oss}	Output Capacitance		–	28	–	pF
C _{rss}	Reverse Transfer Capacitance		–	9	–	pF

SWITCHING CHARACTERISTICS (Note 2)

t _{D(on)}	Turn – On Delay Time	V _{DD} = 6 V, I _D = 0.5 A, V _{GS} = 4.5 V, R _{GEN} = 50 Ω	–	3	6	ns
t _r	Turn – On Rise Time		–	8.5	18	ns
t _{D(off)}	Turn – Off Delay Time		–	17	30	ns
t _f	Turn – Off Fall Time		–	13	25	ns
Q _g	Total Gate Charge	V _{DS} = 5 V, I _D = 0.5 A, V _{GS} = 4.5 V	–	1.64	2.3	nC
Q _{gs}	Gate–Source Charge		–	0.38	–	nC
Q _{gd}	Gate–Drain Charge		–	0.45	–	nC

DRAIN–SOURCE DIODE CHARACTERISTICS AND MAXIMUM RATINGS

I _S	Maximum Continuous Source Current	–	–	0.3	A	
V _{SD}	Drain–Source Diode Forward Voltage	V _{GS} = 0 V, I _S = 0.5 A (Note 2)	–	0.83	1.2	V

Product parametric performance is indicated in the Electrical Characteristics for the listed test conditions, unless otherwise noted. Product performance may not be indicated by the Electrical Characteristics if operated under different conditions.

- R_{θJA} is the sum of the junction–to–case and case–to–ambient thermal resistance where the case thermal reference is defined as the solder mounting surface of the drain pins. R_{θJC} is guaranteed by design while R_{θCA} is determined by the user's board design. R_{θJA} shown below for single device operation on FR–4 in still air.

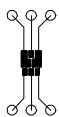

- 140°C/W on a 0.125 in² pad of 2 oz copper.

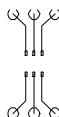

- 180°C/W on a 0.005 in² of pad of 2oz copper.

- Pulse Test: Pulse Width ≤ 300 μs, Duty Cycle ≤ 2.0%.

TYPICAL ELECTRICAL CHARACTERISTICS

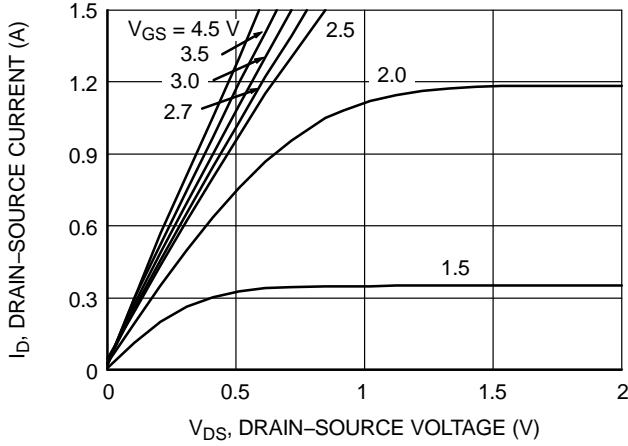

Figure 1. On-Region Characteristics

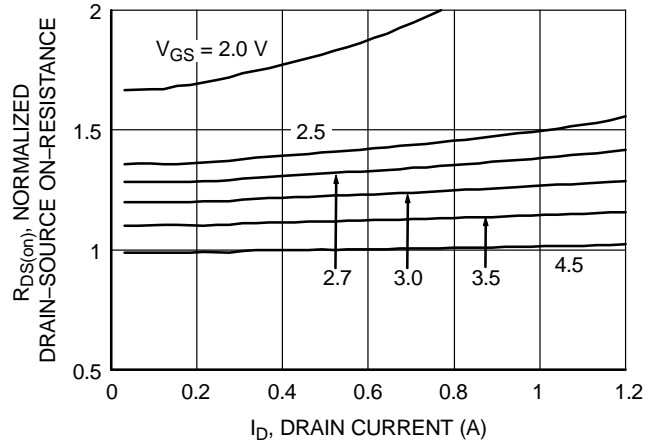

Figure 2. On-Resistance Variation with Drain Current and Gate Voltage

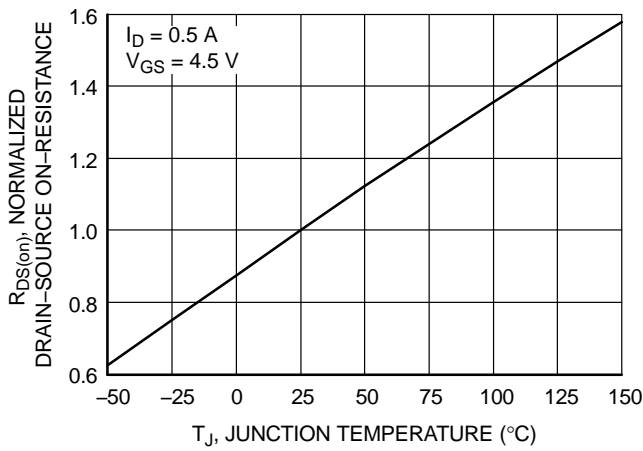

Figure 3. On-Resistance Variation with Temperature

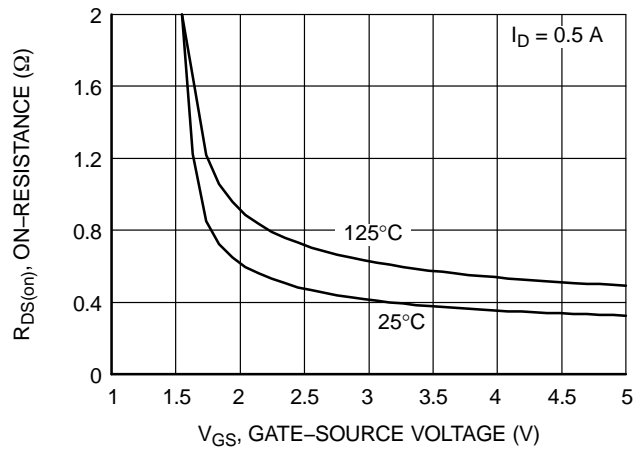

Figure 4. On Resistance Variation with Gate-To-Source Voltage

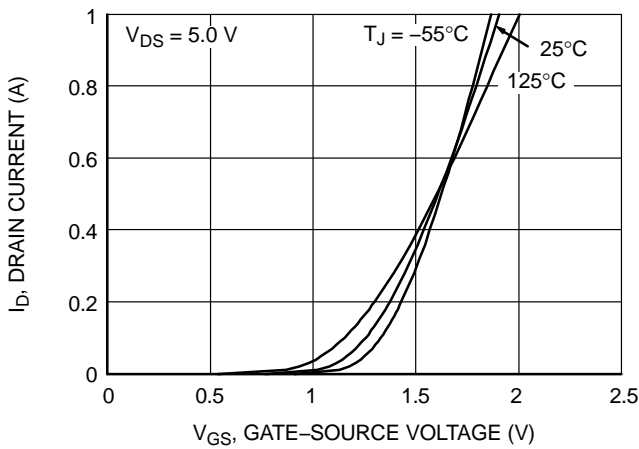

Figure 5. Transfer Characteristics

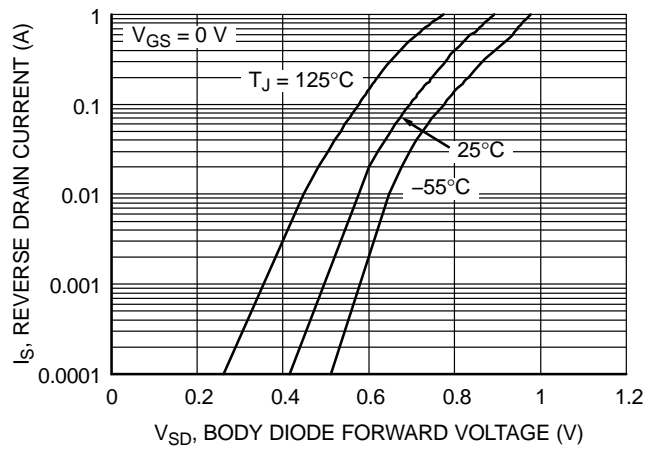

Figure 6. Body Diode Forward Voltage Variation with Source Current and Temperature

TYPICAL ELECTRICAL AND THERMAL CHARACTERISTICS

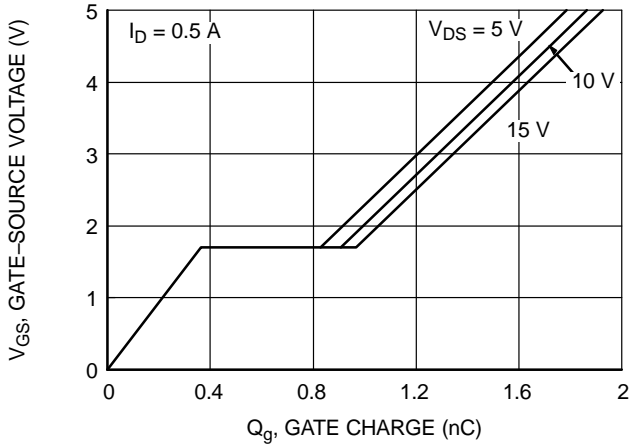

Figure 7. Gate Charge Characteristics

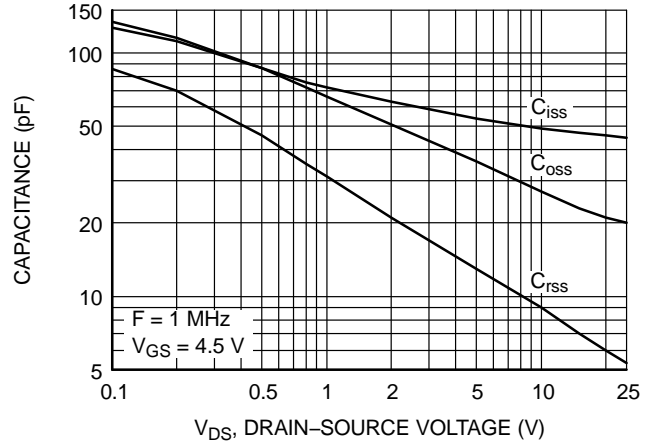

Figure 8. Capacitance Characteristics

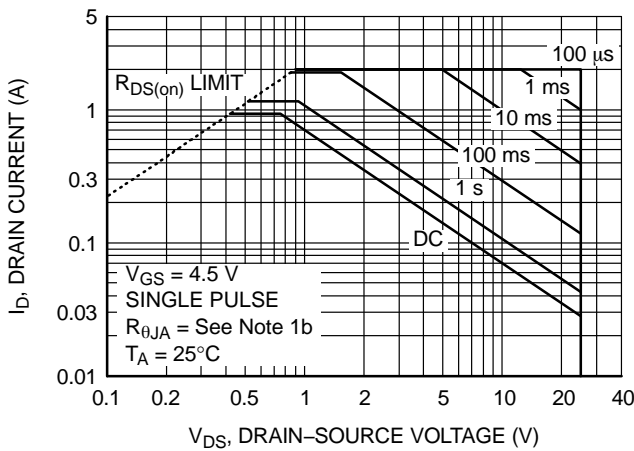

Figure 9. Maximum Safe Operating Area

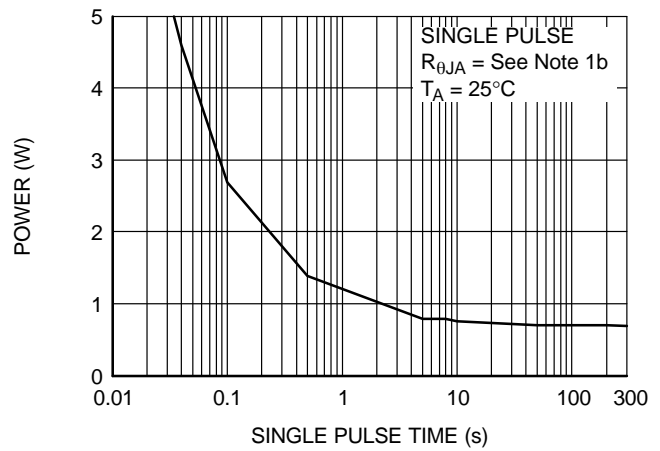

Figure 10. Single Pulse Maximum Power Dissipation

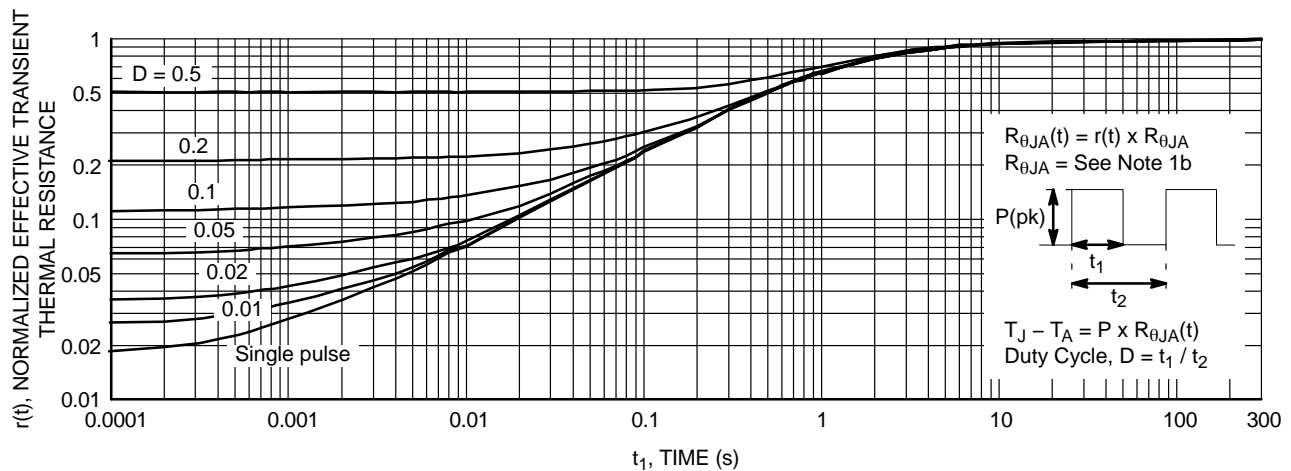

Figure 11. Transient Thermal Response Curve.

(Note: Thermal characterization performed using the conditions described in Note 1b. Transient thermal response will change depending on the circuit board design.)



1
SCALE 2:1

TSOT23 6-Lead
CASE 419BL
ISSUE A

DATE 31 AUG 2020

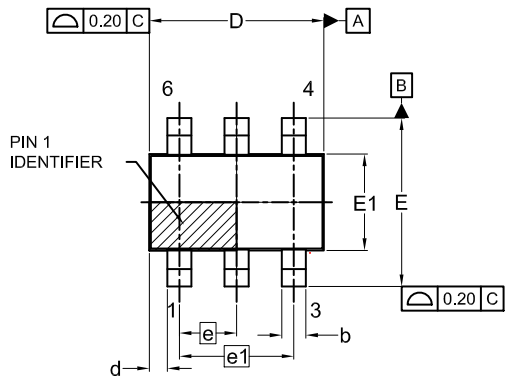

TOP VIEW

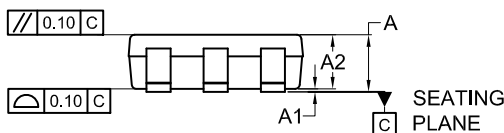

FRONT VIEW

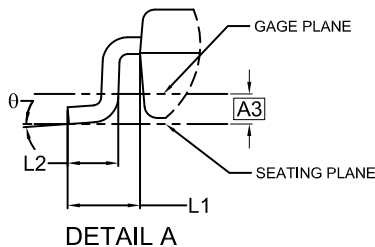

DETAIL A

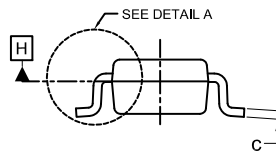

SIDE VIEW

SYMM
⌀

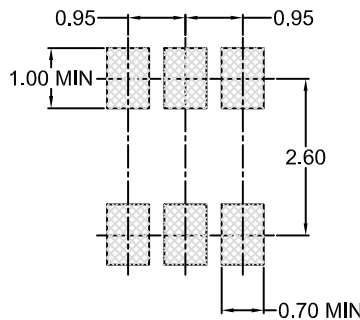

LAND PATTERN
RECOMMENDATION

*FOR ADDITIONAL INFORMATION ON OUR
Pb-FREE STRATEGY AND SOLDERING DETAILS,
PLEASE DOWNLOAD THE ON SEMICONDUCTOR
SOLDERING AND MOUNTING TECHNIQUES
REFERENCE MANUAL, SOLDERRM/D.

NOTES:

1. DIMENSIONING AND TOLERANCING PER ASME Y14.5M, 2009.
2. CONTROLLING DIMENSION: MILLIMETERS
3. DIMENSIONS D AND E1 DO NOT INCLUDE MOLD FLASH, PROTRUSIONS, OR GATE BURRS. MOLD FLASH, PROTRUSIONS OR GATE BURRS SHALL NOT EXCEED 0.25MM PER END. DIMENSIONS D AND E1 ARE DETERMINED AT DATUM H.
4. SEATING PLANE IS DEFINED BY THE TERMINALS. "A1" IS DEFINED AS THE DISTANCE FROM THE SEATING PLANE TO THE LOWEST POINT ON THE PACKAGE BODY.

DIM	MILLIMETERS		
	MIN.	NOM.	MAX.
A	0.90	1.00	1.10
A1	0.00	0.05	0.10
A2	0.70	0.85	1.00
A3	0.25 BSC		
b	0.25	0.38	0.50
c	0.10	0.18	0.26
D	2.80	2.95	3.10
d	0.30 REF		
E	2.50	2.75	3.00
E1	1.30	1.50	1.70
e	0.95 BSC		
e1	1.90 BSC		
L1	0.60 REF		
L2	0.20	0.40	0.60
⊖	0°	--	10°

GENERIC
MARKING DIAGRAM*

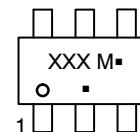

- XXX = Specific Device Code
- M = Date Code
- = Pb-Free Package

(Note: Microdot may be in either location)

*This information is generic. Please refer to device data sheet for actual part marking. Pb-Free indicator, "G" or microdot "▪", may or may not be present. Some products may not follow the Generic Marking.

DOCUMENT NUMBER:	98AON83292G	Electronic versions are uncontrolled except when accessed directly from the Document Repository. Printed versions are uncontrolled except when stamped "CONTROLLED COPY" in red.
DESCRIPTION:	TSOT23 6-Lead	PAGE 1 OF 1

onsemi and Onsemi are trademarks of Semiconductor Components Industries, LLC dba onsemi or its subsidiaries in the United States and/or other countries. onsemi reserves the right to make changes without further notice to any products herein. onsemi makes no warranty, representation or guarantee regarding the suitability of its products for any particular purpose, nor does onsemi assume any liability arising out of the application or use of any product or circuit, and specifically disclaims any and all liability, including without limitation special, consequential or incidental damages. onsemi does not convey any license under its patent rights nor the rights of others.

onsemi, **Onsemi**, and other names, marks, and brands are registered and/or common law trademarks of Semiconductor Components Industries, LLC dba "**onsemi**" or its affiliates and/or subsidiaries in the United States and/or other countries. **onsemi** owns the rights to a number of patents, trademarks, copyrights, trade secrets, and other intellectual property. A listing of **onsemi**'s product/patent coverage may be accessed at www.onsemi.com/site/pdf/Patent-Marking.pdf. **onsemi** reserves the right to make changes at any time to any products or information herein, without notice. The information herein is provided "as-is" and **onsemi** makes no warranty, representation or guarantee regarding the accuracy of the information, product features, availability, functionality, or suitability of its products for any particular purpose, nor does **onsemi** assume any liability arising out of the application or use of any product or circuit, and specifically disclaims any and all liability, including without limitation special, consequential or incidental damages. Buyer is responsible for its products and applications using **onsemi** products, including compliance with all laws, regulations and safety requirements or standards, regardless of any support or applications information provided by **onsemi**. "Typical" parameters which may be provided in **onsemi** data sheets and/or specifications can and do vary in different applications and actual performance may vary over time. All operating parameters, including "Typicals" must be validated for each customer application by customer's technical experts. **onsemi** does not convey any license under any of its intellectual property rights nor the rights of others. **onsemi** products are not designed, intended, or authorized for use as a critical component in life support systems or any FDA Class 3 medical devices or medical devices with a same or similar classification in a foreign jurisdiction or any devices intended for implantation in the human body. Should Buyer purchase or use **onsemi** products for any such unintended or unauthorized application, Buyer shall indemnify and hold **onsemi** and its officers, employees, subsidiaries, affiliates, and distributors harmless against all claims, costs, damages, and expenses, and reasonable attorney fees arising out of, directly or indirectly, any claim of personal injury or death associated with such unintended or unauthorized use, even if such claim alleges that **onsemi** was negligent regarding the design or manufacture of the part. **onsemi** is an Equal Opportunity/Affirmative Action Employer. This literature is subject to all applicable copyright laws and is not for resale in any manner.

ADDITIONAL INFORMATION

TECHNICAL PUBLICATIONS:

Technical Library: www.onsemi.com/design/resources/technical-documentation
onsemi Website: www.onsemi.com

ONLINE SUPPORT: www.onsemi.com/support

For additional information, please contact your local Sales Representative at www.onsemi.com/support/sales