

# MOSFET – N-Channel, SUPERFET® II

**800 V, 2.2 A, 4.3 Ω**

## FCPF4300N80Z

### Description

SUPERFET II MOSFET is onsemi’s brand–new high voltage super–junction (SJ) MOSFET family that is utilizing charge balance technology for outstanding low on–resistance and lower gate charge performance. This technology is tailored to minimize conduction loss, provide superior switching performance, dv/dt rate and higher avalanche energy. Consequently, SUPERFET II MOSFET is very suitable for the switching power applications such as Audio, Laptop adapter, Lighting, ATX power and industrial power applications.

### Features

- $R_{DS(on)} = 3.4 \text{ m}\Omega$  (Typ.)
- Ultra Low Gate Charge (Typ.  $Q_g = 6.8 \text{ nC}$ )
- Low  $E_{oss}$  (Typ.  $0.8 \mu\text{J @ 400 V}$ )
- Low Effective Output Capacitance (Typ.  $C_{oss(eff.)} = 36 \text{ pF}$ )
- 100% Avalanche Tested
- ESD Improved Capability
- RoHS Compliant

### Applications

- AC–DC Power Supply
- LED Lighting

$V_{DSS}$	$R_{DS(on)} \text{ MAX}$	$I_D \text{ MAX}$
800 V	$4.3 \Omega @ 10 \text{ V}$	2.2 A

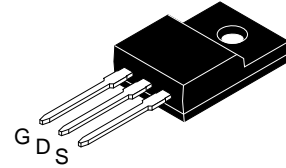

TO–220 Fullpack, 3–Lead / TO–220F–3SG  
 CASE 221AT

### MARKING DIAGRAM

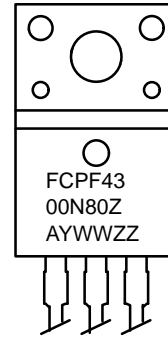

FCPF4300N80Z = Specific Device Code  
 A = Assembly Location  
 YWW = Date Code (Year & Week)  
 ZZ = Assembly Lot

### N-CHANNEL MOSFET

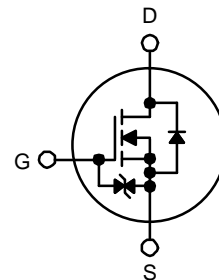

### ORDERING INFORMATION

Part Number	Package	Shipping
FCPF4300N80Z	TO–220F	1000 Units / Tube

# FCPF4300N80Z

## ABSOLUTE MAXIMUM RATINGS ( $T_C = 25^\circ\text{C}$ , unless otherwise noted)

Symbol	Parameter		FCPF4300N80Z	Unit
$V_{DSS}$	Drain to Source Voltage		800	V
$V_{GSS}$	Gate to Source Voltage	- DC	$\pm 20$	V
		- AC ( $f > 1$ Hz)	$\pm 30$	
$I_D$	Drain Current	- Continuous ( $T_C = 25^\circ\text{C}$ )	2.2*	A
		- Continuous ( $T_C = 100^\circ\text{C}$ )	1.4*	
$I_{DM}$	Drain Current	- Pulsed (Note 1)	3.2*	A
$E_{AS}$	Single Pulsed Avalanche Energy (Note 2)		8.2	mJ
$I_{AR}$	Avalanche Current (Note 1)		0.32	A
$E_{AR}$	Repetitive Avalanche Energy (Note 1)		0.19	mJ
dv/dt	MOSFET dv/dt		100	V/ns
	Peak Diode Recovery dv/dt (Note 3)		20	
$P_D$	Power Dissipation	( $T_C = 25^\circ\text{C}$ )	19.2	W
		- Derate Above $25^\circ\text{C}$	0.15	W/ $^\circ\text{C}$
$T_J, T_{STG}$	Operating and Storage Temperature Range		-55 to +150	$^\circ\text{C}$
$T_L$	Maximum Lead Temperature for Soldering, 1/8" from Case for 5 Seconds		300	$^\circ\text{C}$

Stresses exceeding those listed in the Maximum Ratings table may damage the device. If any of these limits are exceeded, device functionality should not be assumed, damage may occur and reliability may be affected.

\*Drain current limited by maximum junction temperature, with heatsink.

1. Repetitive rating; pulse width limited by maximum junction temperature.

2.  $I_{AS} = 0.32$  A,  $R_G = 25 \Omega$ , starting  $T_J = 25^\circ\text{C}$ .

3.  $I_{SD} \leq 2.2$  A,  $di/dt \leq 200$  A/ $\mu\text{s}$ ,  $V_{DD} \leq BV_{DSS}$ , starting  $T_J = 25^\circ\text{C}$ .

## THERMAL CHARACTERISTICS

Symbol	Parameter	FCPF4300N80Z	Unit
$R_{\theta JC}$	Thermal Resistance, Junction to Case, Max.	6.5	$^\circ\text{C}/\text{W}$
$R_{\theta JA}$	Thermal Resistance, Junction to Ambient, Max.	62.5	

# FCPF4300N80Z

## ELECTRICAL CHARACTERISTICS (T<sub>C</sub> = 25°C unless otherwise noted)

Symbol	Parameter	Test Conditions	Min	Typ	Max	Unit
<b>OFF CHARACTERISTICS</b>						
BV <sub>DSS</sub>	Drain to Source Breakdown Voltage	V <sub>GS</sub> = 0 V, I <sub>D</sub> = 1 mA, T <sub>J</sub> = 25°C	800	–	–	V
ΔBV <sub>DSS</sub> /ΔT <sub>J</sub>	Breakdown Voltage Temperature Coefficient	I <sub>D</sub> = 1 mA, Referenced to 25°C	–	0.85	–	V/°C
I <sub>DSS</sub>	Zero Gate Voltage Drain Current	V <sub>DS</sub> = 800 V, V <sub>GS</sub> = 0 V	–	–	25	μA
		V <sub>DS</sub> = 640 V, V <sub>GS</sub> = 0 V, T <sub>C</sub> = 125°C	–	–	250	
I <sub>GSS</sub>	Gate to Body Leakage Current	V <sub>GS</sub> = ±20 V, V <sub>DS</sub> = 0 V	–	–	±10	μA

## ON CHARACTERISTICS

V <sub>GS(th)</sub>	Gate Threshold Voltage	V <sub>GS</sub> = V <sub>DS</sub> , I <sub>D</sub> = 0.16 mA	2.5	–	4.5	V
R <sub>DS(on)</sub>	Static Drain to Source On Resistance	V <sub>GS</sub> = 10 V, I <sub>D</sub> = 0.8 A	–	3.4	4.3	Ω
g <sub>FS</sub>	Forward Transconductance	V <sub>DS</sub> = 20 V, I <sub>D</sub> = 0.8 A	–	0.52	–	S

## DYNAMIC CHARACTERISTICS

C <sub>iss</sub>	Input Capacitance	V <sub>DS</sub> = 100 V, V <sub>GS</sub> = 0 V, f = 1 MHz	–	267	355	pF
C <sub>oss</sub>	Output Capacitance		–	12	16	pF
C <sub>rss</sub>	Reverse Transfer Capacitance		–	0.78	–	pF
C <sub>oss</sub>	Output Capacitance	V <sub>DS</sub> = 480 V, V <sub>GS</sub> = 0 V, f = 1 MHz	–	6.2	–	pF
C <sub>oss(eff.)</sub>	Effective Output Capacitance	V <sub>DS</sub> = 0 V to 480 V, V <sub>GS</sub> = 0 V	–	36	–	pF
Q <sub>g(tot)</sub>	Total Gate Charge at 10 V	V <sub>DS</sub> = 640 V, I <sub>D</sub> = 1.6 A, V <sub>GS</sub> = 10 V (Note 4)	–	6.8	8.8	nC
Q <sub>gs</sub>	Gate to Source Gate Charge		–	1.38	–	nC
Q <sub>gd</sub>	Gate to Drain “Miller” Charge		–	3.0	–	nC
ESR	Equivalent Series Resistance	f = 1 MHz	–	2.9	–	Ω

## SWITCHING CHARACTERISTICS

t <sub>d(on)</sub>	Turn-On Delay Time	V <sub>DD</sub> = 400 V, I <sub>D</sub> = 1.6 A, V <sub>GS</sub> = 10 V, R <sub>g</sub> = 4.7 Ω (Note 4)	–	10	30	ns
t <sub>r</sub>	Turn-On Rise Time		–	6.5	23	ns
t <sub>d(off)</sub>	Turn-Off Delay Time		–	21	52	ns
t <sub>f</sub>	Turn-Off Fall Time		–	16	42	ns

## DRAIN-SOURCE DIODE CHARACTERISTICS

I <sub>S</sub>	Maximum Continuous Drain to Source Diode Forward Current	–	–	2.2	A	
I <sub>SM</sub>	Maximum Pulsed Drain to Source Diode Forward Current	–	–	3.2	A	
V <sub>SD</sub>	Drain to Source Diode Forward Voltage	V <sub>GS</sub> = 0 V, I <sub>SD</sub> = 1.6 A	–	–	1.2	V
t <sub>rr</sub>	Reverse Recovery Time	V <sub>GS</sub> = 0 V, I <sub>SD</sub> = 1.6 A, df/dt = 100 A/μs	–	209	–	ns
Q <sub>rr</sub>	Reverse Recovery Charge		–	1.2	–	μC

Product parametric performance is indicated in the Electrical Characteristics for the listed test conditions, unless otherwise noted. Product performance may not be indicated by the Electrical Characteristics if operated under different conditions.

4. Essentially independent of operating temperature typical characteristics.

TYPICAL PERFORMANCE CHARACTERISTICS

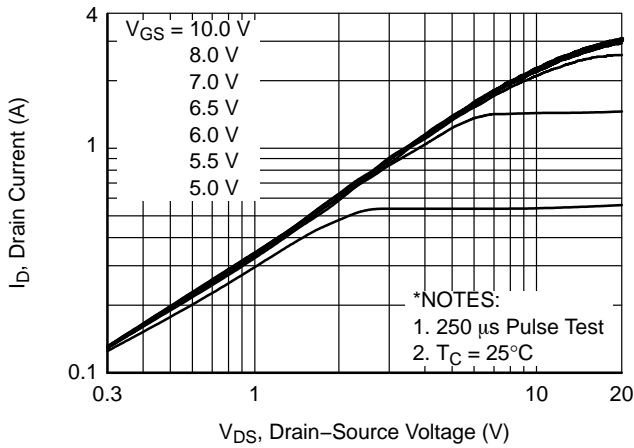

Figure 1. On-Region Characteristics

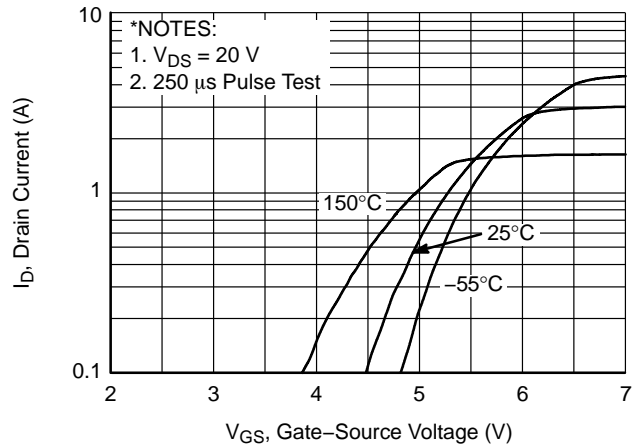

Figure 2. Transfer Characteristics

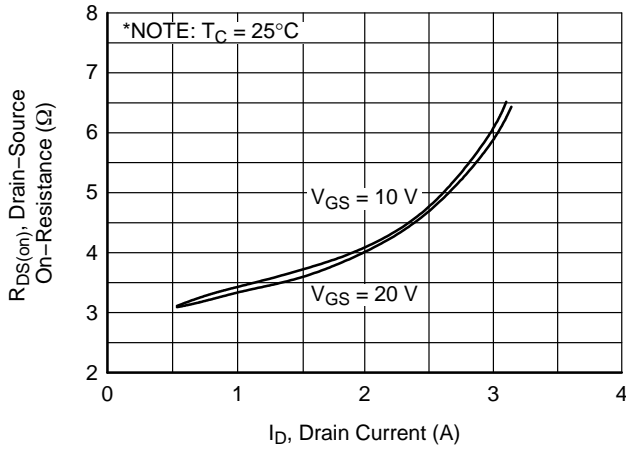

Figure 3. On-Resistance Variation vs. Drain Current and Gate Voltage

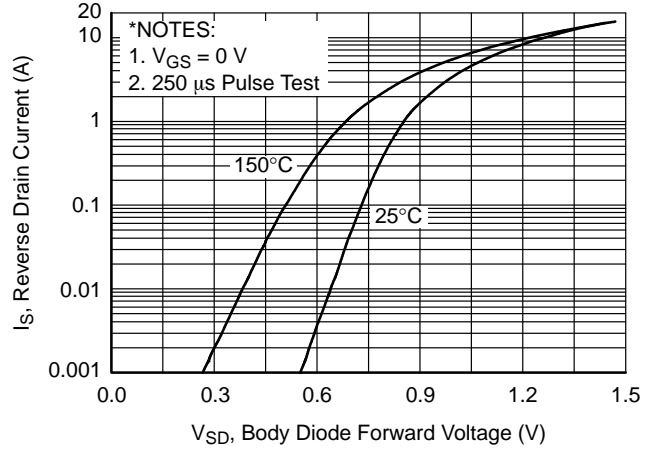

Figure 4. Body Diode Forward Voltage Variation vs. Source Current and Temperature

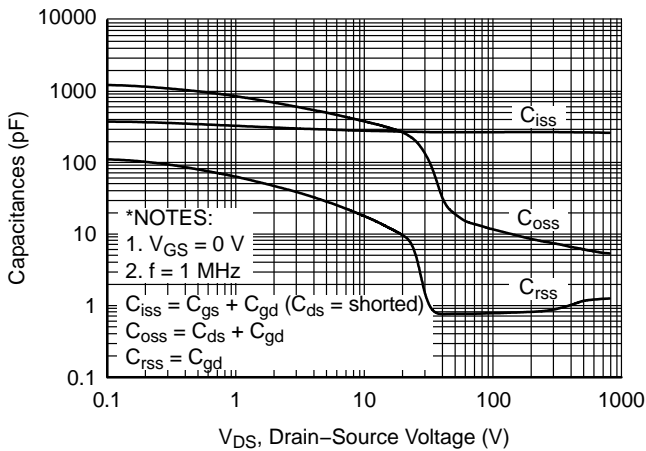

Figure 5. Capacitance Characteristics

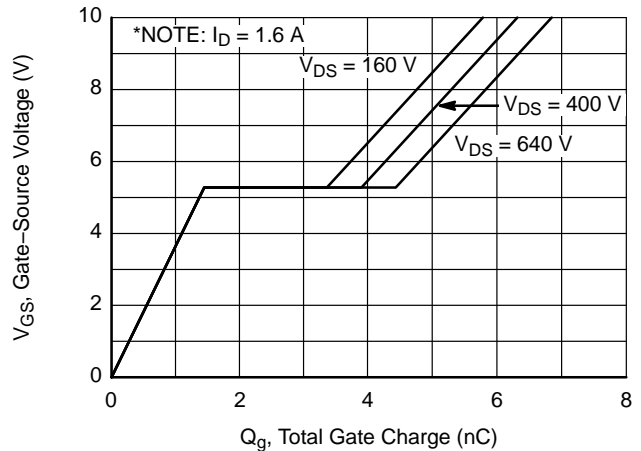

Figure 6. Gate Charge Characteristics

TYPICAL PERFORMANCE CHARACTERISTICS (CONTINUED)

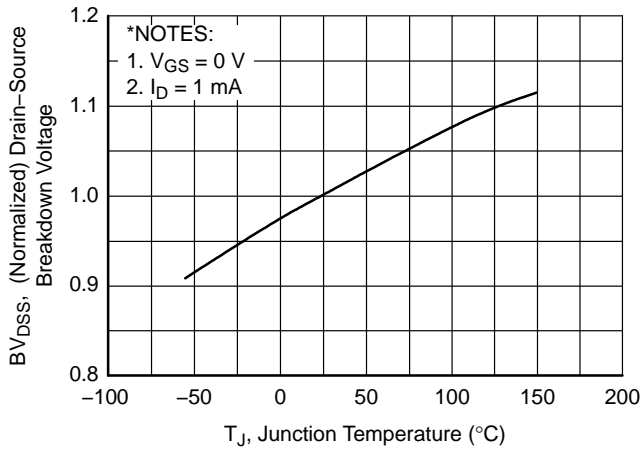

Figure 7. Breakdown Voltage Variation vs. Temperature

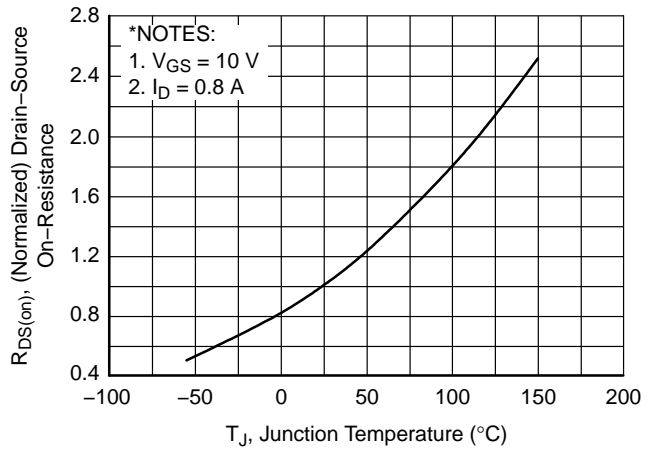

Figure 8. On-Resistance Variation vs. Temperature

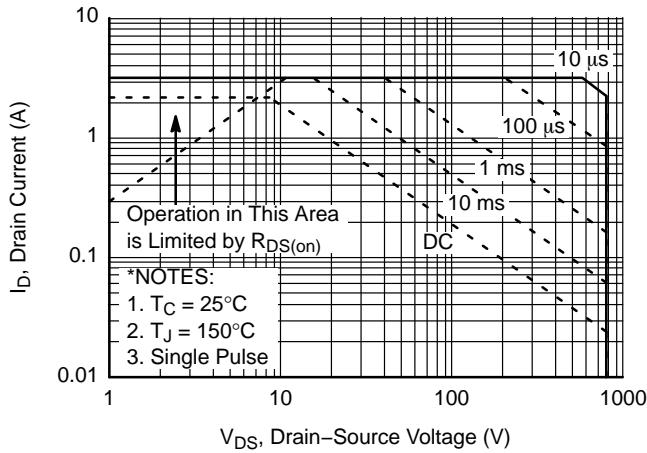

Figure 9. Maximum Safe Operating Area

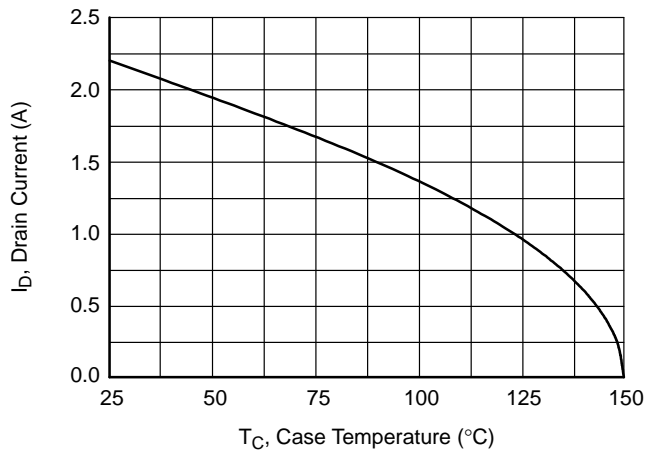

Figure 10. Maximum Drain Current vs. Case Temperature

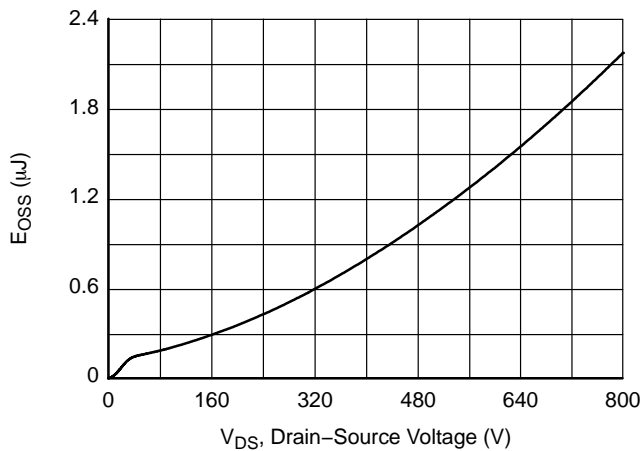

Figure 11.  $E_{OSS}$  vs. Drain to Source Voltage

# FCPF4300N80Z

## TYPICAL PERFORMANCE CHARACTERISTICS (CONTINUED)

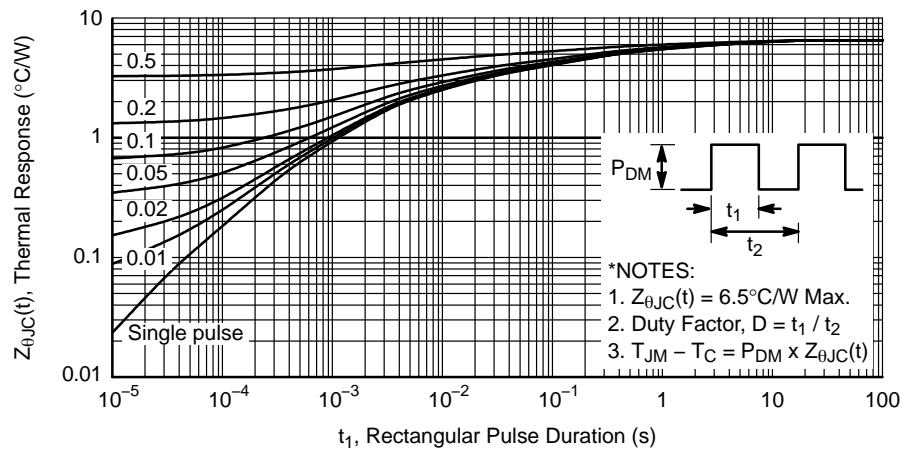

Figure 12. Transient Thermal Response Curve

# FCPF4300N80Z

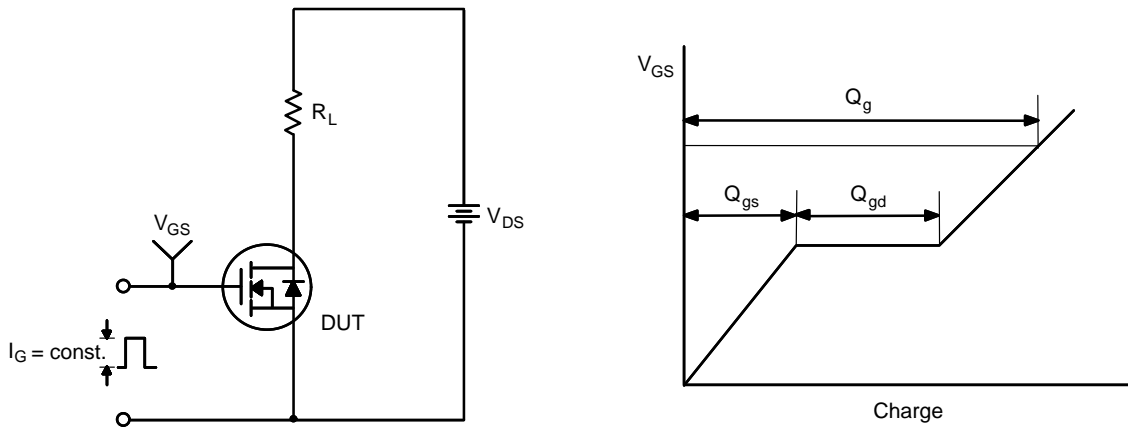

Figure 13. Gate Charge Test Circuit & Waveform

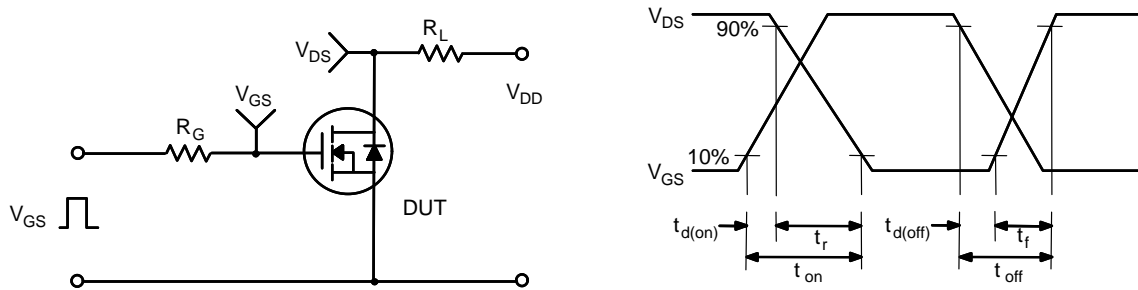

Figure 14. Resistive Switching Test Circuit & Waveforms

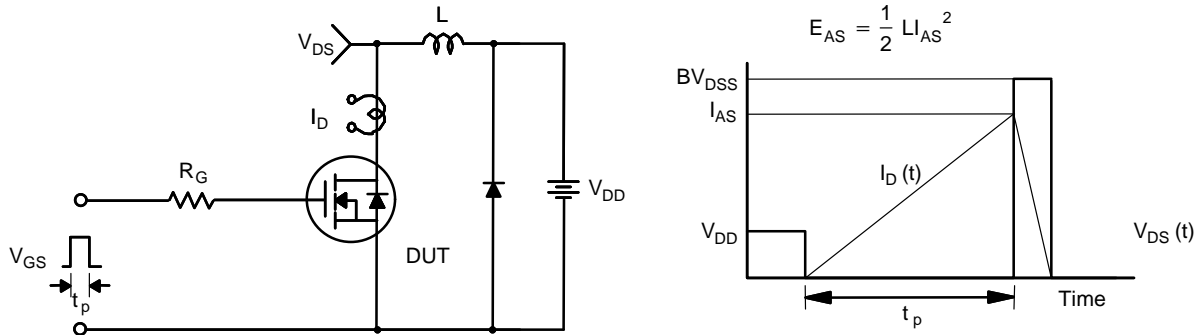
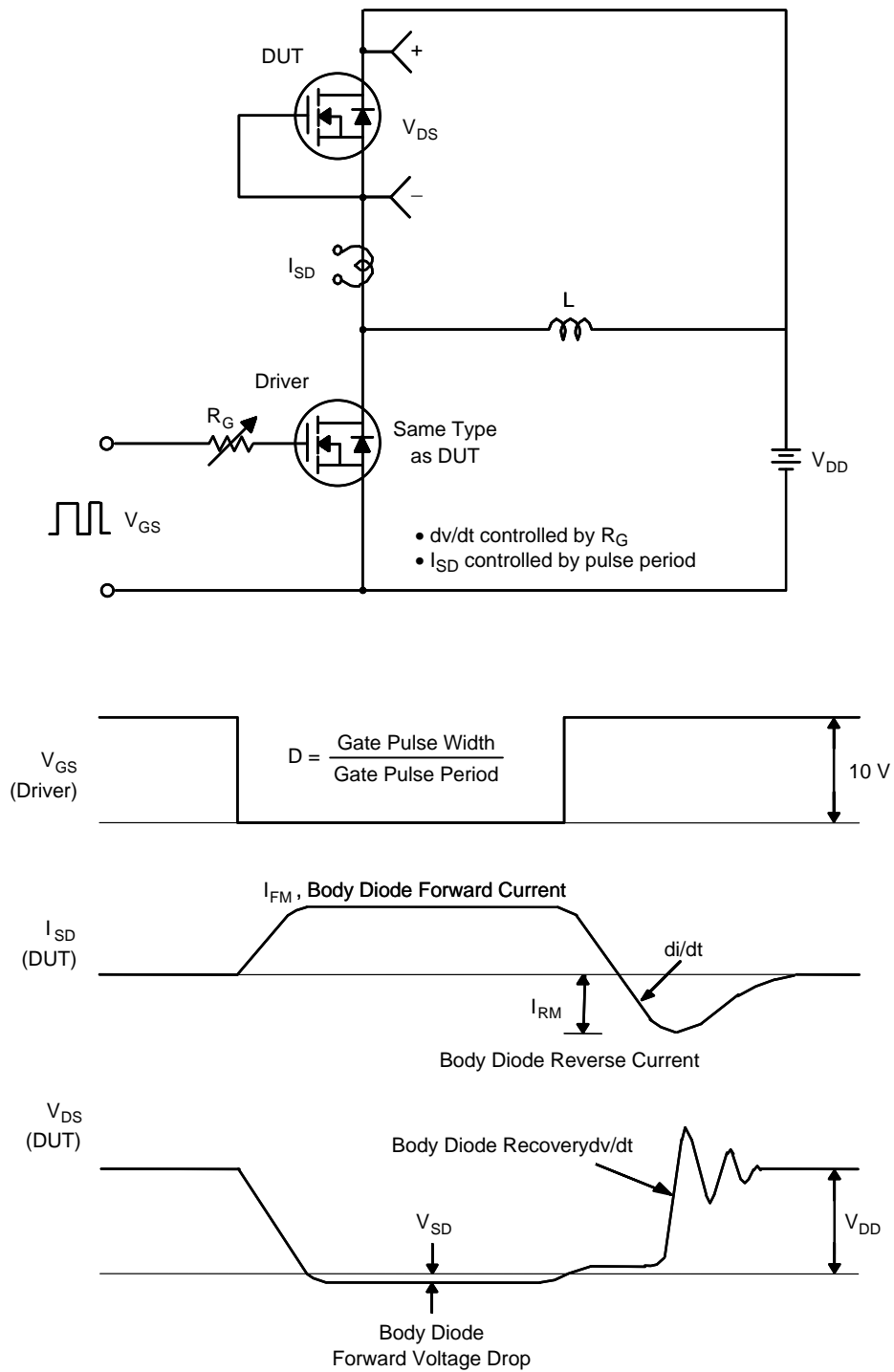

Figure 15. Unclamped Inductive Switching Test Circuit & Waveforms

# FCPF4300N80Z

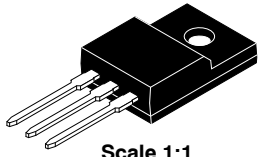

**Figure 16. Peak Diode Recovery  $dv/dt$  Test Circuit & Waveforms**



**TO-220 Fullpack, 3-Lead / TO-220F-3SG**  
**CASE 221AT**  
**ISSUE B**

DATE 19 JAN 2021



Scale 1:1

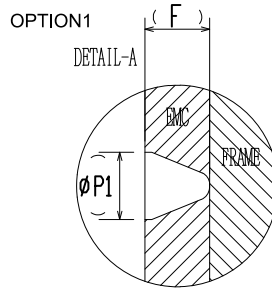
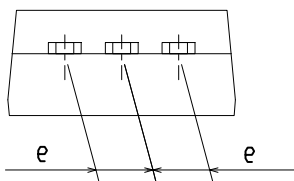

DIM	MILLIMETERS		
	MIN	NOM	MAX
A	4.50	4.70	4.90
A1	2.56	2.76	2.96
A2	2.34	2.54	2.74
b	0.70	0.80	0.90
b2	~	~	1.47
c	0.45	0.50	0.60
D	15.67	15.87	16.07
D1	15.60	15.80	16.00
E	9.96	10.16	10.36
e	2.34	2.54	2.74
F	~	0.84	~
H1	6.48	6.68	6.88
L	12.78	12.98	13.18
L1	3.03	3.23	3.43
Ø P	2.98	3.18	3.38
Ø P1	~	1.00	~
Q	3.20	3.30	3.40

**NOTES:**

- A. DIMENSION AND TOLERANCE AS ASME Y14.5-2009
- B. DIMENSIONS ARE EXCLUSIVE OF BURRS, MOLD FLASH AND TIE BAR PROTRUCTIONS.
- C. OPTION 1 - WITH SUPPORT PIN HOLE  
OPTION 2 - NO SUPPORT PIN HOLE

<b>DOCUMENT NUMBER:</b>	<b>98AON67439E</b>	Electronic versions are uncontrolled except when accessed directly from the Document Repository. Printed versions are uncontrolled except when stamped "CONTROLLED COPY" in red.
<b>DESCRIPTION:</b>	<b>TO-220 FULLPACK, 3-LEAD / TO-220F-3SG</b>	<b>PAGE 1 OF 1</b>

onsemi and ONSEMI are trademarks of Semiconductor Components Industries, LLC dba onsemi or its subsidiaries in the United States and/or other countries. onsemi reserves the right to make changes without further notice to any products herein. onsemi makes no warranty, representation or guarantee regarding the suitability of its products for any particular purpose, nor does onsemi assume any liability arising out of the application or use of any product or circuit, and specifically disclaims any and all liability, including without limitation special, consequential or incidental damages. onsemi does not convey any license under its patent rights nor the rights of others.

**onsemi**, **Onsemi**, and other names, marks, and brands are registered and/or common law trademarks of Semiconductor Components Industries, LLC dba "**onsemi**" or its affiliates and/or subsidiaries in the United States and/or other countries. **onsemi** owns the rights to a number of patents, trademarks, copyrights, trade secrets, and other intellectual property. A listing of **onsemi**'s product/patent coverage may be accessed at [www.onsemi.com/site/pdf/Patent-Marking.pdf](http://www.onsemi.com/site/pdf/Patent-Marking.pdf). **onsemi** reserves the right to make changes at any time to any products or information herein, without notice. The information herein is provided "as-is" and **onsemi** makes no warranty, representation or guarantee regarding the accuracy of the information, product features, availability, functionality, or suitability of its products for any particular purpose, nor does **onsemi** assume any liability arising out of the application or use of any product or circuit, and specifically disclaims any and all liability, including without limitation special, consequential or incidental damages. Buyer is responsible for its products and applications using **onsemi** products, including compliance with all laws, regulations and safety requirements or standards, regardless of any support or applications information provided by **onsemi**. "Typical" parameters which may be provided in **onsemi** data sheets and/or specifications can and do vary in different applications and actual performance may vary over time. All operating parameters, including "Typicals" must be validated for each customer application by customer's technical experts. **onsemi** does not convey any license under any of its intellectual property rights nor the rights of others. **onsemi** products are not designed, intended, or authorized for use as a critical component in life support systems or any FDA Class 3 medical devices or medical devices with a same or similar classification in a foreign jurisdiction or any devices intended for implantation in the human body. Should Buyer purchase or use **onsemi** products for any such unintended or unauthorized application, Buyer shall indemnify and hold **onsemi** and its officers, employees, subsidiaries, affiliates, and distributors harmless against all claims, costs, damages, and expenses, and reasonable attorney fees arising out of, directly or indirectly, any claim of personal injury or death associated with such unintended or unauthorized use, even if such claim alleges that **onsemi** was negligent regarding the design or manufacture of the part. **onsemi** is an Equal Opportunity/Affirmative Action Employer. This literature is subject to all applicable copyright laws and is not for resale in any manner.

## ADDITIONAL INFORMATION

### TECHNICAL PUBLICATIONS:

Technical Library: [www.onsemi.com/design/resources/technical-documentation](http://www.onsemi.com/design/resources/technical-documentation)  
onsemi Website: [www.onsemi.com](http://www.onsemi.com)

### ONLINE SUPPORT: [www.onsemi.com/support](http://www.onsemi.com/support)

For additional information, please contact your local Sales Representative at [www.onsemi.com/support/sales](http://www.onsemi.com/support/sales)