

Half Bridge Gate Driver

FAN7080-GF085



SOIC8
CASE 751EB

Description

The FAN7080-GF085 is a half-bridge gate drive IC with reset input and adjustable dead time control. It is designed for high voltage and high speed driving of MOSFET or IGBT, which operates up to 600 V. onsemi's high-voltage process and common-mode noise cancellation technique provide stable operation in the high side driver under high-dV/dt noise circumstances. An advanced level-shift circuit allows high-side gate driver operation up to $V_S = -5$ V (typical) at $V_{BS} = 15$ V. Logic input is compatible with standard CMOS outputs. The UVLO circuits for both channels prevent from malfunction when V_{CC} and V_{BS} are lower than the specified threshold voltage. Combined pin function for dead time adjustment and reset shutdown make this IC packaged with space saving SOIC-8 Package. Minimum source and sink current capability of output driver is 250 mA and 500 mA respectively, which is suitable for junction box application and half and full bridge application in the motor drive system.

Features

- Automotive Qualified to AEC-Q100 and PPAP Capable
- Floating Channel for Bootstrap Operation to +600 V
- Tolerance to Negative Transient Voltage on VS Pin
- VS-pin dv/dt Immune
- Gate Drive Supply Range from 5.5 V to 20 V
- Under-Voltage Lockout (UVLO)
- CMOS Schmitt-triggered Inputs with Pull-down
- High Side Output In-phase with Input
- IN input is 3.3 V/5 V Logic Compatible and Available on 15 V Input
- Matched Propagation Delay for both Channels
- Dead Time Adjustable
- These Devices are Pb-Free and are RoHS Compliant

Applications

- Junction Box
- Half and Full Bridge Application in the Motor Drive System

MARKING DIAGRAM

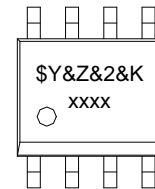

- \$Y = onsemi Logo
- &Z = Assembly Plant Code
- &2 = 2-Digit Date Code
- &K = Lot Run Traceability Code
- xxxx = Specific Device Code

ORDERING INFORMATION

Device	Package	Shipping†
FAN7080M-GF085	SOIC8 (Pb-Free)	9500 / Tube
FAN7080MX-GF085		2500 / Tape & Reel

†For information on tape and reel specifications, including part orientation and tape sizes, please refer to our Tape and Reel Packaging Specification Brochure, [BRD8011/D](#).

FAN7080-GF085

TYPICAL APPLICATION

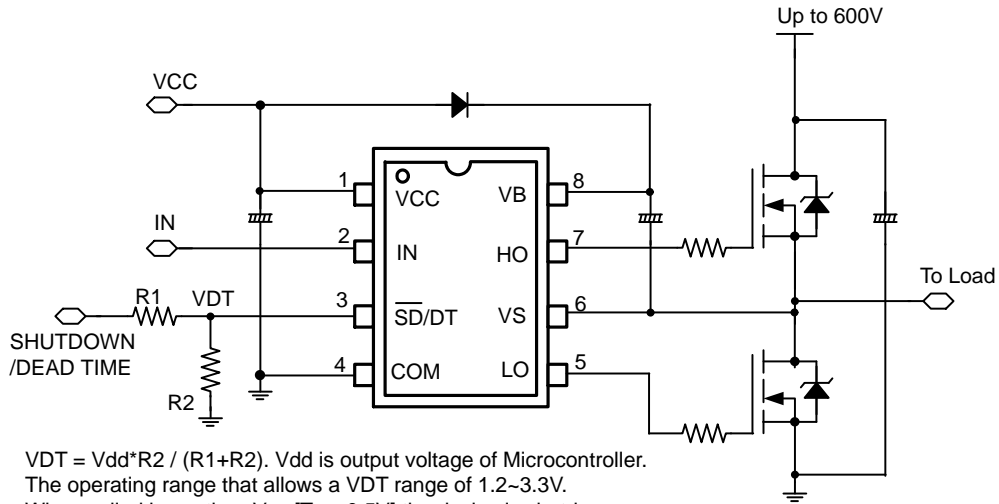

$VDT = V_{dd} * R2 / (R1 + R2)$. V_{dd} is output voltage of Microcontroller.
 The operating range that allows a VDT range of 1.2~3.3V.
 When pulled lower than V_{DT} [Typ. 0.5V] the device is shutdown.
 Care must be taken to avoid below threshold spikes on pin 3 that can cause undesired shut down of the IC.
 For this reason the connection of the components between pin 3 and ground has to be as short as possible.
 And a capacitor (Typ. 0.02 μ F) between pin3 and COM can prevent this spike. This pin can not be left floating for the same reason.

Figure 1. Typical Application

BLOCK DIAGRAM

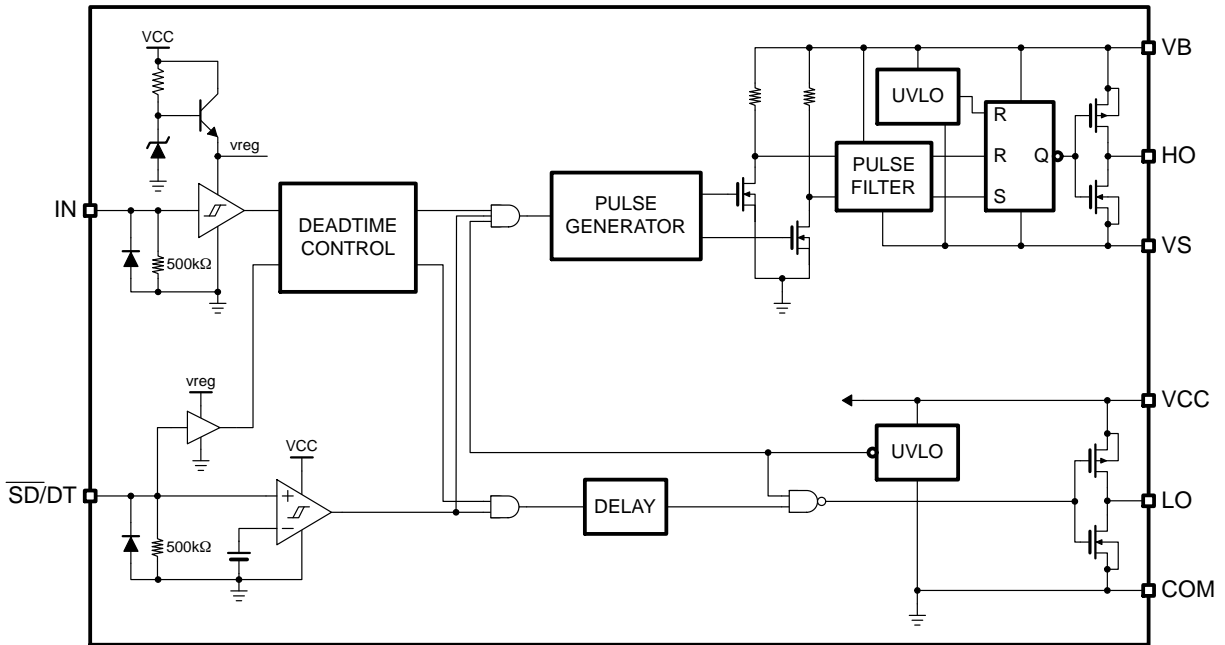

Figure 2. Block Diagram

FAN7080–GF085

PIN CONFIGURATION

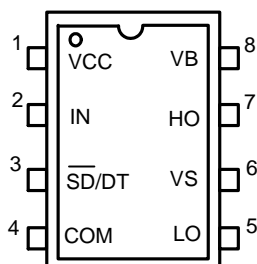

Figure 3. Pin Assignment (Top Through View)

PIN DESCRIPTIONS

Pin #	Name	I/O	Pin Function Description
1	V _{CC}	P	Driver Supply Voltage
2	IN	I	Logic input for high and low side gate drive output
3	SD/DT	I	Shutdown Input and dead time setting
4	COM	P	Ground
5	LO	A	Low side gate drive output for MOSFET Gate connection
6	V _S	A	High side floating offset for MOSFET Source connection
7	HO	A	High side drive output for MOSFET Gate connection
8	V _B	P	Driver Output Stage Supply

ABSOLUTE MAXIMUM RATINGS

Symbol	Characteristics	Min.	Max.	Unit
V _S	High-Side Floating Offset Voltage	V _B -25	V _B +0.3	V
V _B	High-Side Floating Supply Voltage	-0.3	625	V
V _{HO}	High-Side Floating Output Voltage	V _S -0.3	V _B +0.3	V
V _{LO}	Low-Side Floating Output Voltage	-0.3	V _{CC} +0.3	V
V _{CC}	Supply Voltage	-0.3	25	V
V _{IN}	Input Voltage for IN	-0.3	V _{CC} +0.3	V
I _{IN}	Input Injection Current (Note 1)		+1	mA
P _D	Power Dissipation (Notes 2, 3)		0.625	W
θ _{JA}	Thermal Resistance, Junction to Ambient (Note 2)		200	°C/W
T _J	Junction Temperature		150	°C
T _{STG}	Storage Temperature	-55	150	°C
ESD	Human Body Model (HBM)		1000	V
	Charge Device Model (CDM)		500	

Stresses exceeding those listed in the Maximum Ratings table may damage the device. If any of these limits are exceeded, device functionality should not be assumed, damage may occur and reliability may be affected.

1. Guaranteed by design. Full function, no latchup. Tested at 10 V and 17 V.

2. The Thermal Resistance and power dissipation rating are measured per below conditions:

JESD51-2: Integral circuits thermal test method environmental conditions, natural convection/Still Air

JESD51-3: Low effective thermal conductivity test board for leaded surface-mount packages.

3. Do not exceed power dissipation (P_D) under any circumstances.

FAN7080–GF085

RECOMMENDED OPERATING CONDITIONS

Symbol	Characteristics	Min.	Max.	Unit
V _{BS} (Note 4)	High–Side Floating Supply Voltage (DC) Transient: –10 V at 0.1 μs	V _S +6	V _S +20	V
V _S	High–Side Floating Supply Offset Voltage (DC) Transient: –25 V(max.) at 0.1 μs at V _{BS} < 25 V	–5	600	V
V _{HO}	High–Side Output Voltage	V _S	V _B	V
V _{LO}	Low–Side Output Voltage	0	V _{CC}	V
V _{CC}	Supply Voltage for Logic Input	5.5	20	V
V _{IN}	Logic Input Voltage	0	V _{CC}	V
dv/dt	Allowable Offset Voltage Slew Rate (Note 5)		50	V/ns
T _{PULSE}	Minimum Pulse Width (Notes 5, 6)	1100		ns
F _S	Switching Frequency (Note 6)		200	kHz
T _A	Operating Ambient Temperature	–40	125	°C

Functional operation above the stresses listed in the Recommended Operating Ranges is not implied. Extended exposure to stresses beyond the Recommended Operating Ranges limits may affect device reliability.

4. The V_S offset is tested with all supplies based at 15 V differential

5. Guaranteed by design.

6. When V_{DT} = 1.2 V. Refer to Figures 5, 6, 7 and 8.

ELECTRICAL CHARACTERISTICS

(Unless otherwise specified –40°C ≤ T_A ≤ 125°C, V_{CC} = 15 V, V_{BS} = 15 V, V_S = 0 V, C_L = 1 nF)

Symbol	Parameter	Conditions	Min.	Typ.	Max.	Unit
--------	-----------	------------	------	------	------	------

V_{CC} and V_{BS} Supply Characteristics

V _{CCUV+} V _{BSUV+}	V _{CC} and V _{BS} Supply Under–Voltage Positive going Threshold			4.2	5.5	V
V _{CCUV–} V _{BSUV–}	V _{CC} and V _{BS} Supply Under–Voltage Negative going Threshold		2.8	3.6		V
V _{CCUVH} V _{BSUVH}	V _{CC} and V _{BS} Supply Under–Voltage Hysteresis		0.2	0.6		V
t _{DUVCC} t _{DUVBS}	Under–Voltage Lockout Response Time	V _{CC} : 6 V→2.5 V or 2.5 V→6 V V _{BS} : 6 V→2.5 V or 2.5 V→6 V	0.5		20	μs
			0.5		20	
I _{LK}	Offset Supply Leakage Current	V _B = V _S = 600 V		20	50	μA
I _{QBS}	Quiescent V _{BS} Supply Current	V _{IN} = 0 or 5 V, V _S DT = 1.2 V	20	75	150	μA
I _{QCC}	Quiescent V _{CC} Supply Current	V _{IN} = 0 or 5 V, V _S DT = 1.2 V		350	1000	μA

Input Characteristics

V _{IH}	High Logic level Input Voltage		2.7			V
V _{IL}	Low Logic Level Input Voltage				0.8	V
I _{IIN+}	Logic Input High Bias Current	V _{IN} = 5 V		10	50	μA
I _{IIN–}	Logic Input Low Bias Current	V _{IN} = 0 V		0	2	μA
V _{DT}	V _{DT} Dead Time Setting Range		1.2		5.0	V
V _{SD}	V _{SD} Shutdown Threshold Voltage			0.8	1.2	V
R _S DT	High Logic Level Resistance for \overline{SD} /DT	V _S DT = 5 V	100	500	1100	kΩ
I _S DT–	Low Logic Level Input bias Current for \overline{SD} /DT	V _S DT = 0 V		1	2	μA

Output Characteristics

V _{OH} (HO)	High Level Output Voltage (V _{CC} – V _{HO})	I _O = 0			0.1	V
V _{OL} (HO)	Low Level Output Voltage (V _{HO})	I _O = 0			0.1	V
I _{O+} (HO)	Output High, Short–Circuit Pulse Current		250	300		mA

FAN7080–GF085

ELECTRICAL CHARACTERISTICS (continued)

(Unless otherwise specified $-40^{\circ}\text{C} \leq T_A \leq 125^{\circ}\text{C}$, $V_{CC} = 15\text{ V}$, $V_{BS} = 15\text{ V}$, $V_S = 0\text{ V}$, $C_L = 1\text{ nF}$)

Symbol	Parameter	Conditions	Min.	Typ.	Max.	Unit
Output Characteristics						
IO-(HO)	Output Low , Short-Circuit Pulse Current		500	600		mA
ROP(HO)	Equivalent Output Resistance				60	Ω
RON(HO)					30	
VOH(LO)	High Level Output Voltage ($V_B - V_{LO}$)	IO = 0			0.1	V
VOL(LO)	Low Level Output Voltage (V_{LO})	IO = 0			0.1	V
IO+(LO)	Output High, Short-Circuit Pulse Current		250			mA
IO-(LO)	Output Low , Short-Circuit Pulse Current		500			mA
ROP(LO)	Equivalent Output Resistance				60	Ω
RON(LO)					30	

Product parametric performance is indicated in the Electrical Characteristics for the listed test conditions, unless otherwise noted. Product performance may not be indicated by the Electrical Characteristics if operated under different conditions.

DYNAMIC ELECTRICAL CHARACTERISTICS

(Unless otherwise specified $-40^{\circ}\text{C} \leq T_A \leq 125^{\circ}\text{C}$, $V_{CC} = 15\text{ V}$, $V_{BS} = 15\text{ V}$, $V_S = 0\text{ V}$, $C_L = 1\text{ nF}$)

Symbol	Parameter	Conditions	Min.	Typ.	Max.	Unit
t _{ON}	Turn-On Propagation Delay (Note 7)	V _S = 0 V		750	1500	ns
t _{OFF}	Turn-Off Propagation Delay	V _S = 0 V		130	250	ns
t _R	Turn-On Rise Time			40	150	ns
t _F	Turn-Off Fall Time			25	400	ns
D _T	Dead Time, LS Turn-off to HS Turn-on and HS Turn-on to LS Turn-off	V _{IN} = 0 or 5 V at VDT = 1.2 V	250	650	1200	ns
		V _{IN} = 0 or 5 V at VDT = 1.2 V	1600	2100	2600	
MDT	Dead Time Matching Time	DT1 – DT2 at VDT = 1.2 V		35	110	ns
		DT1 – DT2 at VDT = 3.3 V			300	
M _{TON}	Delay Matching, HS and LS Turn-on	VDT = 1.2 V		25	110	ns
M _{TOFF}	Delay Matching, HS and LS Turn-off	VDT = 1.2 V		15	60	ns
t _{SD}	Shutdown Propagation Delay			180	330	ns
FS1	Switching Frequency	V _{CC} = V _{BS} = 20 V			200	kHz
FS2		V _{CC} = V _{BS} = 5.5 V			200	

7. t_{ON} includes DT

FAN7080-GF085

TYPICAL WAVEFORMS

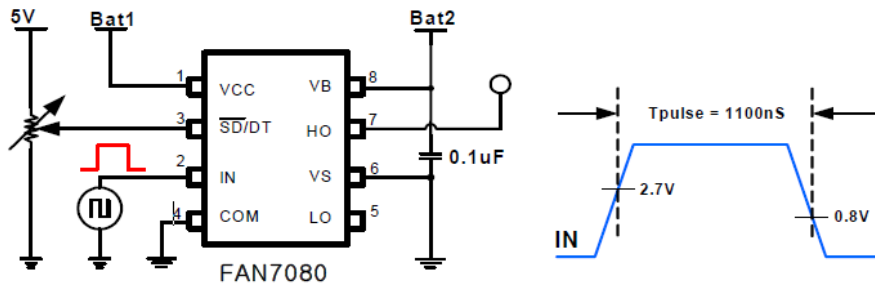

Figure 4. Short Pulse Width Test Circuit and Pulse Width Waveform

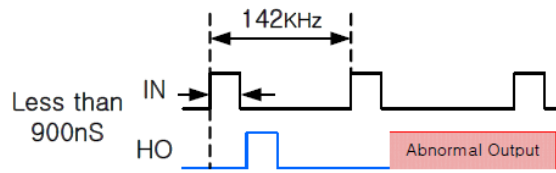

Figure 5. Abnormal Output Waveform with Pulse Width

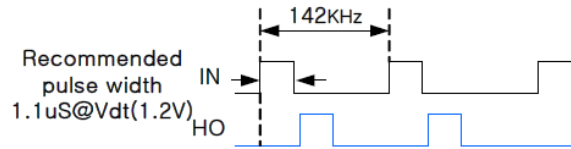

Figure 6. Recommendation of Pulse Width Output Waveform

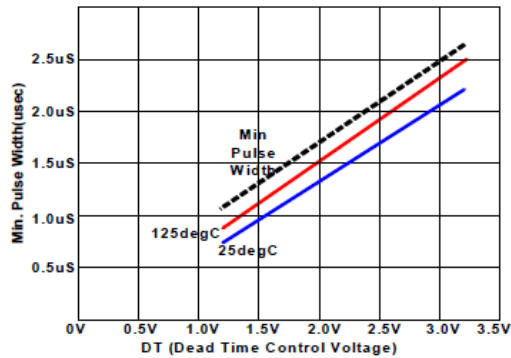

Figure 7. Pulse Width vs. V_{DT}

TYPICAL PERFORMANCE CHARACTERISTICS

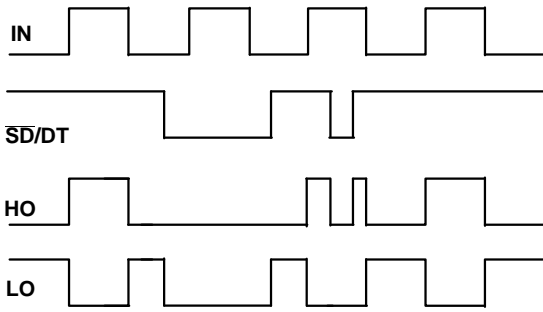

Figure 8. Input/Output Timing Diagram

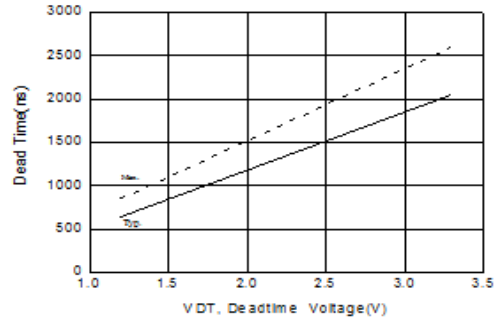
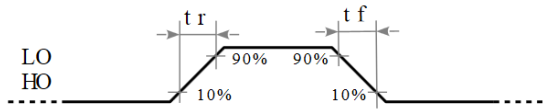

Figure 9. Dead Time vs. V_{DT}
($V_{CC} = V_{BS} = 15\text{ V}$, $-40^{\circ}\text{C} < T_J < 125^{\circ}\text{C}$)



Note: not drawn to scale

Figure 10. Switching Time Waveform Definitions

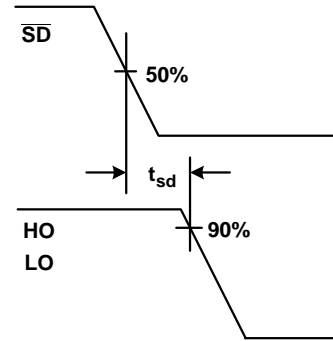

Figure 11. Shutdown Waveform Definitions

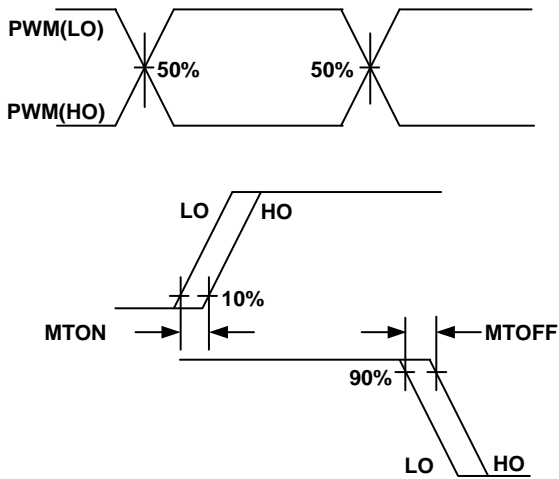
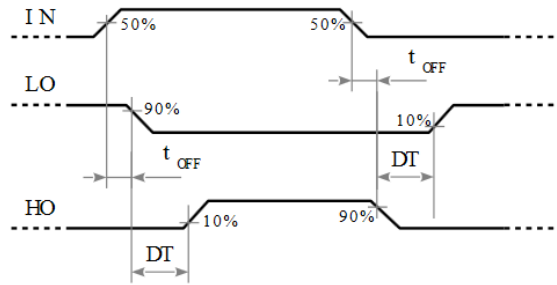

Figure 12. Delay Matching Waveform Definitions



Note: not drawn to scale

Figure 13. Dead Time Waveform Definitions

TYPICAL PERFORMANCE CHARACTERISTICS (continued)

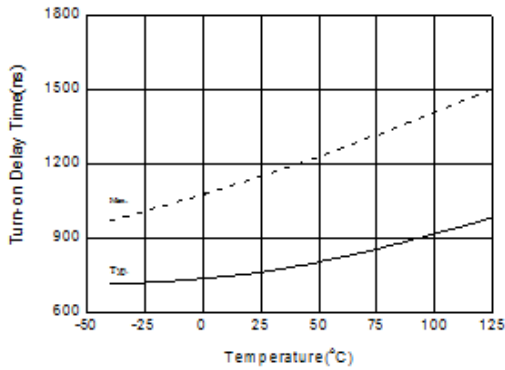

Figure 14. Turn-On Delay Time of HO vs. Temperature ($V_{CC} = V_{BS} = 15\text{ V}$, $C_L = 1\text{ nF}$)

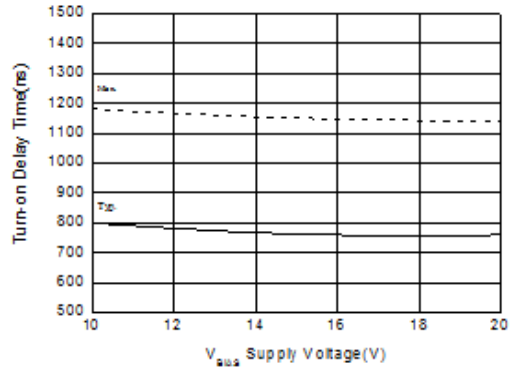

Figure 15. Turn-On Delay Time of HO vs. V_{BS} Supply Voltage ($V_{CC} = 15\text{ V}$, $C_L = 1\text{ nF}$, $T_A = 25^\circ\text{C}$)

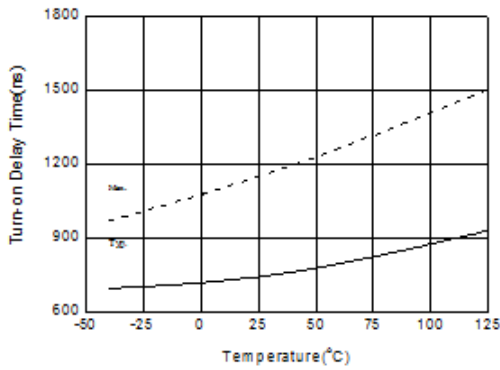

Figure 16. Turn-On Delay Time of LO vs. Temperature ($V_{CC} = V_{BS} = 15\text{ V}$, $C_L = 1\text{ nF}$)

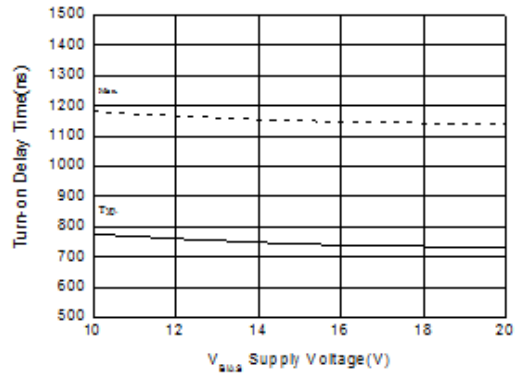

Figure 17. Turn-On Delay Time of LO vs. V_{BS} Supply Voltage ($V_{CC} = 15\text{ V}$, $C_L = 1\text{ nF}$, $T_A = 25^\circ\text{C}$)

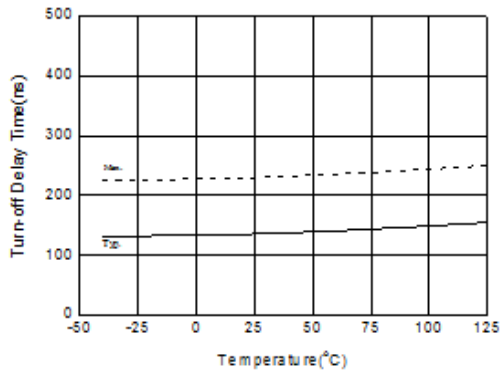

Figure 18. Turn-Off Delay Time of HO vs. Temperature ($V_{CC} = V_{BS} = 15\text{ V}$, $C_L = 1\text{ nF}$)

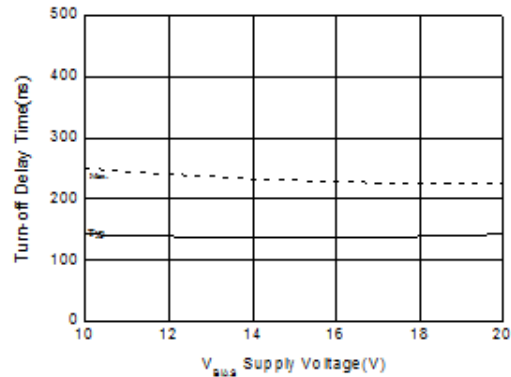

Figure 19. Turn-Off Delay Time of HO vs. V_{BS} Supply Voltage ($V_{CC} = 15\text{ V}$, $C_L = 1\text{ nF}$, $T_A = 25^\circ\text{C}$)

TYPICAL PERFORMANCE CHARACTERISTICS (continued)

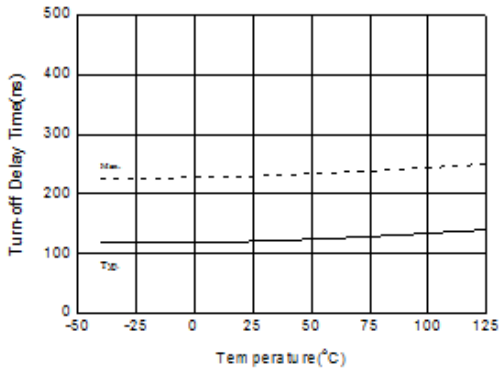

Figure 20. Turn-Off Delay Time of LO vs. Temperature ($V_{CC} = V_{BS} = 15\text{ V}$, $C_L = 1\text{ nF}$)

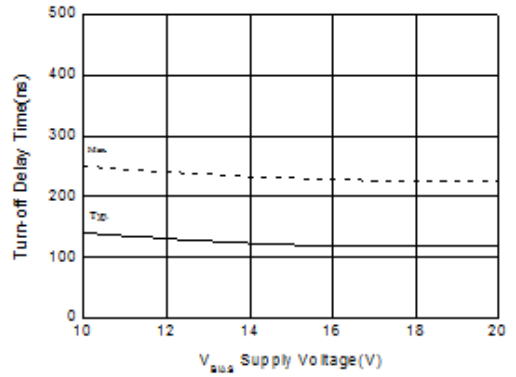

Figure 21. Turn-Off Delay Time of HO vs. V_{BS} Supply Voltage ($V_{CC} = 15\text{ V}$, $C_L = 1\text{ nF}$, $T_A = 25^\circ\text{C}$)

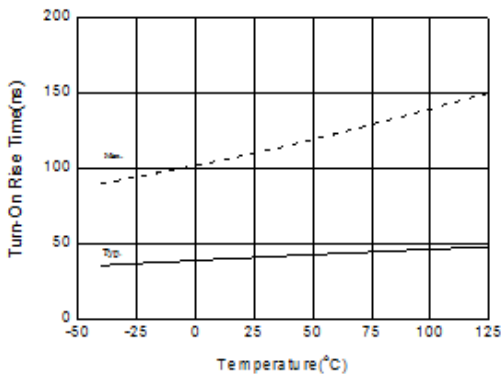

Figure 22. Turn-On Rise Time of HO vs. Temperature ($V_{CC} = V_{BS} = 15\text{ V}$, $C_L = 1\text{ nF}$)

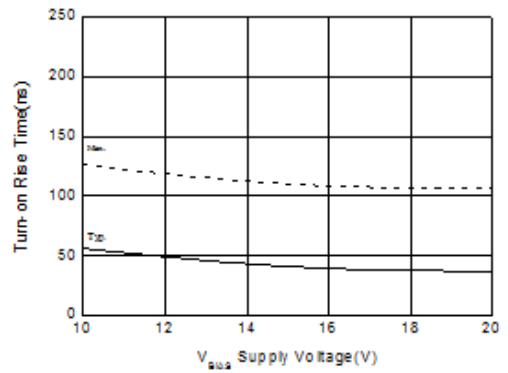

Figure 23. Turn-On Rise Time of HO vs. V_{BS} Supply Voltage ($V_{CC} = 15\text{ V}$, $C_L = 1\text{ nF}$, $T_A = 25^\circ\text{C}$)

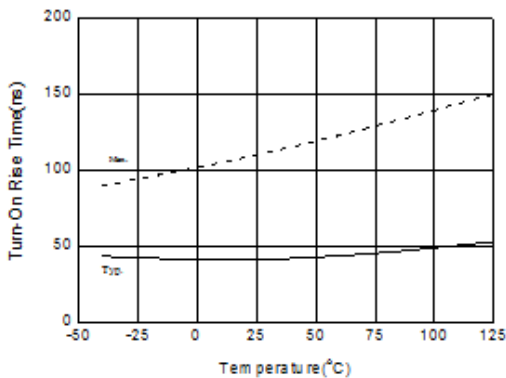

Figure 24. Turn-On Rise Time of LO vs. Temperature ($V_{CC} = V_{BS} = 15\text{ V}$, $C_L = 1\text{ nF}$)

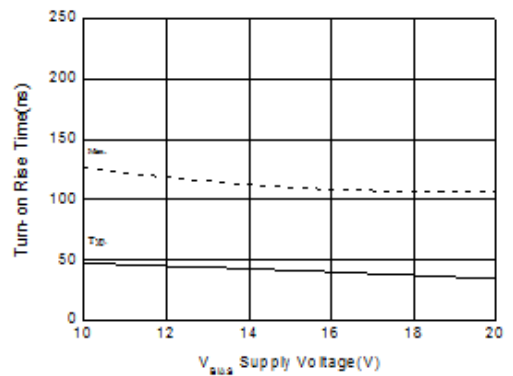

Figure 25. Turn-On Rise Time of LO vs. V_{BS} Supply Voltage ($V_{CC} = 15\text{ V}$, $C_L = 1\text{ nF}$, $T_A = 25^\circ\text{C}$)

TYPICAL PERFORMANCE CHARACTERISTICS (continued)

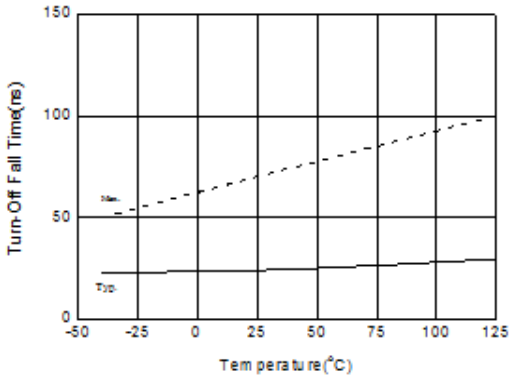

Figure 26. Turn–Off Fall Time of HO vs. Temperature ($V_{CC} = V_{BS} = 15\text{ V}$, $C_L = 1\text{ nF}$)

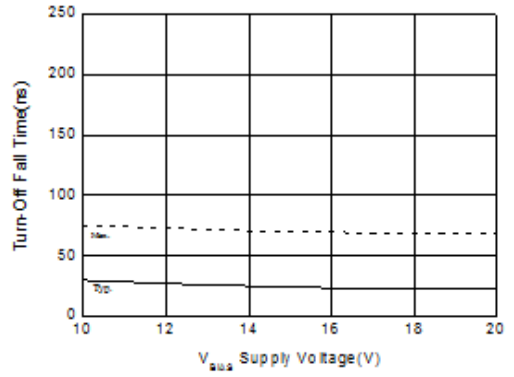

Figure 27. Turn–Off Fall Time of HO vs. V_{BS} Supply Voltage ($V_{CC} = 15\text{ V}$, $C_L = 1\text{ nF}$, $T_A = 25^\circ\text{C}$)

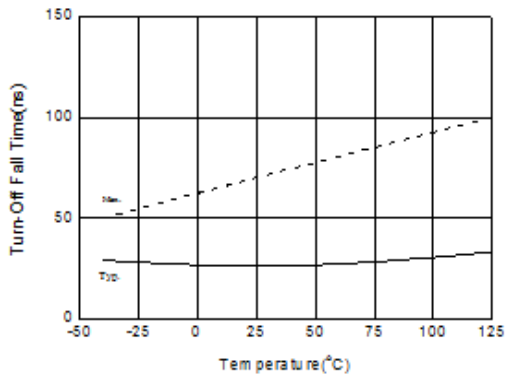

Figure 28. Turn–Off Fall Time of LO vs. Temperature ($V_{CC} = V_{BS} = 15\text{ V}$, $C_L = 1\text{ nF}$)

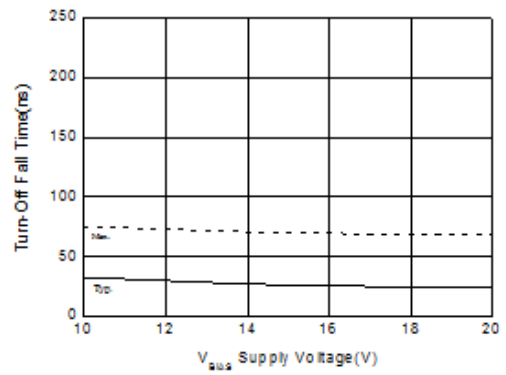

Figure 29. Turn–Off Fall Time of LO vs. V_{BS} Supply Voltage ($V_{CC} = 15\text{ V}$, $C_L = 1\text{ nF}$, $T_A = 25^\circ\text{C}$)

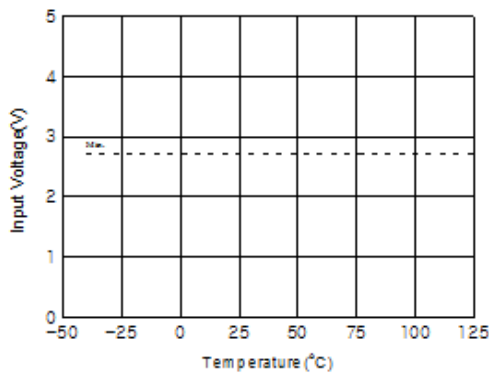

Figure 30. Logic Low Input Voltage vs. Temperature

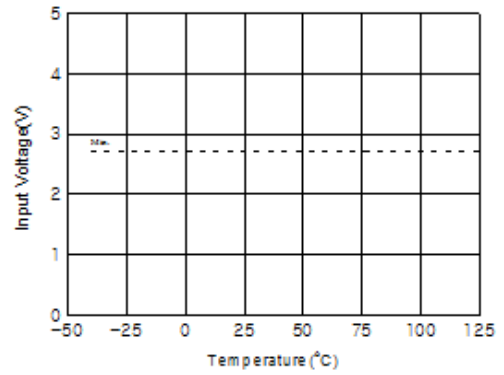

Figure 31. Logic High Input Voltage vs. Temperature

TYPICAL PERFORMANCE CHARACTERISTICS (continued)

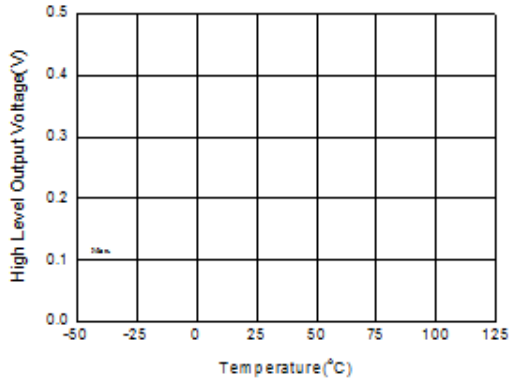

Figure 32. High Level Output of HO vs. Temperature ($V_{CC} = V_{BS} = 15\text{ V}$)

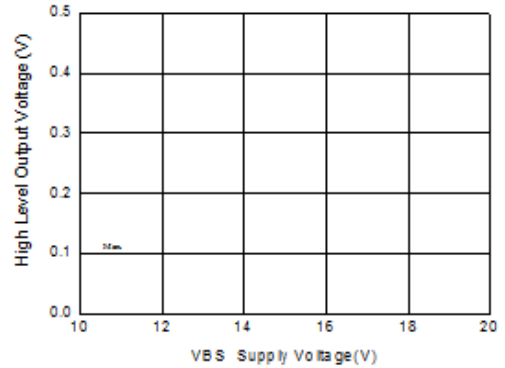

Figure 33. High Level Output of HO vs. V_{BS} Supply Voltage ($V_{CC} = 15\text{ V}$, $T_A = 25^\circ\text{C}$)

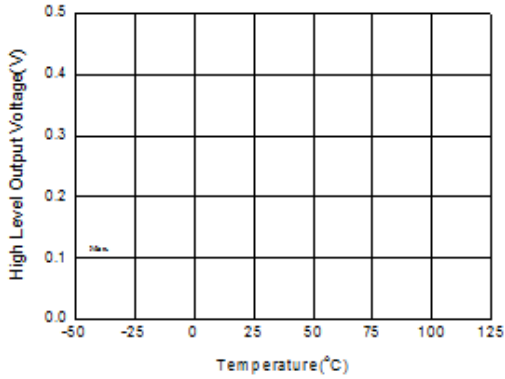

Figure 34. High Level Output of LO vs. Temperature ($V_{CC} = V_{BS} = 15\text{ V}$)

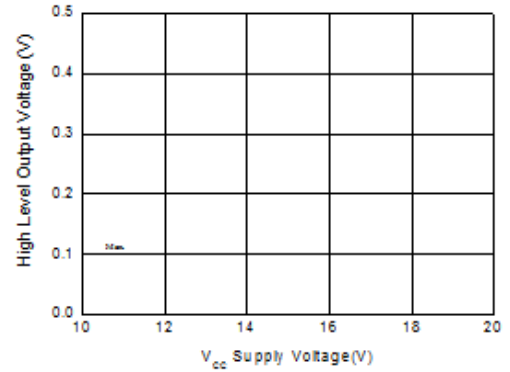

Figure 35. High Level Output of LO vs. V_{BS} Supply Voltage ($V_{CC} = 15\text{ V}$, $T_A = 25^\circ\text{C}$)

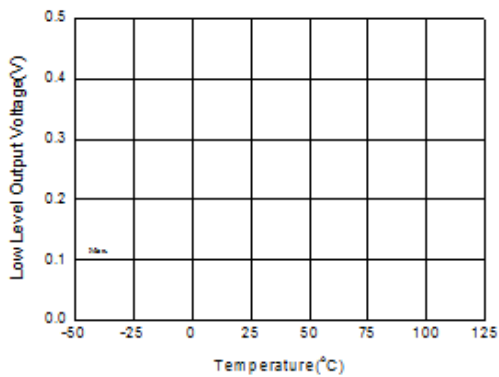

Figure 36. Low Level Output of HO vs. Temperature ($V_{CC} = V_{BS} = 15\text{ V}$)

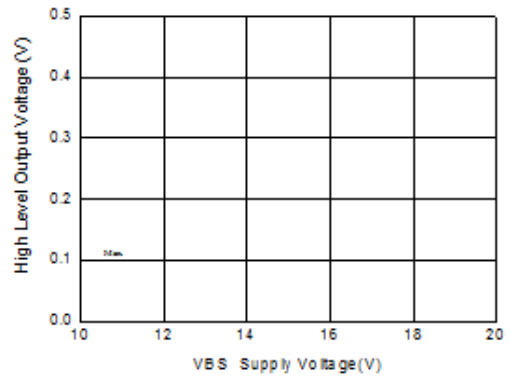

Figure 37. Low Level Output of HO vs. V_{BS} Supply Voltage ($V_{CC} = 15\text{ V}$, $T_A = 25^\circ\text{C}$)

TYPICAL PERFORMANCE CHARACTERISTICS (continued)

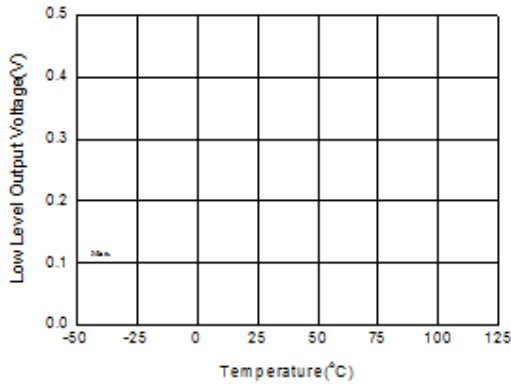

Figure 38. Low Level Output of LO vs. Temperature ($V_{CC} = V_{BS} = 15\text{ V}$)

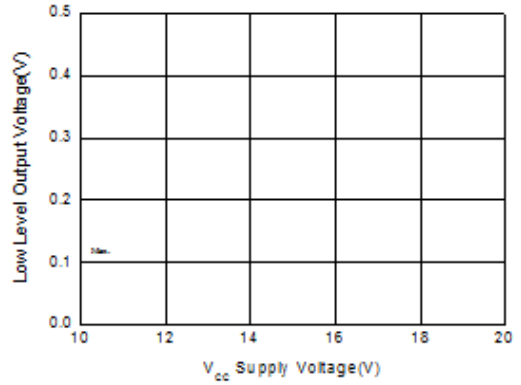

Figure 39. Low Level Output of LO vs. V_{CC} Supply Voltage ($V_{CC} = 15\text{ V}$, $T_A = 25^\circ\text{C}$)

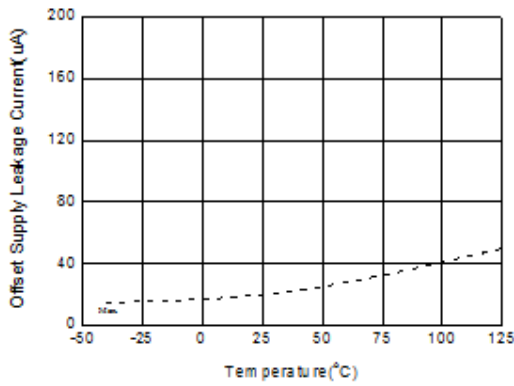

Figure 40. Offset Supply Leakage Current vs. Temperature ($V_{CC} = V_{BS} = 600\text{ V}$)

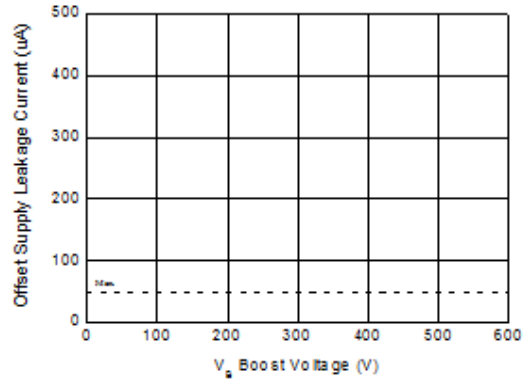

Figure 41. Offset Supply Leakage Current vs. V_B Boost Voltage ($V_{CC} = 15\text{ V}$, $T_A = 25^\circ\text{C}$)

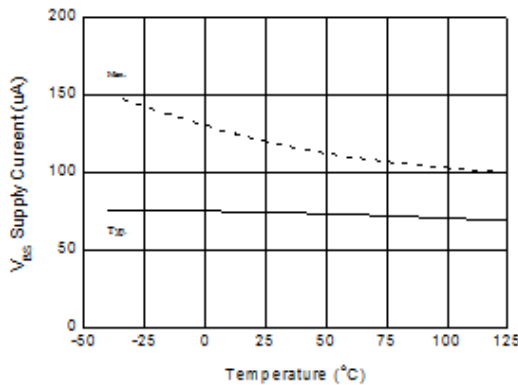

Figure 42. V_{BS} Supply Current vs. Temperature ($V_{BS} = 15\text{ V}$)

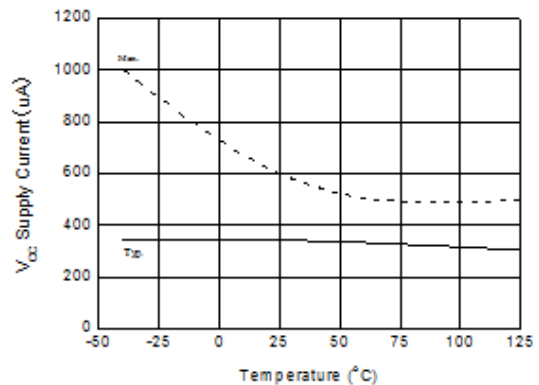

Figure 43. V_{CC} Supply Current vs. Temperature ($V_{CC} = 15\text{ V}$)

TYPICAL PERFORMANCE CHARACTERISTICS (continued)

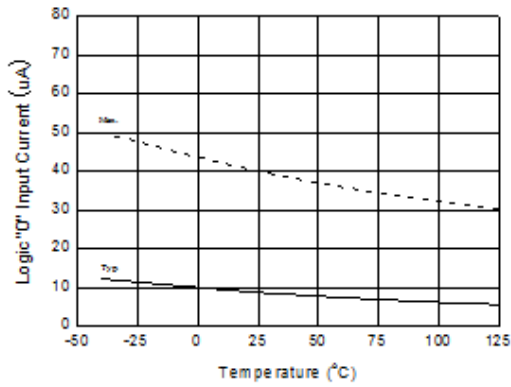

Figure 44. Logic High Input Current vs. Temperature ($V_{IN} = 5\text{ V}$)

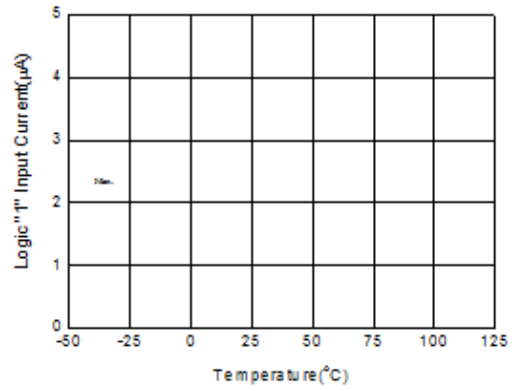

Figure 45. Logic Low Input Current vs. Temperature ($V_{IN} = 5\text{ V}$)

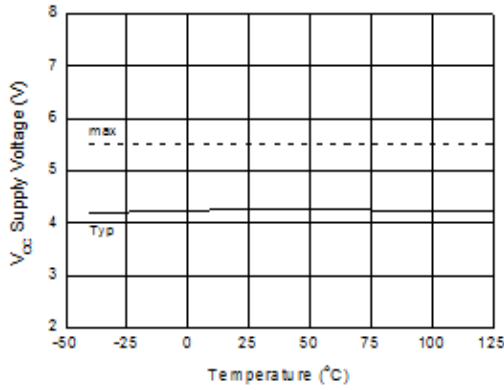

Figure 46. V_{CC} Under-Voltage Threshold (+) vs. Temperature

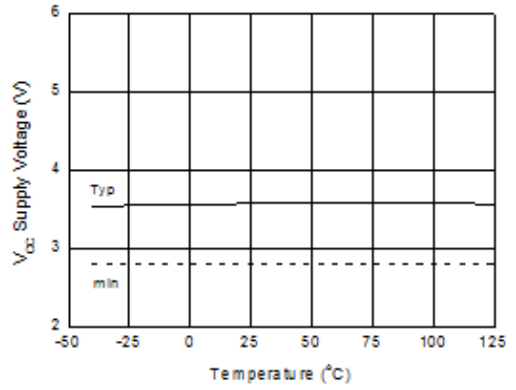

Figure 47. V_{CC} Under-Voltage Threshold (-) vs. Temperature

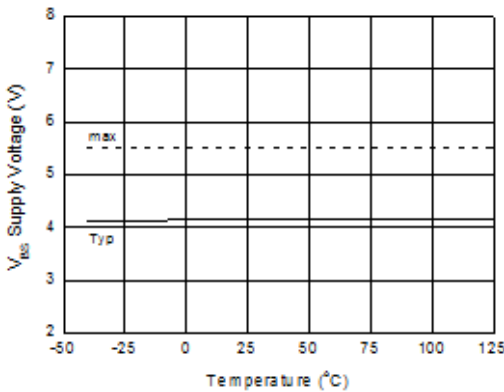

Figure 48. V_{BS} Under-Voltage Threshold (+) vs. Temperature

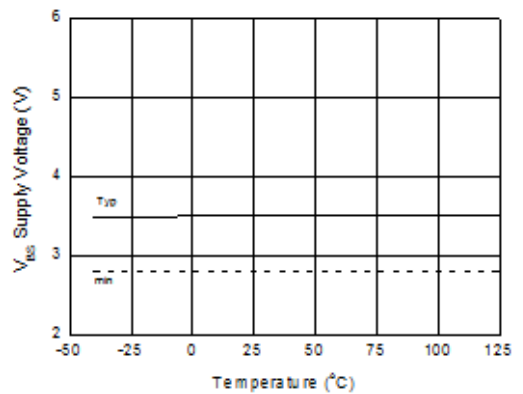

Figure 49. V_{BS} Under-Voltage Threshold (-) vs. Temperature

TYPICAL PERFORMANCE CHARACTERISTICS (continued)

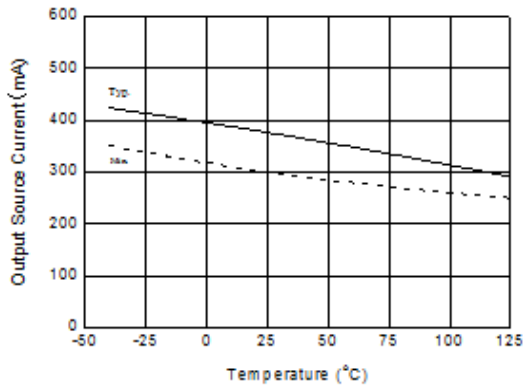

Figure 50. Output Source Current of HO vs. Temperature ($V_{CC} = V_{BS} = 15\text{ V}$)

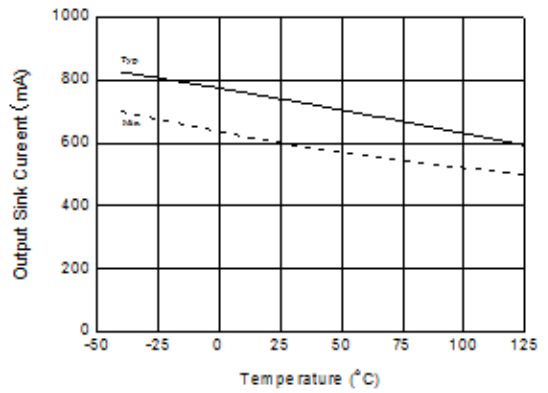

Figure 51. Output Sink Current of HO vs. Temperature ($V_{CC} = V_{BS} = 15\text{ V}$)

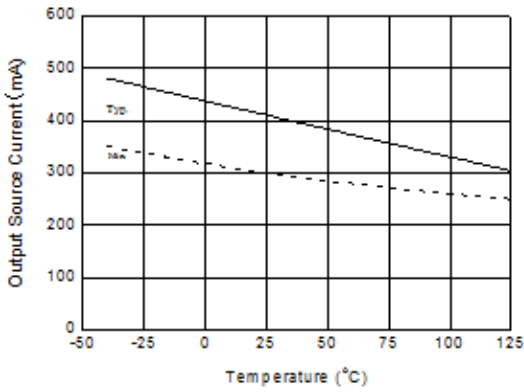

Figure 52. Output Source Current of LO vs. Temperature ($V_{CC} = V_{BS} = 15\text{ V}$)

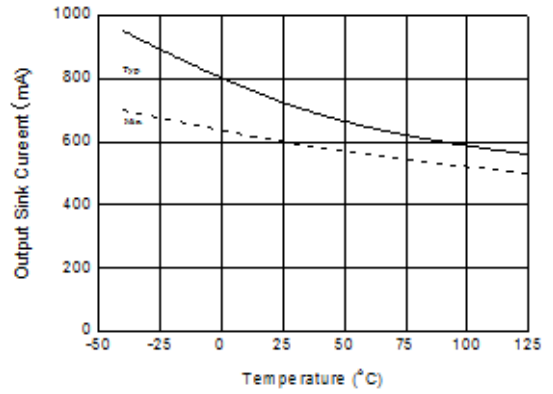

Figure 53. Output Sink Current of LO vs. Temperature ($V_{CC} = V_{BS} = 15\text{ V}$)

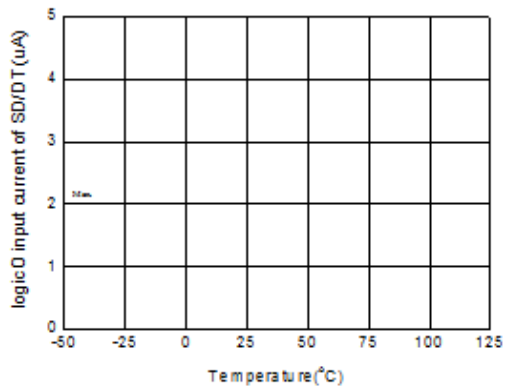

Figure 54. Logic Low Input Current of \overline{SD}/DT vs. Temperature

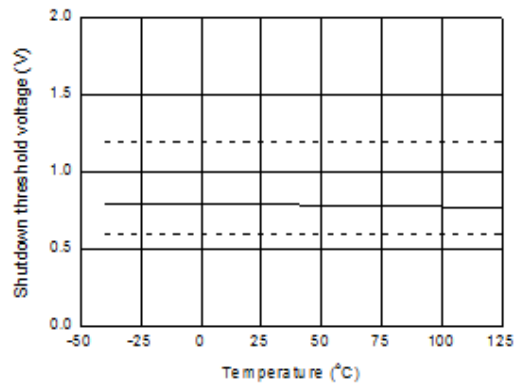

Figure 55. Shutdown Threshold Voltage vs. Temperature

TYPICAL PERFORMANCE CHARACTERISTICS (continued)

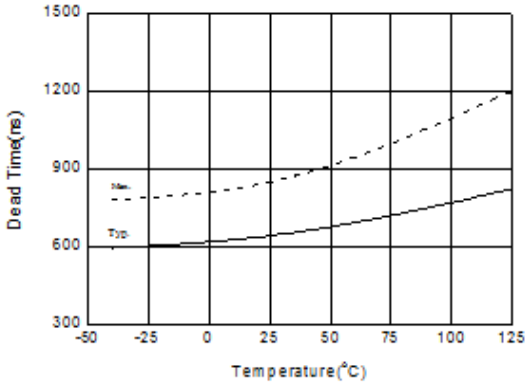

Figure 56. Deadtime vs. Temperature ($V_{CC} = V_{BS} = 15\text{ V}$, $V_{DT} = 1.2\text{ V}$)

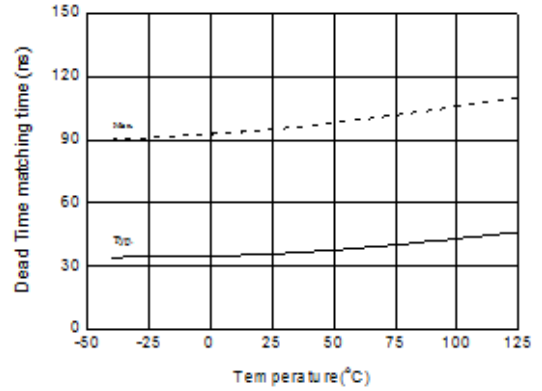

Figure 57. Deadtime Matching Time vs. Temperature ($V_{CC} = V_{BS} = 15\text{ V}$, $V_{DT} = 1.2\text{ V}$)

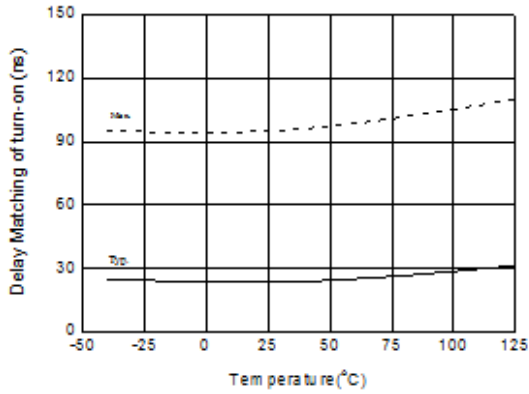

Figure 58. Turn-on Delay Matching vs. Temperature ($V_{CC} = V_{BS} = 15\text{ V}$, $V_{DT} = 1.2\text{ V}$)

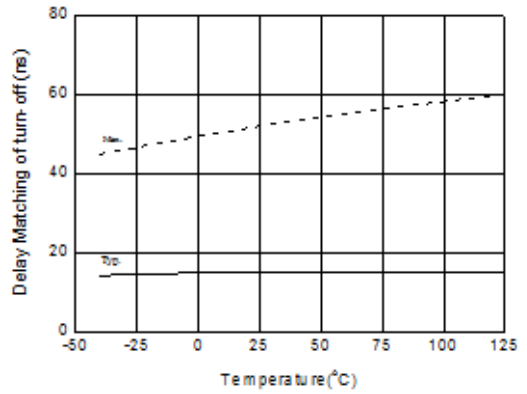

Figure 59. Turn-off Delay Matching vs. Temperature ($V_{CC} = V_{BS} = 15\text{ V}$, $V_{DT} = 1.2\text{ V}$)

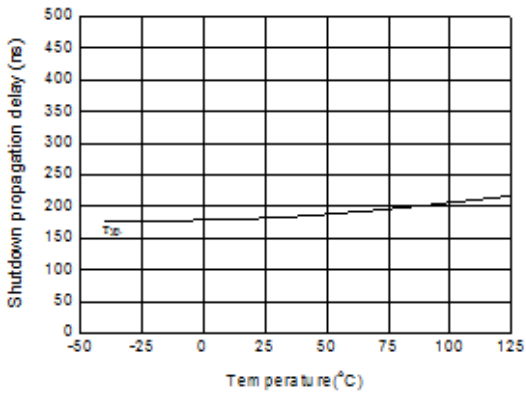

Figure 60. Shutdown Propagation Delay vs. Temperature

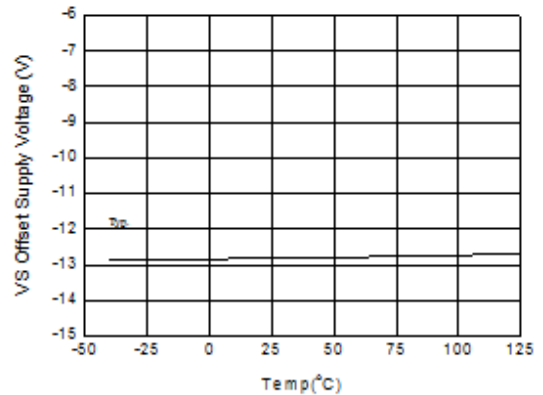
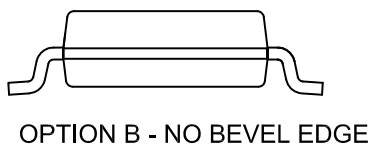
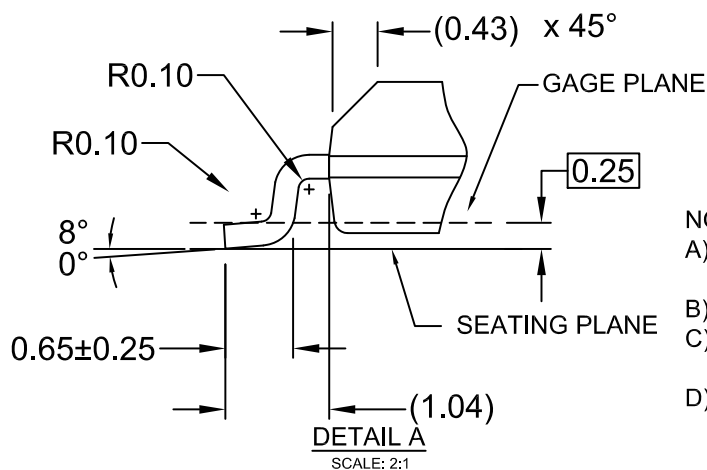
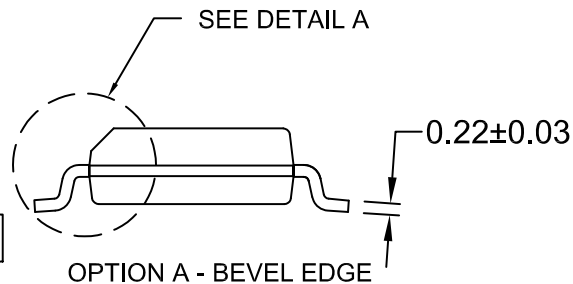
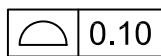
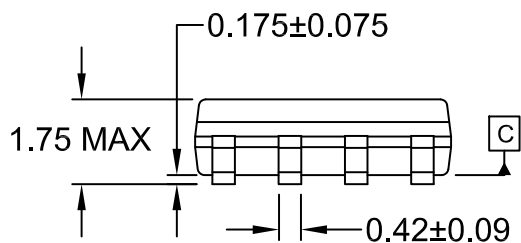
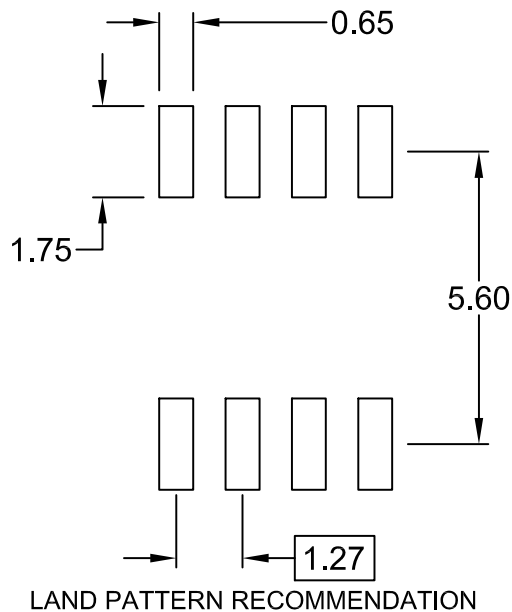
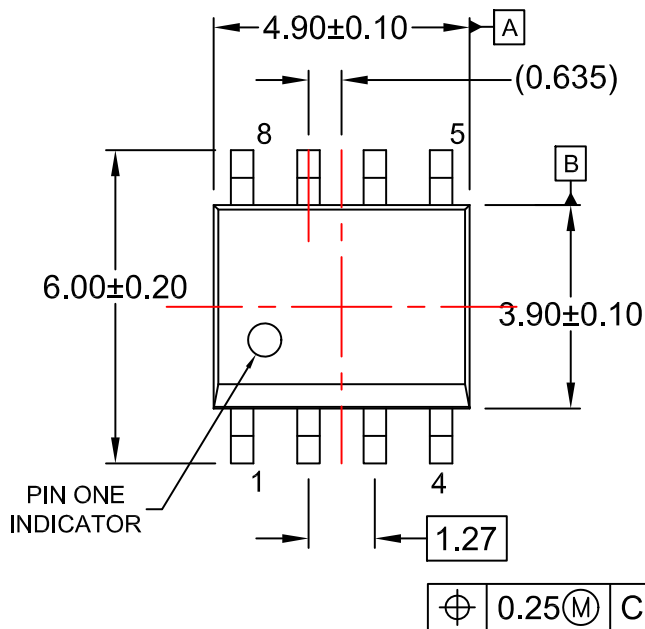

Figure 61. Maximum vs. Negative Offset Voltage vs. Temperature ($V_{CC} = V_{BS} = 15\text{ V}$)

SOIC8
CASE 751EB
ISSUE A

DATE 24 AUG 2017



- NOTES:
 A) THIS PACKAGE CONFORMS TO JEDEC MS-012, VARIATION AA.
 B) ALL DIMENSIONS ARE IN MILLIMETERS.
 C) DIMENSIONS DO NOT INCLUDE MOLD FLASH OR BURRS.
 D) LANDPATTERN STANDARD: SOIC127P600X175-8M

DOCUMENT NUMBER:	98AON13735G	Electronic versions are uncontrolled except when accessed directly from the Document Repository. Printed versions are uncontrolled except when stamped "CONTROLLED COPY" in red.
DESCRIPTION:	SOIC8	PAGE 1 OF 1

onsemi and ONSEMI are trademarks of Semiconductor Components Industries, LLC dba onsemi or its subsidiaries in the United States and/or other countries. onsemi reserves the right to make changes without further notice to any products herein. onsemi makes no warranty, representation or guarantee regarding the suitability of its products for any particular purpose, nor does onsemi assume any liability arising out of the application or use of any product or circuit, and specifically disclaims any and all liability, including without limitation special, consequential or incidental damages. onsemi does not convey any license under its patent rights nor the rights of others.

onsemi, **Onsemi**, and other names, marks, and brands are registered and/or common law trademarks of Semiconductor Components Industries, LLC dba "**onsemi**" or its affiliates and/or subsidiaries in the United States and/or other countries. **onsemi** owns the rights to a number of patents, trademarks, copyrights, trade secrets, and other intellectual property. A listing of **onsemi**'s product/patent coverage may be accessed at www.onsemi.com/site/pdf/Patent-Marking.pdf. **onsemi** reserves the right to make changes at any time to any products or information herein, without notice. The information herein is provided "as-is" and **onsemi** makes no warranty, representation or guarantee regarding the accuracy of the information, product features, availability, functionality, or suitability of its products for any particular purpose, nor does **onsemi** assume any liability arising out of the application or use of any product or circuit, and specifically disclaims any and all liability, including without limitation special, consequential or incidental damages. Buyer is responsible for its products and applications using **onsemi** products, including compliance with all laws, regulations and safety requirements or standards, regardless of any support or applications information provided by **onsemi**. "Typical" parameters which may be provided in **onsemi** data sheets and/or specifications can and do vary in different applications and actual performance may vary over time. All operating parameters, including "Typicals" must be validated for each customer application by customer's technical experts. **onsemi** does not convey any license under any of its intellectual property rights nor the rights of others. **onsemi** products are not designed, intended, or authorized for use as a critical component in life support systems or any FDA Class 3 medical devices or medical devices with a same or similar classification in a foreign jurisdiction or any devices intended for implantation in the human body. Should Buyer purchase or use **onsemi** products for any such unintended or unauthorized application, Buyer shall indemnify and hold **onsemi** and its officers, employees, subsidiaries, affiliates, and distributors harmless against all claims, costs, damages, and expenses, and reasonable attorney fees arising out of, directly or indirectly, any claim of personal injury or death associated with such unintended or unauthorized use, even if such claim alleges that **onsemi** was negligent regarding the design or manufacture of the part. **onsemi** is an Equal Opportunity/Affirmative Action Employer. This literature is subject to all applicable copyright laws and is not for resale in any manner.

ADDITIONAL INFORMATION

TECHNICAL PUBLICATIONS:

Technical Library: www.onsemi.com/design/resources/technical-documentation
onsemi Website: www.onsemi.com

ONLINE SUPPORT: www.onsemi.com/support

For additional information, please contact your local Sales Representative at www.onsemi.com/support/sales