

FAN4860

Table 1. ORDERING INFORMATION

Part Number	Operating Temperature Range	Package	Packing Method
FAN4860UC5X	-40°C to 85°C	WLCSP, 0.4 mm Pitch	Tape and Reel
FAN4860UMP5X	-40°C to 85°C	UMLP-6, 2 x 2 mm	Tape and Reel
FAN4860UC33X*	-40°C to 85°C	WLCSP, 0.4 mm Pitch	Tape and Reel
FAN4860UC54X*	-40°C to 85°C	WLCSP, 0.4 mm Pitch	Tape and Reel

*This device is End of Life. Please contact sales for additional information and assistance with replacement devices.

BLOCK DIAGRAMS

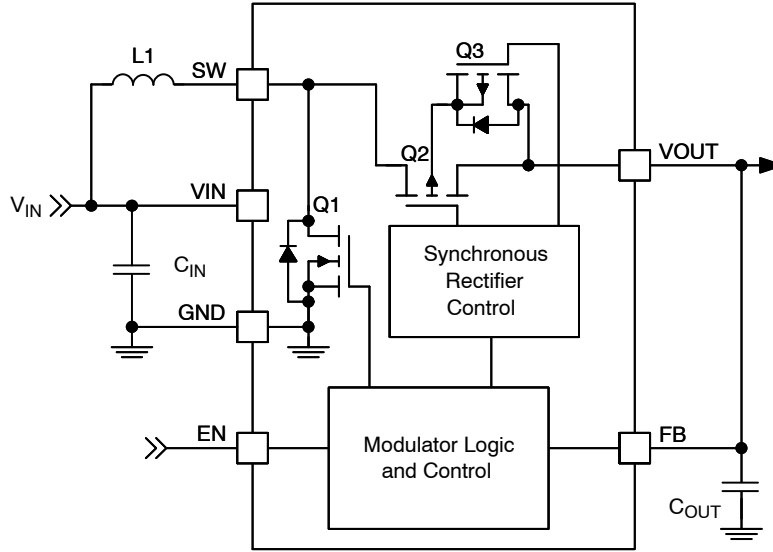

Figure 1. IC Block Diagram

PIN CONFIGURATIONS

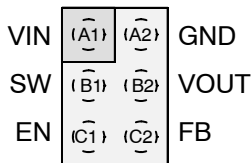

Figure 2. WLCSP (Top View)

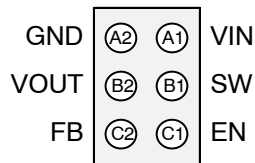

Figure 3. WLCSP (Bottom View)

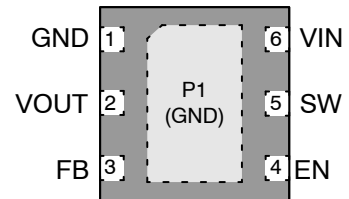

Figure 4. 2x2 mm UMLP (Top View)

FAN4860

Table 2. PIN DEFINITIONS

Pin #		Name	Description
WLCSP	UMLP		
A1	6	VIN	Input Voltage. Connect to Li-Ion battery input power source and input capacitor (C _{IN})
B1	5	SW	Switching Node. Connect to inductor
C1	4	EN	Enable. When this pin is HIGH, the circuit is enabled. This pin should not be left floating
C2	3	FB	Feedback. Output voltage sense point for V _{OUT} . Connect to output capacitor (C _{OUT})
B2	2	VOUT	Output Voltage. This pin is both the output voltage terminal as well as an IC bias supply
A2	1, P1	GND	Ground. Power and signal ground reference for the IC. All voltages are measured with respect to this pin

Table 3. ABSOLUTE MAXIMUM RATINGS

Symbol	Parameter		Min.	Max.	Units
V _{IN}	VIN Pin		-0.3	5.5	V
V _{OUT}	VOUT Pin		-2	6	V
V _{FB}	FB Pin		-2	6	V
V _{SW}	SW Node	DC	-0.3	5.5	V
		Transient: 10 ns, 3 MHz	-1.0	6.5	
V _{EN}	EN Pin		-0.3	5.5	V
ESD	Electrostatic Discharge Protection Level	Human Body Model per JESD22-A114	2		kV
		Charged Device Model per JESD22-C101	1		
T _J	Junction Temperature		-40	+150	°C
T _{STG}	Storage Temperature		-65	+150	°C
T _L	Lead Soldering Temperature, 10 Seconds			+260	°C

Stresses exceeding those listed in the Maximum Ratings table may damage the device. If any of these limits are exceeded, device functionality should not be assumed, damage may occur and reliability may be affected.

Table 4. RECOMMENDED OPERATING CONDITIONS

Symbol	Parameter		Min.	Max.	Units
V _{IN}	Supply Voltage	5.4 V _{OUT}	2.3	4.5	V
		5.0 V _{OUT}	2.3	4.5	
		3.3 V _{OUT}	2.5	3.2	
I _{OUT}	Output Current			200	mA
T _A	Ambient Temperature		-40	+85	°C
T _J	Junction Temperature		-40	+125	°C

Functional operation above the stresses listed in the Recommended Operating Ranges is not implied. Extended exposure to stresses beyond the Recommended Operating Ranges limits may affect device reliability.

FAN4860

Table 5. THERMAL PROPERTIES

Symbol	Parameter	Typical	Units
θ_{JA}	Junction-to-Ambient Thermal Resistance	WLCSP	130
		UMLP	57

1. Junction-to-ambient thermal resistance is a function of application and board layout. This data is measured with four-layer 2s2p boards in accordance to JEDEC standard JESD51. Special attention must be paid not to exceed junction temperature $T_{J(max)}$ at a given ambient temperature T_A .

Table 6. ELECTRICAL SPECIFICATIONS

(Minimum and maximum values are at $V_{IN} = V_{EN} = 2.3\text{ V}$ to 4.5 V (2.5 to 3.2 V_{IN} for 3.3 V_{OUT} option), $T_A = -40^\circ\text{C}$ to $+85^\circ\text{C}$; circuit of Typical Application, unless otherwise noted. Typical values are at $T_A = 25^\circ\text{C}$, $V_{IN} = V_{EN} = 3.6\text{ V}$ for $V_{OUT} = 5.0\text{ V} / 5.4\text{ V}$, and $V_{IN} = V_{EN} = 2.7\text{ V}$ for $V_{OUT} = 3.3\text{ V}$)

Symbol	Parameter	Conditions	Min	Typ	Max	Units	
I_{IN}	V_{IN} Input Current	5.4 V_{OUT}	Quiescent: $V_{IN} = 3.6\text{ V}$, $I_{OUT} = 0$, $EN = V_{IN}$		37	45	μA
			Shutdown: $EN = 0$, $V_{IN} = 3.6\text{ V}$		0.5	1.5	μA
		5.0 V_{OUT}	Quiescent: $V_{IN} = 3.6\text{ V}$, $I_{OUT} = 0$, $EN = V_{IN}$		37	45	
			Shutdown: $EN = 0$, $V_{IN} = 3.6\text{ V}$		0.5	1.5	
		3.3 V_{OUT}	Quiescent: $V_{IN} = 2.7\text{ V}$, $I_{OUT} = 0$, $EN = V_{IN}$		50	65	
			Shutdown: $EN = 0$, $V_{IN} = 2.7\text{ V}$		0.5	1.5	
I_{LK_OUT}	V_{OUT} Leakage Current	$V_{OUT} = 0$, $EN = 0$, $V_{IN} \geq 3\text{ V}$		10		nA	
I_{LK_RVSR}	V_{OUT} to V_{IN} Reverse Leakage	$V_{OUT} = 5.4\text{ V}$, $V_{IN} = 3.6\text{ V}$, $EN = 0$			2.5	μA	
		$V_{OUT} = 5.0\text{ V}$, $V_{IN} = 3.6\text{ V}$, $EN = 0$					
		$V_{OUT} = 3.3\text{ V}$, $V_{IN} = 3.0\text{ V}$, $EN = 0$					
V_{UVLO}	Under-Voltage Lockout	V_{IN} Rising		2.2	2.3	V	
V_{UVLO_HYS}	Under-Voltage Lockout Hysteresis			190		mV	
V_{ENH}	Enable HIGH Voltage		1.05			V	
V_{ENL}	Enable LOW Voltage				0.4	V	
I_{LK_EN}	Enable Input Leakage Current			0.01	1.00	μA	
V_{OUT}	Output Voltage Accuracy (Note 2)	V_{IN} from 2.3 V to 4.5 V, $I_{OUT} \leq 200\text{ mA}$	5.15	5.40	5.50	V	
		V_{IN} from 2.7 V to 4.5 V, $I_{OUT} \leq 200\text{ mA}$	5.20	5.40	5.50		
		V_{IN} from 3.3 V to 4.5 V, $I_{OUT} \leq 300\text{ mA}$	5.15	5.40	5.50		
		V_{IN} from 2.3 V to 4.5 V, $I_{OUT} \leq 200\text{ mA}$	4.80	5.05	5.15		
		V_{IN} from 2.7 V to 4.5 V, $I_{OUT} \leq 200\text{ mA}$	4.85	5.05	5.15		
		V_{IN} from 3.3 V to 4.5 V, $I_{OUT} \leq 300\text{ mA}$	4.85	5.05	5.15		
		V_{IN} from 2.5 V to 3.2 V, $I_{OUT} \leq 200\text{ mA}$	3.17	3.33	3.41		
V_{ref}	Reference Accuracy	Referred to $V_{OUT} = 5.4\text{ V}$	5.325	5.400	5.475	V	
		Referred to $V_{OUT} = 5.0\text{ V}$	4.975	5.050	5.125		
		Referred to $V_{OUT} = 3.3\text{ V}$	3.280	3.330	3.380		
t_{OFF}	Off Time	$V_{IN} = 3.6\text{ V}$, $V_{OUT} = 5.4\text{ V}$, $I_{OUT} = 200\text{ mA}$	185	230	255	ns	
		$V_{IN} = 3.6\text{ V}$, $V_{OUT} = 5.0\text{ V}$, $I_{OUT} = 200\text{ mA}$	195	240	265		
		$V_{IN} = 2.7\text{ V}$, $V_{OUT} = 3.3\text{ V}$, $I_{OUT} = 200\text{ mA}$	240	290	350		

FAN4860

Table 6. ELECTRICAL SPECIFICATIONS (continued)

(Minimum and maximum values are at $V_{IN} = V_{EN} = 2.3\text{ V}$ to 4.5 V (2.5 to 3.2 V_{IN} for 3.3 V_{OUT} option), $T_A = -40^\circ\text{C}$ to $+85^\circ\text{C}$; circuit of Typical Application, unless otherwise noted. Typical values are at $T_A = 25^\circ\text{C}$, $V_{IN} = V_{EN} = 3.6\text{ V}$ for $V_{OUT} = 5.0\text{ V} / 5.4\text{ V}$, and $V_{IN} = V_{EN} = 2.7\text{ V}$ for $V_{OUT} = 3.3\text{ V}$)

Symbol	Parameter	Conditions	Min	Typ	Max	Units	
I_{OUT}	Maximum Output Current (Note 2)	5.4 V_{OUT}	$V_{IN} = 2.3\text{ V}$	200			mA
			$V_{IN} = 3.3\text{ V}$	300			
			$V_{IN} = 3.6\text{ V}$		400		
		5.0 V_{OUT}	$V_{IN} = 2.3\text{ V}$	200			
			$V_{IN} = 3.3\text{ V}$	300			
			$V_{IN} = 3.6\text{ V}$		400		
		3.3 V_{OUT}	$V_{IN} = 2.5\text{ V}$	250			
$V_{IN} = 2.7\text{ V}$			300				
I_{SW}		SW Peak Current Limit	5.4 V_{OUT}	$V_{IN} = 3.6\text{ V}, V_{OUT} > V_{IN}$	1000	1400	
	5.0 V_{OUT}		$V_{IN} = 3.6\text{ V}, V_{OUT} > V_{IN}$	930	1100	1320	
	3.3 V_{OUT}		$V_{IN} = 2.7\text{ V}, V_{OUT} > V_{IN}$	650	800	950	
I_{SS}	Soft-Start Input Peak Current Limit (Note 3)	5.4 V_{OUT}	$V_{IN} = 3.6\text{ V}, V_{OUT} < V_{IN}$		900		mA
		5.0 V_{OUT}	$V_{IN} = 3.6\text{ V}, V_{OUT} < V_{IN}$		850		
		3.3 V_{OUT}	$V_{IN} = 2.7\text{ V}, V_{OUT} < V_{IN}$		700		
t_{SS}	Soft-Start Time (Note 4)	5.4 V_{OUT}	$V_{IN} = 3.6\text{ V}, I_{OUT} = 200\text{ mA}$		270	400	μs
		5.0 V_{OUT}	$V_{IN} = 3.6\text{ V}, I_{OUT} = 200\text{ mA}$		100	300	
		3.3 V_{OUT}	$V_{IN} = 2.7\text{ V}, I_{OUT} = 200\text{ mA}$		250	750	
$R_{DS(ON)}$	N-Channel Boost Switch	$V_{IN} = 3.6\text{ V}$		300		m Ω	
	P-Channel Sync Rectifier	$V_{IN} = 3.6\text{ V}$		400			
T_{TSD}	Thermal Shutdown	$I_{LOAD} = 10\text{ mA}$		150		$^\circ\text{C}$	
T_{TSD_HYS}	Thermal Shutdown Hysteresis			30		$^\circ\text{C}$	

- I_{LOAD} from 0 to I_{OUT} ; also includes load transient response. V_{OUT} measured from mid-point of output voltage ripple. Effective capacitance of $C_{OUT} > 1.5\text{ }\mu\text{F}$.
- Guaranteed by design and characterization; not tested in production.
- Elapsed time from rising EN until regulated V_{OUT} .

5.4 V_{OUT} TYPICAL CHARACTERISTICS

Unless otherwise specified; circuit per Typical Application, 3.6 V_{IN}, and T_A = 25°C.

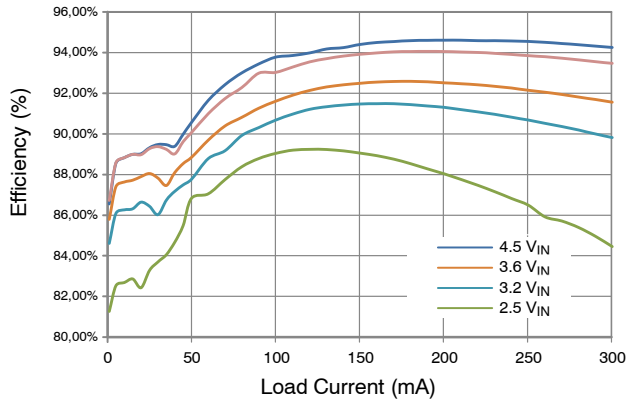

Figure 5. Efficiency vs. V_{IN}

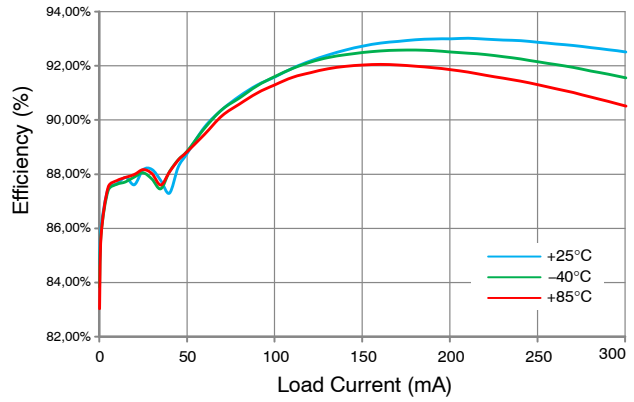

Figure 6. Efficiency vs. Temperature, 3.6 V_{IN}

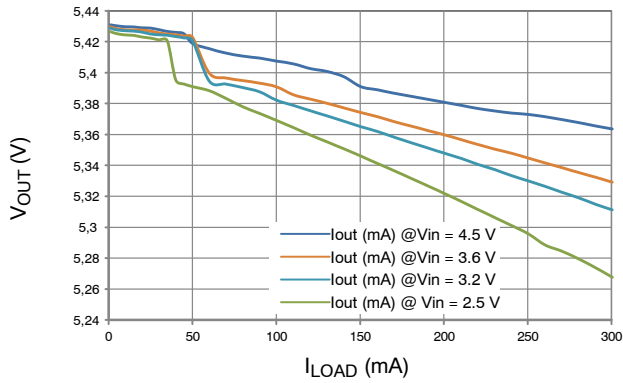

Figure 7. Line and Load Regulation

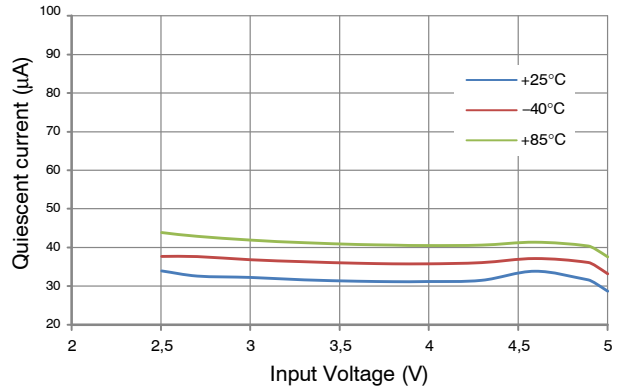

Figure 8. Quiescent Current

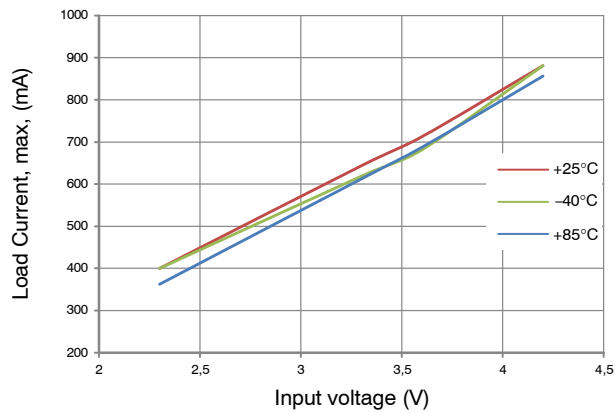

Figure 9. Maximum DC Load Current

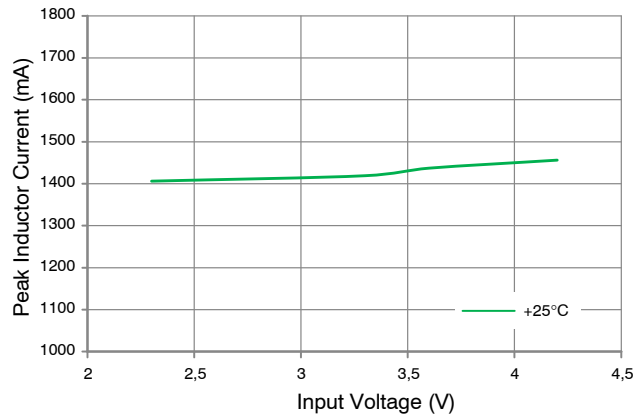

Figure 10. Peak Inductor Current

5.4 V_{OUT} TYPICAL CHARACTERISTICS (continued)

Unless otherwise specified; circuit per Typical Application, 3.6 V_{IN}, and T_A=25°C.

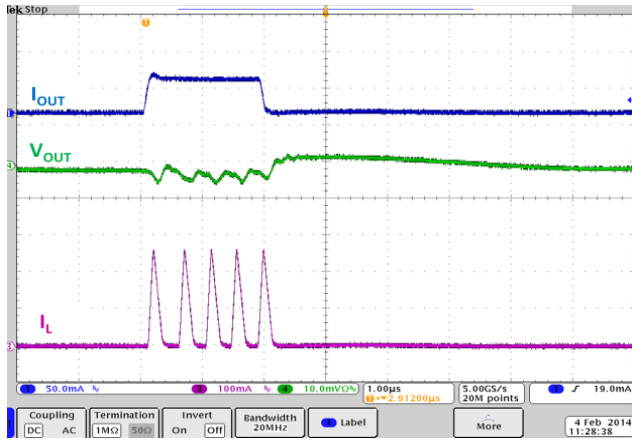

Figure 11. 0–50 mA Load Transient, 100 ns Step

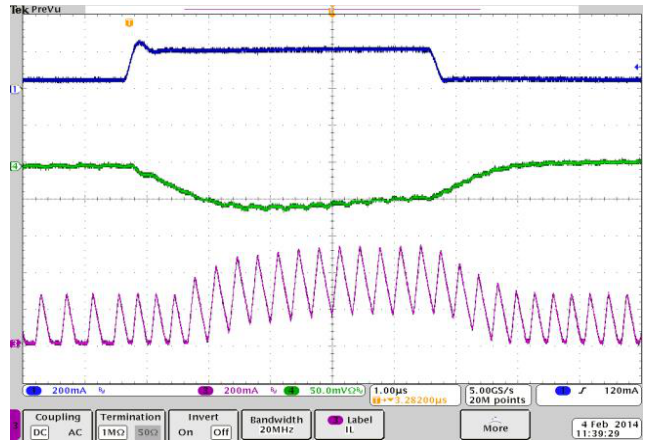

Figure 12. 50–200 mA Load Transient, 100 ns Step

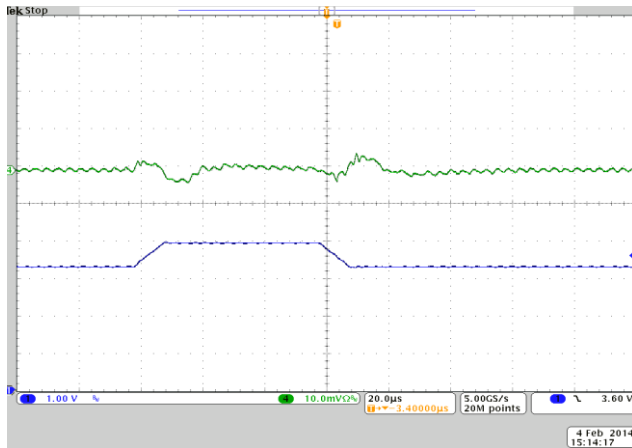

Figure 13. Line Transient, 5 mA Load, 10 µs Step



Figure 14. Line Transient, 200 mA Load, 10 µs Step

5.0 V_{OUT} TYPICAL CHARACTERISTICS

Unless otherwise specified; circuit per Typical Application, 3.6 V_{IN}, and T_A = 25°C.

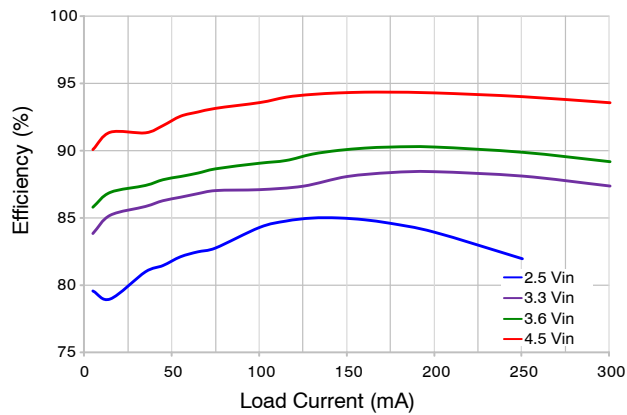

Figure 15. Efficiency vs. V_{IN}

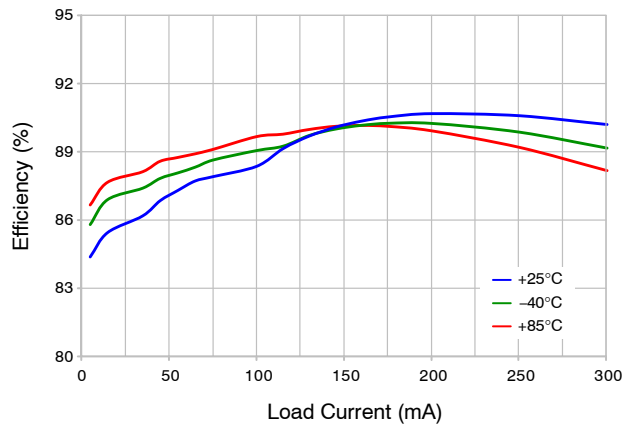

Figure 16. Efficiency vs. Temperature, 3.6 V_{IN}

5.0 V_{OUT} TYPICAL CHARACTERISTICS (continued)

Unless otherwise specified; circuit per Typical Application, 3.6 V_{IN} , and $T_A = 25^\circ C$.

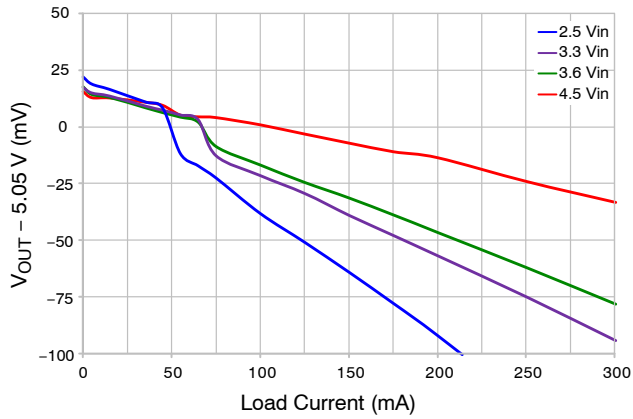

Figure 17. Line and Load Regulation

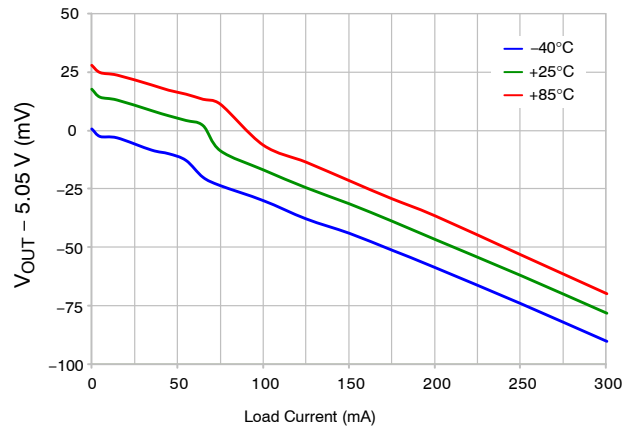

Figure 18. Load Regulation vs. Temperature, 3.6 V_{IN}

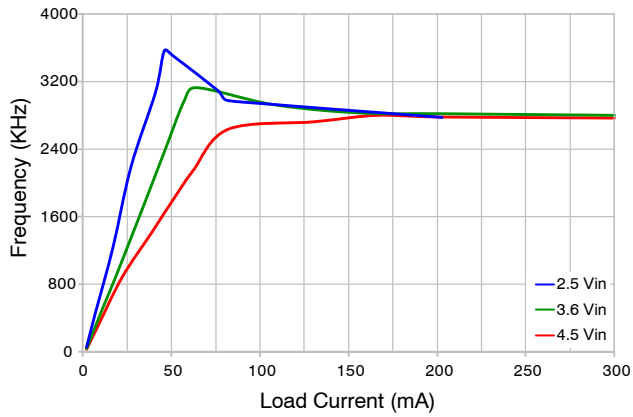

Figure 19. Switching Frequency

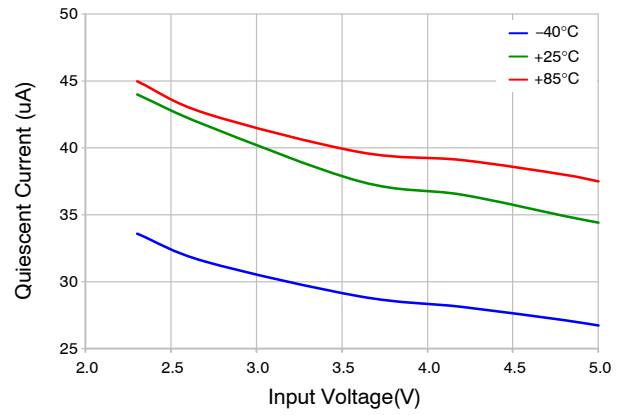

Figure 20. Quiescent Current

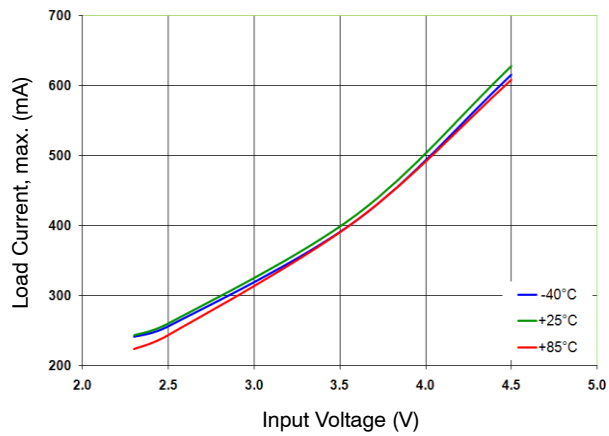

Figure 21. Maximum DC Load Current

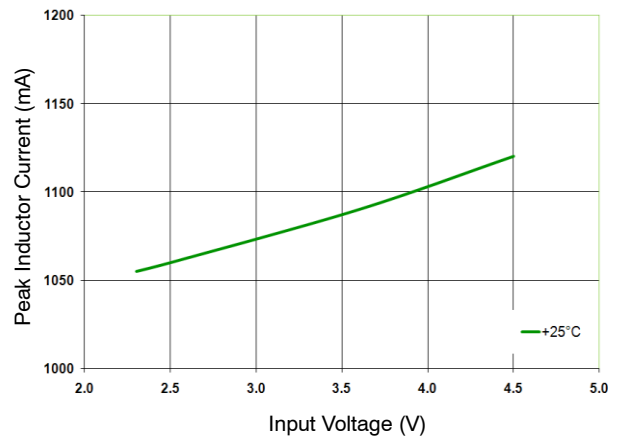

Figure 22. Peak Inductor Current

5.0 V_{OUT} TYPICAL CHARACTERISTICS (continued)

Unless otherwise specified; circuit per Typical Application, 3.6 V_{IN}, and T_A = 25°C.

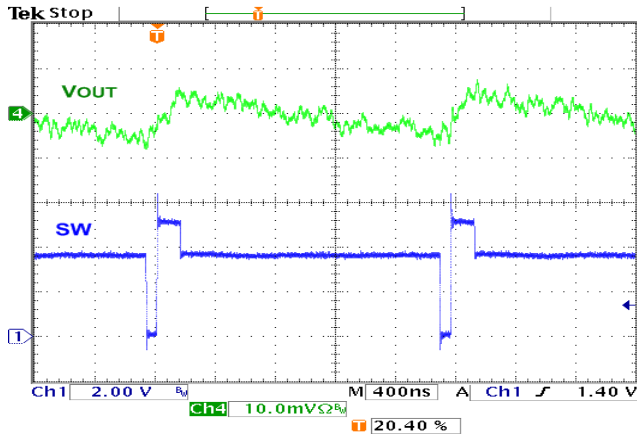

Figure 23. Output Ripple, 10 mA PFM Load

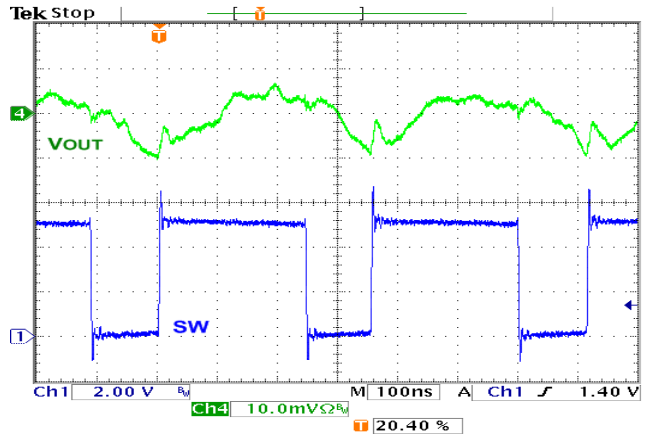

Figure 24. Output Ripple, 200 mA PWM Load

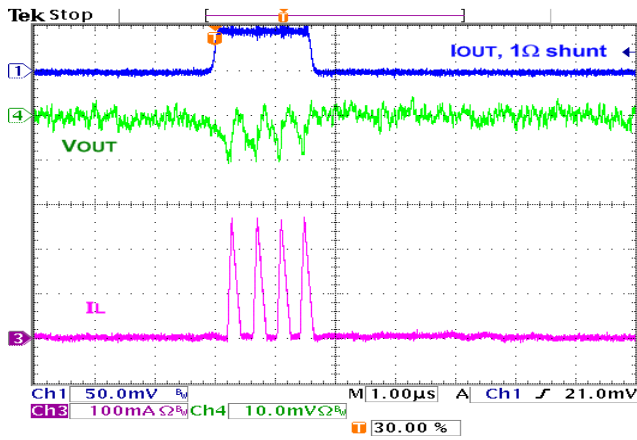

Figure 25. 0–50 mA Load Transient, 100 ns Step

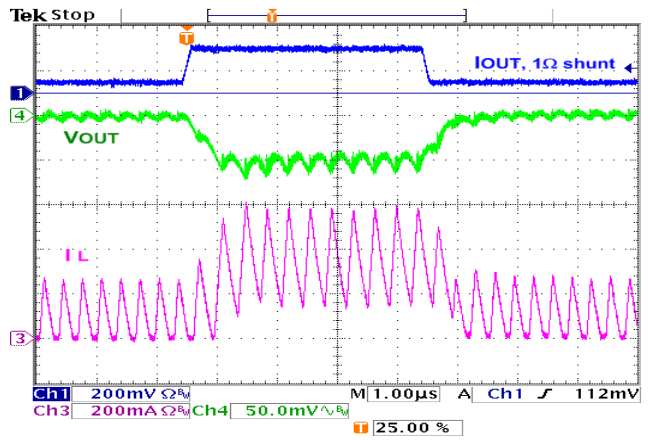

Figure 26. 50–200 mA Load Transient, 100 ns Step

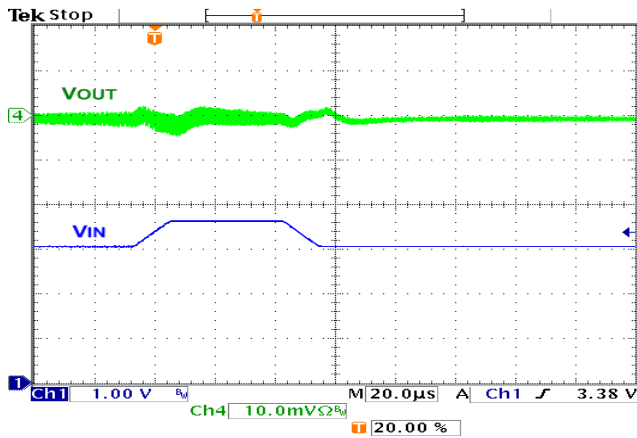

Figure 27. Line Transient, 5 mA Load, 10 μs Step

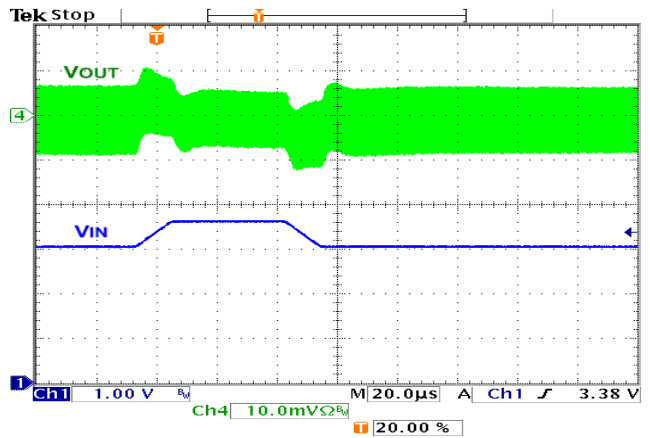

Figure 28. Line Transient, 200 mA Load, 10 μs Step

5.0 V_{OUT} TYPICAL CHARACTERISTICS (continued)

Unless otherwise specified; circuit per Typical Application, 3.6 V_{IN}, and T_A = 25°C.

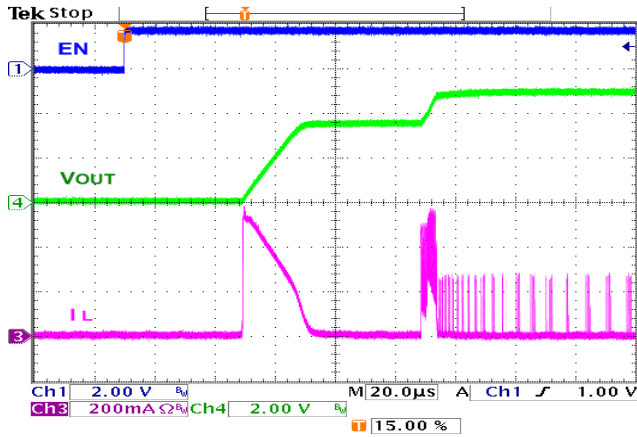

Figure 29. Start Up, No load

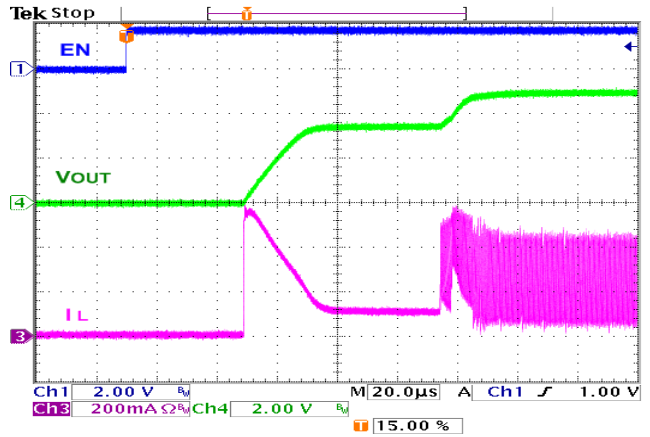

Figure 30. Start Up, 33 Ω Load

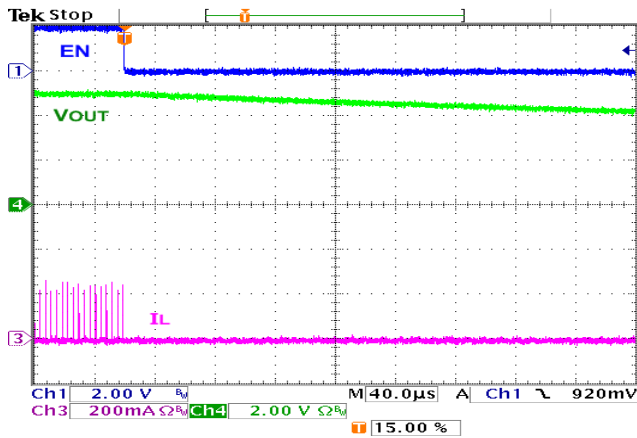

Figure 31. Shutdown, 1 kΩ Load

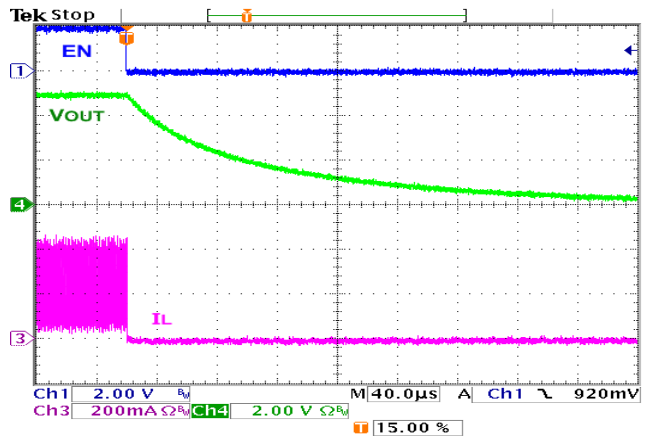

Figure 32. Shutdown, 33 Ω Load

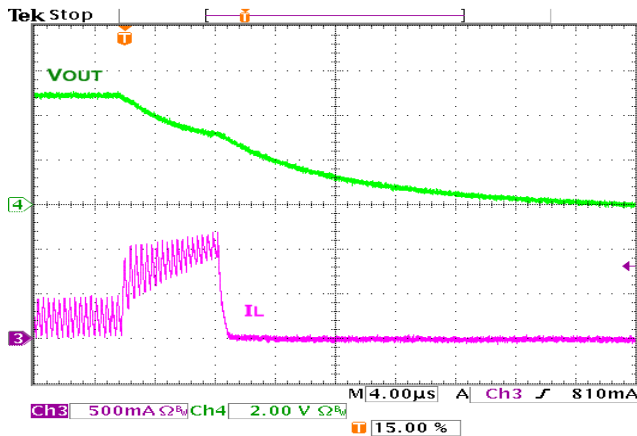

Figure 33. Overload Protection

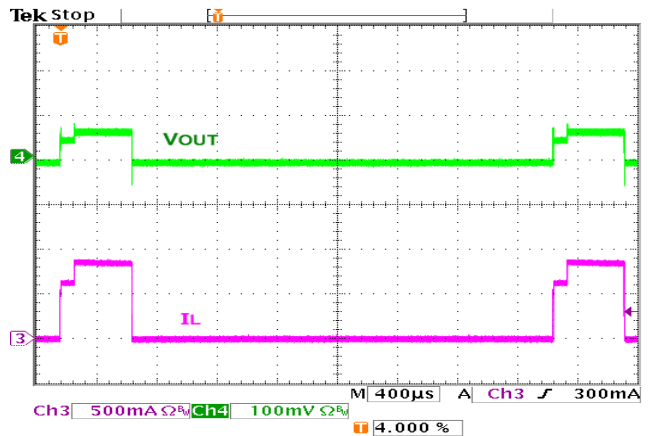

Figure 34. Short-Circuit Response

3.3 V_{OUT} TYPICAL CHARACTERISTICS

Unless otherwise specified; circuit per Typical Application, 3.0 V_{IN}, and T_A = 25°C.

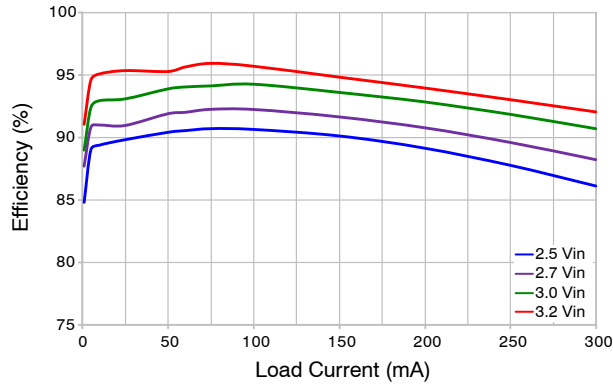

Figure 35. Efficiency vs. V_{IN}

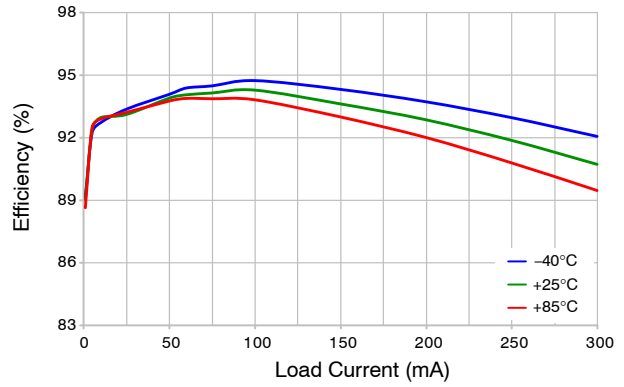

Figure 36. Efficiency vs. Temperature, 3.0 V_{IN}

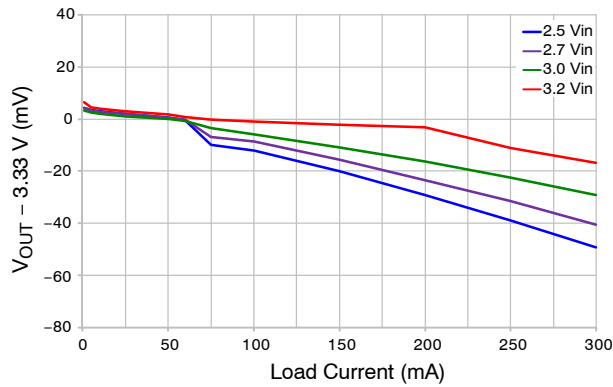

Figure 37. Line and Load Regulation

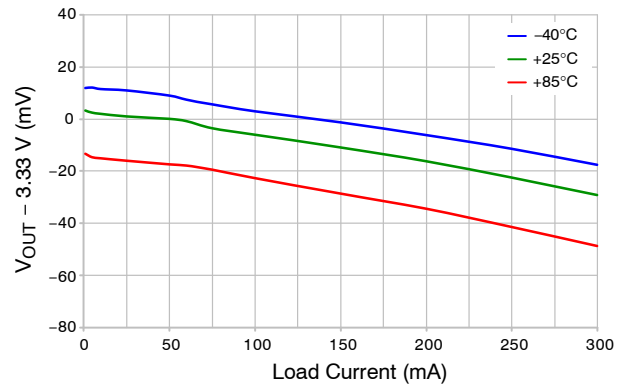

Figure 38. Load Regulation vs. Temperature, 3.0 V_{IN}

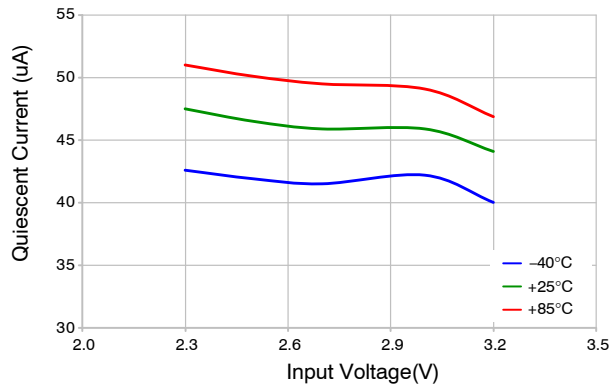

Figure 39. Quiescent Current

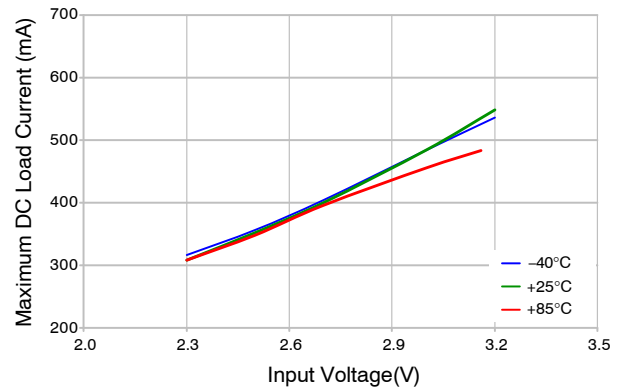

Figure 40. Maximum DC Load Current

3.3 V_{OUT} TYPICAL CHARACTERISTICS (continued)

Unless otherwise specified; circuit per Typical Application, 3.0 V_{IN}, and T_A = 25°C.

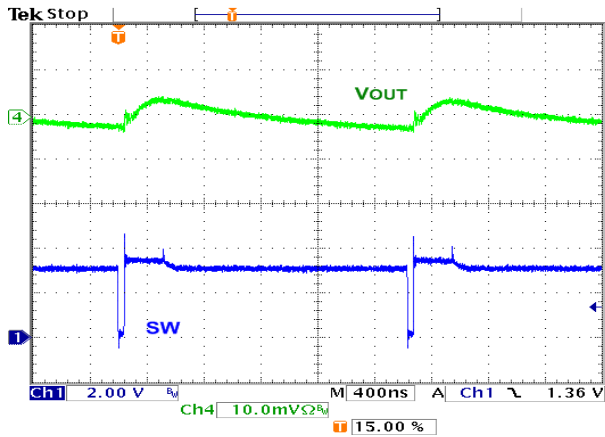

Figure 41. Output Ripple, 10 mA PFM Load

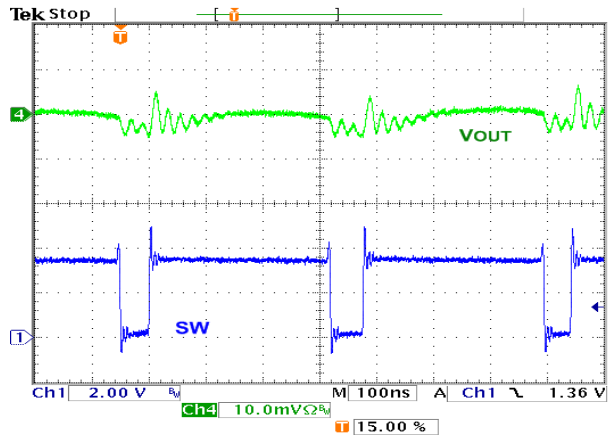

Figure 42. Output Ripple, 200 mA PWM Load

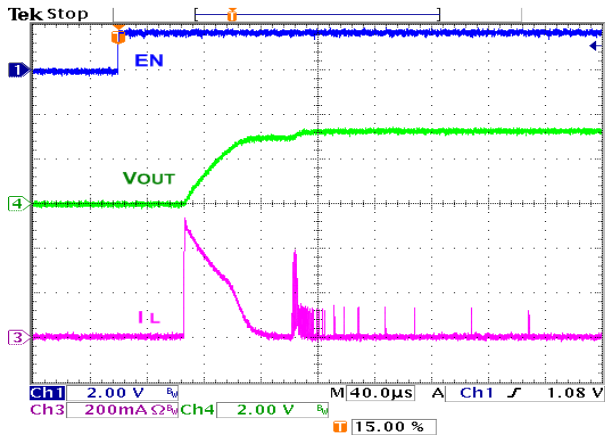

Figure 43. Startup, No Load

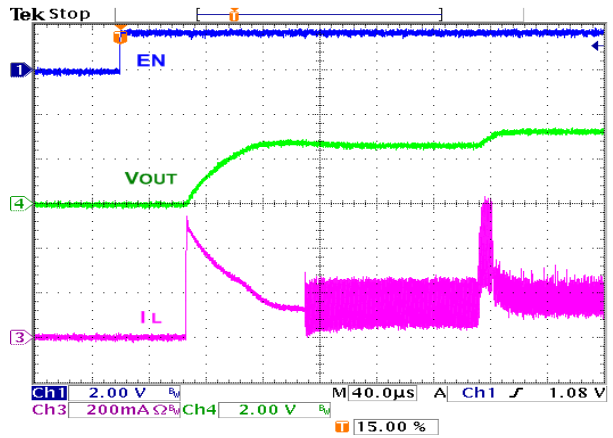

Figure 44. Startup, 22 Ω Load

FUNCTIONAL DESCRIPTION

Circuit Description

The FAN4860 is a synchronous boost regulator, typically operating at 3 MHz in Continuous Conduction Mode (CCM), which occurs at moderate to heavy load current and low V_{IN} voltages.

At light-load currents, the converter switches automatically to power-saving PFM Mode. The regulator automatically and smoothly transitions between quasi-fixed-frequency continuous conduction PWM Mode and variable-frequency PFM Mode to maintain the highest possible efficiency over the full range of load current and input voltage.

PWM Mode Regulation

The FAN4860 uses a minimum on-time and computed minimum off-time to regulate V_{OUT} . The regulator achieves excellent transient response by employing current mode modulation. This technique causes the regulator output to exhibit a load line. During PWM Mode, the output voltage drops slightly as the input current rises. With a constant V_{IN} , this appears as a constant output resistance.

The “droop” caused by the output resistance when a load is applied allows the regulator to respond smoothly to load transients with negligible overshoot.

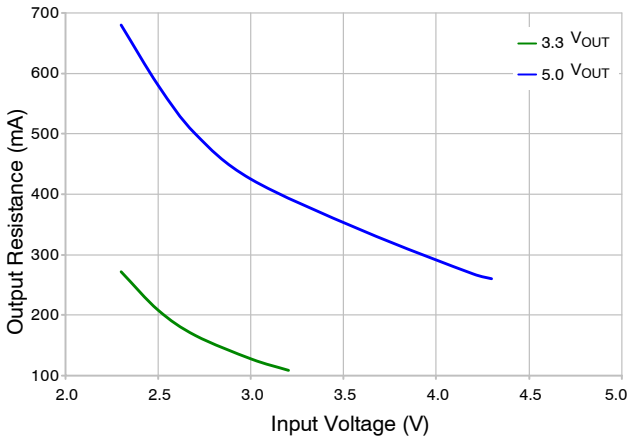

Figure 45. Output Resistance (R_{OUT})

When the regulator is in PWM CCM Mode and the target $V_{OUT} = 5.05$ V, V_{OUT} is a function of I_{LOAD} and can be computed as:

$$V_{OUT} = 5.05 - R_{OUT} \times I_{LOAD} \quad (\text{eq. 1})$$

For example, at $V_{IN} = 3.3$ V, and $I_{LOAD} = 200$ mA, V_{OUT} drops to:

$$V_{OUT} = 5.05 - 0.38 \times 0.2 = 4.974 \text{ V} \quad (\text{eq. 2})$$

At $V_{IN} = 2.3$ V, and $I_{LOAD} = 200$ mA, V_{OUT} drops to:

$$V_{OUT} = 5.05 - 0.68 \times 0.2 = 4.914 \text{ V} \quad (\text{eq. 3})$$

PFM Mode

If $V_{OUT} > V_{REF}$ when the minimum off-time has ended, the regulator enters PFM Mode. Boost pulses are inhibited until $V_{OUT} < V_{REF}$. The minimum on-time is increased to enable the output to pump up sufficiently with each PFM boost pulse. Therefore, the regulator behaves like a constant on-time regulator, with the bottom of its output voltage ripple at 5.05 V in PFM Mode.

Table 7. OPERATING STATES

Mode	Description	Invoked When:
LIN	Linear Startup	$V_{IN} > V_{OUT}$
SS	Boost Soft-Start	$V_{OUT} < V_{REG}$
BST	Boost Operating Mode	$V_{OUT} = V_{REG}$

Shutdown and Startup

If EN is LOW, all bias circuits are off and the regulator is in Shutdown Mode. During shutdown, true load disconnect between battery and load prevents current flow from V_{IN} to V_{OUT} , as well as reverse flow from V_{OUT} to V_{IN} .

LIN State

When EN rises, if $V_{IN} > UVLO$, the regulator first attempts to bring V_{OUT} within about 1V of V_{IN} by using the internal fixed current source from V_{IN} (I_{LIN1}). The current is limited to about 630 mA during LIN1 Mode.

If V_{OUT} reaches $V_{IN} - 1$ V during LIN1 Mode, the SS state is initiated. Otherwise, LIN1 times out after 16 clock counts and the LIN2 Mode is entered.

In LIN2 Mode, the current source is incremented to 850 mA. If V_{OUT} fails to reach $V_{IN} - 1$ V after 64 clock counts, a fault condition is declared.

SS State

Upon the successful completion of the LIN state ($V_{OUT} \geq V_{IN} - 1$ V), the regulator begins switching with boost pulses current limited to about 50% of nominal level, incrementing to full scale over a period of 32 clock counts.

If the output fails to achieve 90% of its set point within 96 clock counts at full-scale current limit, a fault condition is declared.

BST State

This is the normal operating mode of the regulator. The regulator uses a minimum t_{OFF} -minimum t_{ON} modulation scheme. Minimum t_{OFF} is proportional to V_{IN} / V_{OUT} , which keeps the regulator’s switching frequency reasonably constant in CCM. $t_{ON(MIN)}$ is proportional to V_{IN} and is higher if the inductor current reaches 0 before $t_{OFF(MIN)}$ during the prior cycle.

To ensure that V_{OUT} does not pump significantly above the regulation point, the boost switch remains off as long as $FB > V_{REF}$.

Fault State

The regulator enters the FAULT state under any of the following conditions:

- V_{OUT} fails to achieve the voltage required to advance from LIN state to SS state
- V_{OUT} fails to achieve the voltage required to advance from SS state to BST state
- Sustained (32 CLK counts) pulse-by-pulse current limit during the BST state
- The regulator moves from BST to LIN state due to a short circuit or output overload ($V_{OUT} < V_{IN}-1\text{ V}$)

Once a fault is triggered, the regulator stops switching and presents a high-impedance path between V_{IN} and V_{OUT} . After waiting 480 CLK counts, a restart is attempted.

Soft-Start and Fault Timing

The soft-start timing for each state, and the fault times, are determined by the fault clock, whose period is inversely proportional to V_{IN} . This allows the regulator more time to charge larger values of C_{OUT} when V_{IN} is lower. With higher V_{IN} , this also reduces power delivered to V_{OUT} during each cycle in current limit.

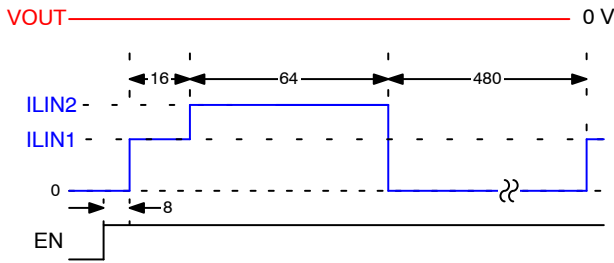

Figure 46. Fault Response into Short Circuit

The fault clock period as a function of V_{IN} is shown in Figure 47.

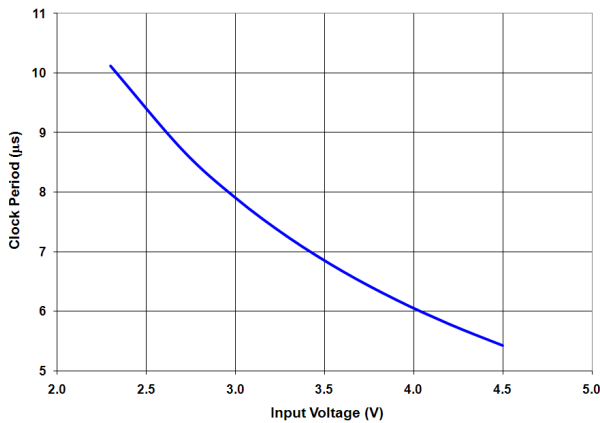

Figure 47. Fault Clock Period vs. V_{IN}

The V_{IN} -dependent LIN Mode charging current is illustrated in Figure 48.

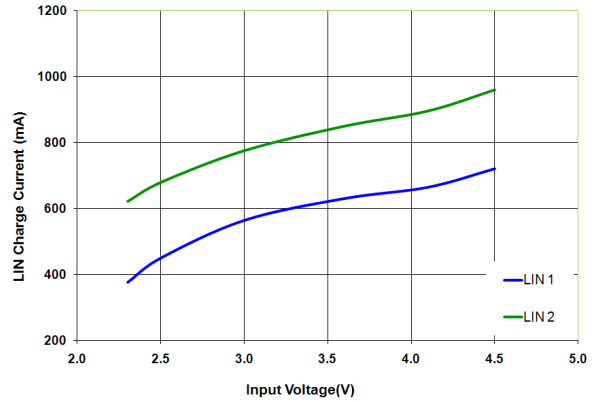

Figure 48. LIN Mode Current vs. V_{IN}

Over-Temperature Protection (OTP)

The regulator shuts down when the thermal shutdown threshold is reached. Restart, with soft-start, occurs when the IC has cooled by about 30°C.

Over-Current Protection (OCP)

During Boost Mode, the FAN4860 employs a cycle-by-cycle peak current limit to protect switching elements. Sustained current limit, for 32 consecutive fault clock counts, initiates a fault condition.

During an overload condition, as V_{OUT} collapses to approximately $V_{IN}-1\text{ V}$, the synchronous rectifier is immediately switched off and a fault condition is declared.

Automatic restart occurs once the overload/short is removed and the fault timer completes counting.

APPLICATION INFORMATION

External Component Selection

Table 8 shows the recommended external components for the FAN4860:

Table 8. EXTERNAL COMPONENTS

REF	Description	Manufacturer
L1	1.0 μH, 0.8 A, 190 mΩ, 0805	Murata LQM21PN1R0MC0, or equivalent
C _{IN}	2.2 μF, 6.3 V, X5R, 0402	Murata GRM155R60J225M
		TDK C1005X5R0J225M
C _{OUT}	4.7 μF, 10 V, X5R, 0603 (Note 5)	Kemet C0603C475K8PAC
		TDK C1608X5R1A475K

5. A 6.3 V-rated 0603 capacitor may be used for C_{OUT}, such as Murata GRM188R60J225M. All datasheet parameters are valid with the 6.3 V-rated capacitor. Due to DC bias effects, the 10 V capacitor offers a performance enhancement; particularly output ripple and transient response, without any size increase.

Output Capacitance (C_{OUT})

Stability

The effective capacitance (C_{EFF}) of small, high-value, ceramic capacitors decrease as their bias voltage increases, as shown in Figure 49.

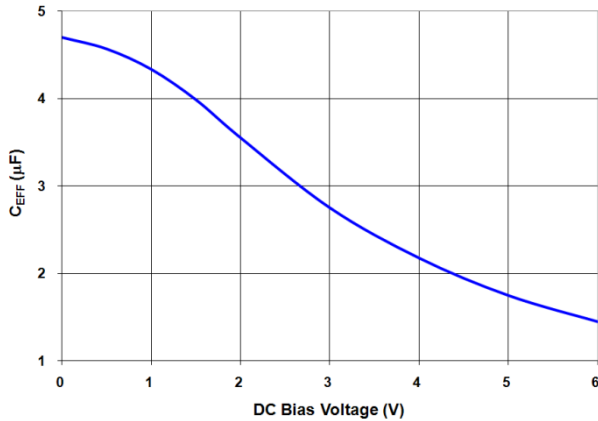

Figure 49. C_{EFF} for 4.7 μF, 0603, X5R, 6.3 V (Murata GRM188R60J475K)

FAN4860 is guaranteed for stable operation with the minimum value of C_{EFF} (C_{EFF(MIN)}) outlined in Table 9.

Table 9. MINIMUM C_{EFF} REQUIRED FOR STABILITY

Operating Conditions		C _{EFF(MIN)} (μF)
V _{IN} (V)	I _{LOAD} (mA)	
2.3 to 4.5	0 to 200	1.5
2.7 to 4.5	0 to 200	1.0
2.3 to 4.5	0 to 150	1.0

C_{EFF} varies with manufacturer, dielectric material, case size, and temperature. Some manufacturers may be able to provide an X5R capacitor in 0402 case size that retains C_{EFF} > 1.5 μF with 5 V bias; others may not. If this C_{EFF} cannot be economically obtained and 0402 case size is required, the IC can work with the 0402 capacitor as long as the minimum V_{IN} is restricted to > 2.7 V.

For best performance, a 10 V-rated 0603 output capacitor is recommended (Kemet C0603C475K8PAC, or equivalent). Since it retains greater C_{EFF} under bias and over temperature, output ripple can be reduced and transient capability enhanced.

Output Voltage Ripple

Output voltage ripple is inversely proportional to C_{OUT}. During t_{ON}, when the boost switch is on, all load current is supplied by C_{OUT}.

$$V_{\text{RIPPLE(P-P)}} = t_{\text{ON}} \times \frac{I_{\text{LOAD}}}{C_{\text{OUT}}} \quad (\text{eq. 4})$$

and

$$t_{\text{ON}} = t_{\text{SW}} \times D = t_{\text{SW}} \times \left(1 - \frac{V_{\text{IN}}}{V_{\text{OUT}}}\right) \quad (\text{eq. 5})$$

Therefore:

$$V_{\text{RIPPLE(P-P)}} = t_{\text{SW}} \times \left(1 - \frac{V_{\text{IN}}}{V_{\text{OUT}}}\right) \times \frac{I_{\text{LOAD}}}{C_{\text{OUT}}} \quad (\text{eq. 6})$$

Where:

$$t_{\text{SW}} = \frac{1}{f_{\text{SW}}} \quad (\text{eq. 7})$$

As can be seen from Equation 6, the maximum V_{RI}PPLE occurs when V_{IN} is minimum and I_{LOAD} is maximum.

Startup

Input current limiting is in effect during soft-start, which limits the current available to charge C_{OUT}. If the output fails to achieve regulation within the time period described in the soft-start section above; a FAULT occurs, causing the circuit to shut down, then restart after a significant time period. If C_{OUT} is a very high value, the circuit may not start on the first attempt, but eventually achieves regulation if no load is present. If a high-current load and high capacitance are both present during soft-start, the circuit may fail to achieve regulation and continually attempt soft-start, only to have C_{OUT} discharged by the load when in the FAULT state.

The circuit can start with higher values of C_{OUT} under full load if V_{IN} is higher, since:

$$I_{\text{OUT}} = \left(I_{\text{LIM(PK)}} - \frac{I_{\text{RIPPLE}}}{2}\right) \times \frac{V_{\text{IN}}}{V_{\text{OUT}}} \quad (\text{eq. 8})$$

Generally, the limitation occurs in BST Mode.

The FAN4860 starts on the first pass (without triggering a FAULT) under the following conditions for $C_{EFF(MAX)}$:

Table 10. MAXIMUM C_{EFF} FOR FIRST-PASS STARTUP

Operating Conditions				$C_{EFF(MAX)}$ (μF)
V_{IN} (V)	$R_{LOAD(MIN)}$ (Ω)			
	5.4 V_{OUT}	5.0 V_{OUT}	3.3 V_{OUT}	
> 2.3	27	25	16	10
> 2.7	27	25	16	15
> 2.7	37	33	20	22

C_{EFF} values shown in Table 10 typically apply to the lowest V_{IN} . The presence of higher V_{IN} enhances ability to start into larger C_{EFF} at full load.

Transient Protection

To protect against external voltage transients caused by ESD discharge events, or improper external connections, some applications employ an external transient voltage suppressor (TVS) and Schottky diode (D1 in Figure 50).

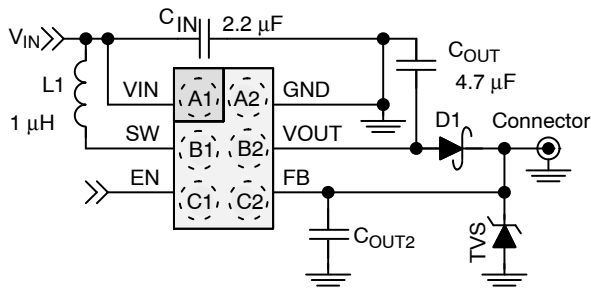

Figure 50. FAN4860 with External Transient Protection

The TVS is designed to clamp the FB line (system V_{OUT}) to +10 V or -2 V during external transient events. The Schottky diode protects the output devices from the positive excursion. The FB pin can tolerate up to 14 V of positive excursion, while both the FB and V_{OUT} pins can tolerate negative voltages.

The FAN4860 includes a circuit to detect a missing or defective D1 by comparing V_{OUT} to FB. If $V_{OUT} - FB >$ about 0.7 V, the IC shuts down. The IC remains shut down until $V_{OUT} < UVLO$ and $V_{IN} < UVLO + 0.7$ or EN is toggled.

C_{OUT2} may be necessary to preserve load transient response when the Schottky is used. When a load is applied

at the FB pin, the forward voltage of the D1 rapidly increases before the regulator can respond or the inductor current can change. This causes an immediate drop of up to 300 mV, depending on D1’s characteristics if C_{OUT2} is absent. C_{OUT2} supplies instantaneous current to the load while the regulator adjusts the inductor current. A value of at least half of the minimum value of C_{OUT} should be used for C_{OUT2} . C_{OUT2} needs to withstand the maximum voltage at the FB pin as the TVS is clamping.

The maximum DC output current available is reduced with this circuit, due to the additional dissipation of D1.

LAYOUT GUIDELINE

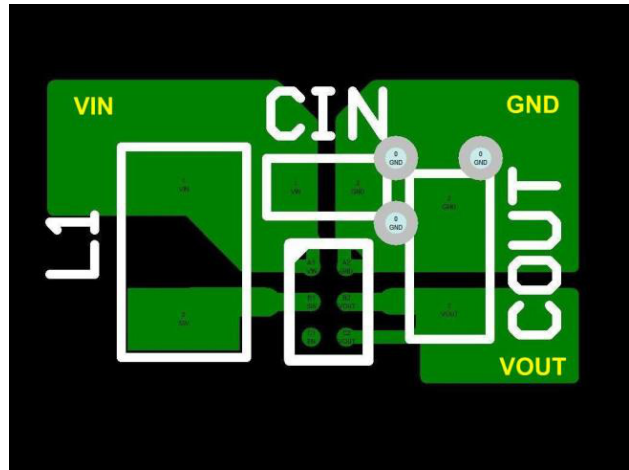

Figure 51. WLCSP Suggested Layout (Top View)

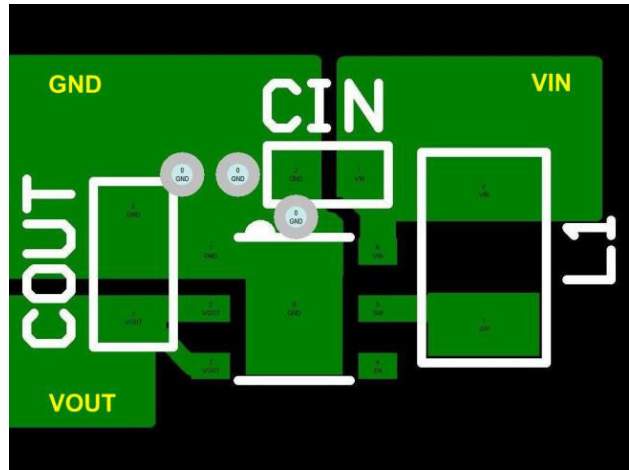

Figure 52. UMLP Suggested Layout (Top View)

PRODUCT-SPECIFIC DIMENSIONS

Product	D	E	X	Y
FAN4860UC5X	1.230mm ±0.030 mm	0.880 mm ±0.030 mm	0.240 mm	0.215 mm
FAN4860UC33X				

TINYBOOST is registered trademarks of Semiconductor Components Industries, LLC (SCILLC) or its subsidiaries in the United States and/or other countries.

WLCSP6 1.23x0.88x0.586
CASE 567RP
ISSUE O

DATE 30 NOV 2016

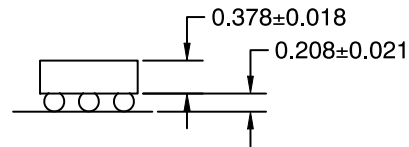
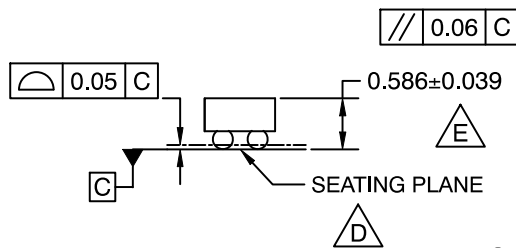
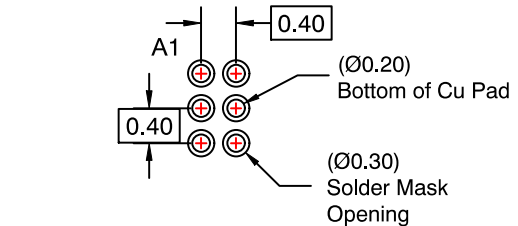
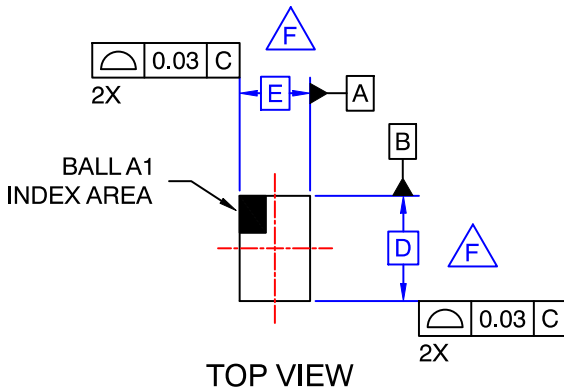

NOTES:

- A. NO JEDEC REGISTRATION APPLIES.
- B. DIMENSIONS ARE IN MILLIMETERS.
- C. DIMENSIONS AND TOLERANCES PER ASMEY14.5M, 2009.
- D.** DATUM C, THE SEATING PLANE IS DEFINED BY THE SPHERICAL CROWNS OF THE BALLS.
- E.** PACKAGE TYPICAL HEIGHT IS 586 MICRONS ±39 MICRONS (547–625 MICRONS).
- F.** FOR DIMENSIONS D, E, X, AND Y, SEE PRODUCT DATASHEET.

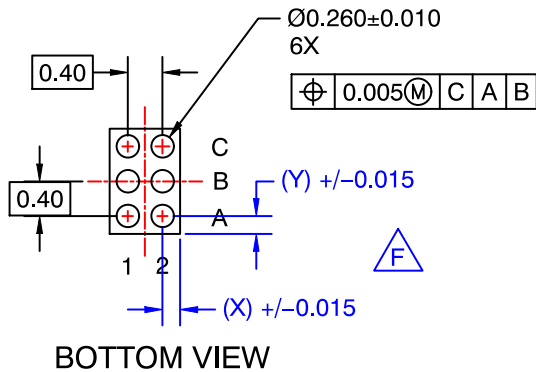

DOCUMENT NUMBER:	98AON16582G	Electronic versions are uncontrolled except when accessed directly from the Document Repository. Printed versions are uncontrolled except when stamped "CONTROLLED COPY" in red.
DESCRIPTION:	WLCSP6 1.23x0.88x0.586	PAGE 1 OF 1

onsemi and ONSEMI are trademarks of Semiconductor Components Industries, LLC dba onsemi or its subsidiaries in the United States and/or other countries. onsemi reserves the right to make changes without further notice to any products herein. onsemi makes no warranty, representation or guarantee regarding the suitability of its products for any particular purpose, nor does onsemi assume any liability arising out of the application or use of any product or circuit, and specifically disclaims any and all liability, including without limitation special, consequential or incidental damages. onsemi does not convey any license under its patent rights nor the rights of others.

onsemi, **Onsemi**, and other names, marks, and brands are registered and/or common law trademarks of Semiconductor Components Industries, LLC dba "**onsemi**" or its affiliates and/or subsidiaries in the United States and/or other countries. **onsemi** owns the rights to a number of patents, trademarks, copyrights, trade secrets, and other intellectual property. A listing of **onsemi**'s product/patent coverage may be accessed at www.onsemi.com/site/pdf/Patent-Marking.pdf. **onsemi** reserves the right to make changes at any time to any products or information herein, without notice. The information herein is provided "as-is" and **onsemi** makes no warranty, representation or guarantee regarding the accuracy of the information, product features, availability, functionality, or suitability of its products for any particular purpose, nor does **onsemi** assume any liability arising out of the application or use of any product or circuit, and specifically disclaims any and all liability, including without limitation special, consequential or incidental damages. Buyer is responsible for its products and applications using **onsemi** products, including compliance with all laws, regulations and safety requirements or standards, regardless of any support or applications information provided by **onsemi**. "Typical" parameters which may be provided in **onsemi** data sheets and/or specifications can and do vary in different applications and actual performance may vary over time. All operating parameters, including "Typicals" must be validated for each customer application by customer's technical experts. **onsemi** does not convey any license under any of its intellectual property rights nor the rights of others. **onsemi** products are not designed, intended, or authorized for use as a critical component in life support systems or any FDA Class 3 medical devices or medical devices with a same or similar classification in a foreign jurisdiction or any devices intended for implantation in the human body. Should Buyer purchase or use **onsemi** products for any such unintended or unauthorized application, Buyer shall indemnify and hold **onsemi** and its officers, employees, subsidiaries, affiliates, and distributors harmless against all claims, costs, damages, and expenses, and reasonable attorney fees arising out of, directly or indirectly, any claim of personal injury or death associated with such unintended or unauthorized use, even if such claim alleges that **onsemi** was negligent regarding the design or manufacture of the part. **onsemi** is an Equal Opportunity/Affirmative Action Employer. This literature is subject to all applicable copyright laws and is not for resale in any manner.

ADDITIONAL INFORMATION

TECHNICAL PUBLICATIONS:

Technical Library: www.onsemi.com/design/resources/technical-documentation
onsemi Website: www.onsemi.com

ONLINE SUPPORT: www.onsemi.com/support

For additional information, please contact your local Sales Representative at www.onsemi.com/support/sales