

# ESD5384

## ESD Protection Diode

### 5-Line HDMI Control Line ESD Protection

#### Functional Description

The ESD5384 chip is a low capacitance ESD protection for HDMI control pins. It also integrates pull-up resistor for I<sup>2</sup>C bus and pull-down resistor for hot plug detect and pull-up resistor for CEC line.

The ESD protection circuitry prevents damage to the protected device when subjected to ESD surges up to 15 kV.

The ESD5384 is available in 9 bump CSP package.

#### Features

- Line Capacitance: 12 pF max
- IEC 61000-4-2 Level 4
  - ◆ ±15 kV (air discharge)
  - ◆ ±8 kV (contact discharge)
- This is a Pb-Free Device

#### Applications

- HDMI Control Line Interfaces
  - ◆ Smart Phones
  - ◆ Tablets
  - ◆ Consumer Electronics



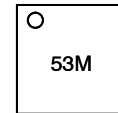
**ON Semiconductor**<sup>®</sup>

[www.onsemi.com](http://www.onsemi.com)

#### MARKING DIAGRAM

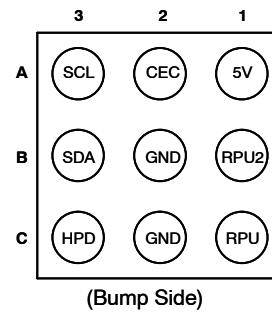


**WLCSP9  
CASE 567CX**



53 = Specific Device Code  
M = Date Code

#### PINOUT



#### ORDERING INFORMATION

See detailed ordering and shipping information in the package dimensions section on page 7 of this data sheet.

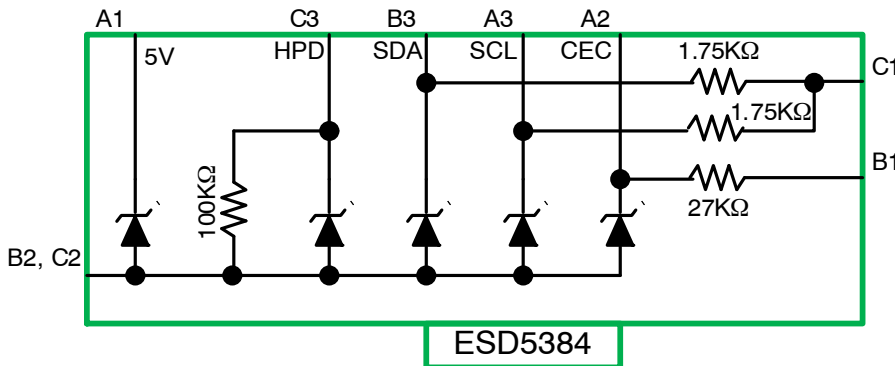


Figure 1. Electrical Schematic

# ESD5384

## ABSOLUTE MAXIMUM RATINGS

| Symbol           | Parameter                                                                                                                                                                                                                                                         | Value                     | Unit |
|------------------|-------------------------------------------------------------------------------------------------------------------------------------------------------------------------------------------------------------------------------------------------------------------|---------------------------|------|
| V <sub>PP</sub>  | External pins (A1, A2, A3, B3 and C3):<br>ESD IEC 61000-4-2, level 4 – air discharge<br>ESD IEC 61000-4-2, level 4 – contact discharge<br>Internal pins (B1, C1):<br>ESD IEC 61000-4-2, level 1 – air discharge<br>ESD IEC 61000-4-2, level 1 – contact discharge | ± 15<br>± 8<br>± 2<br>± 2 | kV   |
| T <sub>op</sub>  | Operating Temperature Range                                                                                                                                                                                                                                       | -30 to +85                | °C   |
| T <sub>stg</sub> | Storage Temperature Range                                                                                                                                                                                                                                         | -55 to +150               | °C   |

Stresses exceeding those listed in the Maximum Ratings table may damage the device. If any of these limits are exceeded, device functionality should not be assumed, damage may occur and reliability may be affected.

## ELECTRICAL CHARACTERISTICS (Note 1)

| Symbol            | Test Condition                                                                                   | Min  | Typ  | Max  | Unit |
|-------------------|--------------------------------------------------------------------------------------------------|------|------|------|------|
| V <sub>BR</sub>   | Breakdown Voltage (I <sub>r</sub> = 1mA)                                                         | 6    |      | 20   | V    |
| I <sub>RM</sub>   | Leakage Current @ V <sub>rm</sub> (V <sub>rm</sub> = 3 V per line), excluding HPD line           |      | 50   | 200  | nA   |
| I <sub>RM</sub>   | Leakage Current @ V <sub>rm</sub> (V <sub>rm</sub> = 3 V per line), HPD line                     |      |      | 32   | μA   |
| R1, R2            | Resistance                                                                                       | 1575 | 1750 | 1925 | Ω    |
| R3                | Pull-up Resistance                                                                               | 80   | 100  | 120  | kΩ   |
| R4                | Pull-up Resistance                                                                               | 22   | 27   | 32   | kΩ   |
| C <sub>line</sub> | V <sub>line</sub> = 0 V, V <sub>osc</sub> = 30 mV, F = 1 MHz, A2 with B1 not connected           |      | 14   | 17   | pF   |
|                   | V <sub>line</sub> = 0 V, V <sub>osc</sub> = 30 mV, F = 1 MHz, A3, B3 with C1 not connected.      |      | 24   | 29   |      |
|                   | V <sub>line</sub> = 0 V, V <sub>osc</sub> = 30 mV, F = 1 MHz, A2, A3, B3 with C1 and B1 grounded |      | 10   | 12   |      |

1. All parameters specified at T<sub>A</sub> = 25°C unless otherwise noted.

## TYPICAL CHARACTERISTICS

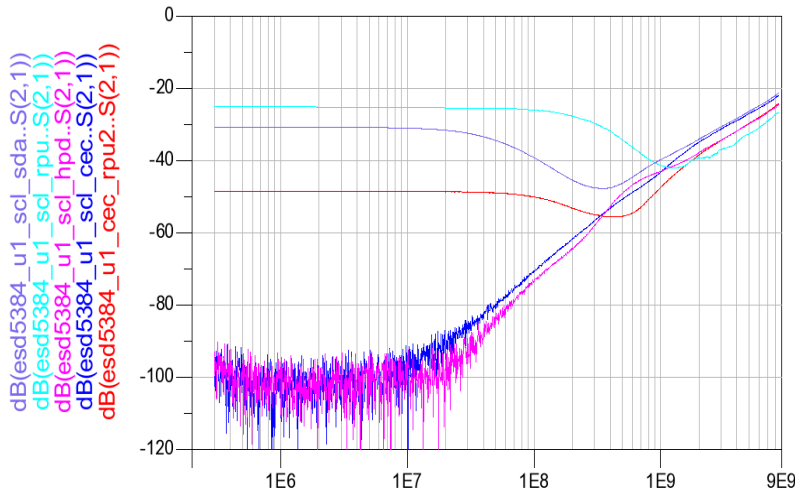
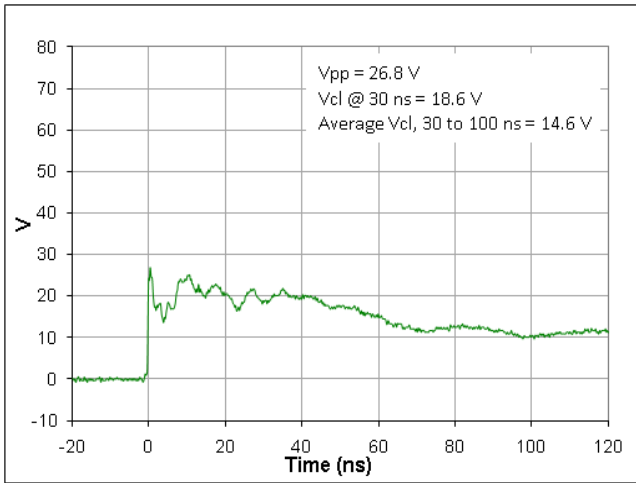
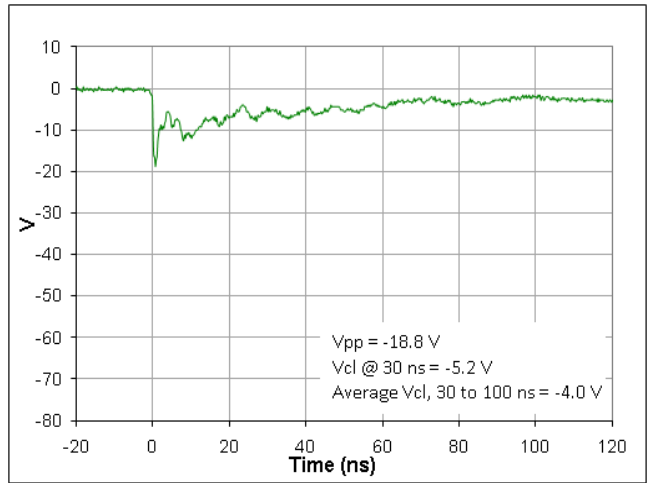


Figure 2. Crosstalk Measurements

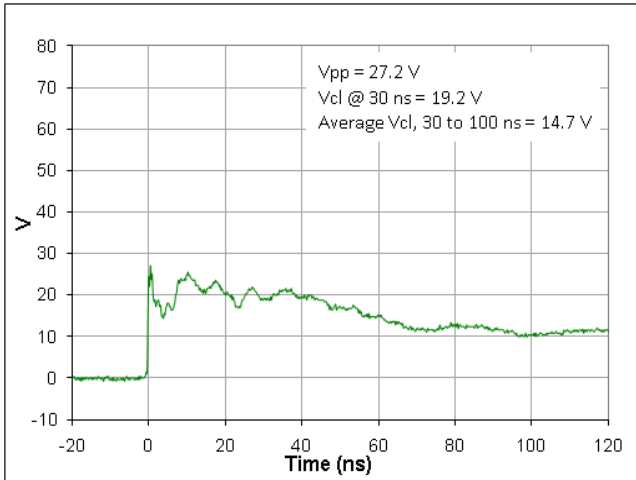
TYPICAL CHARACTERISTICS



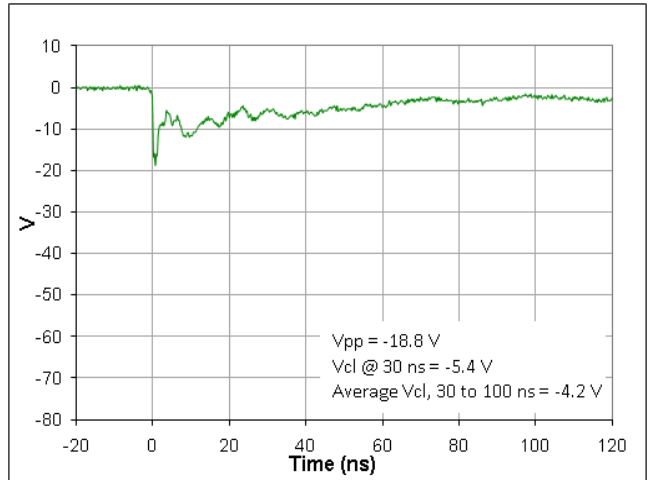
**Figure 3. ESD Clamping Voltage Screenshot Positive 8 kV Contact per IEC61000-4-2, CEC line**



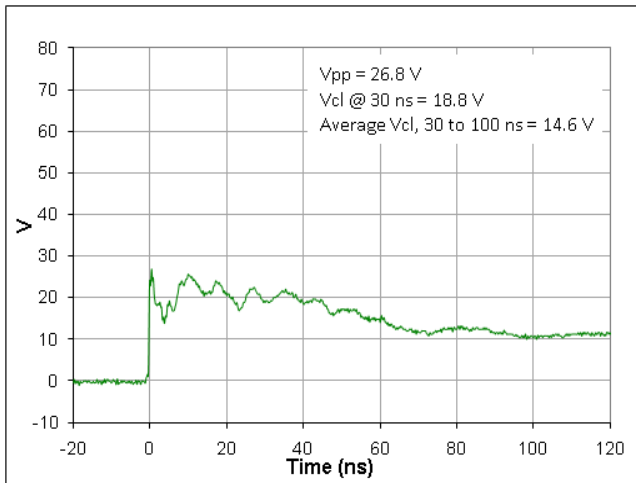
**Figure 4. ESD Clamping Voltage Screenshot Negative 8 kV Contact per IEC61000-4-2, CEC line**



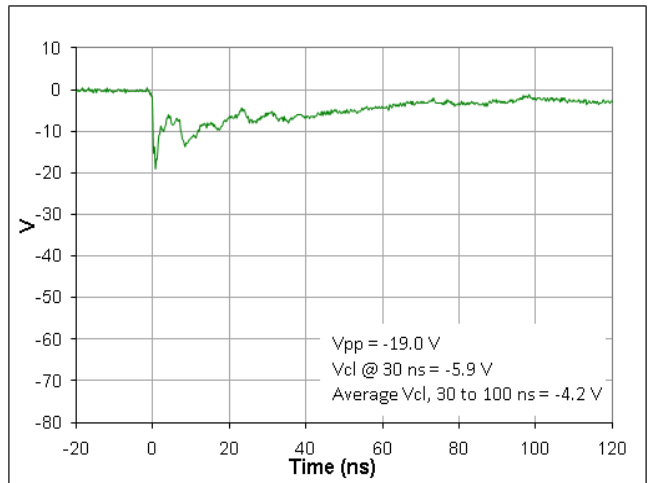
**Figure 5. ESD Clamping Voltage Screenshot Positive 8 kV Contact per IEC61000-4-2, SCL line**



**Figure 6. ESD Clamping Voltage Screenshot Negative 8 kV Contact per IEC61000-4-2, SCL line**

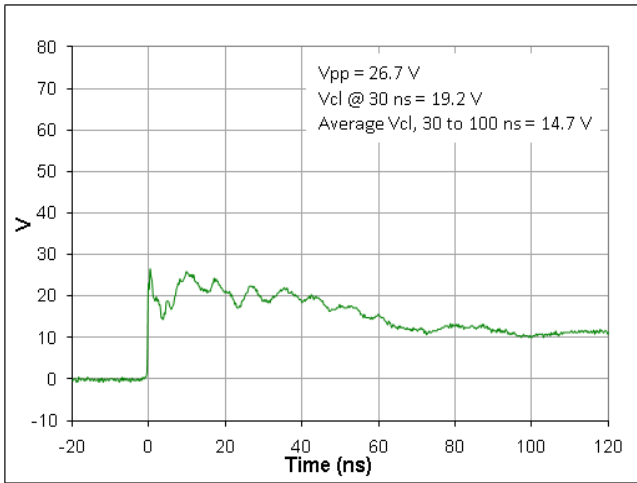


**Figure 7. ESD Clamping Voltage Screenshot Positive 8 kV Contact per IEC61000-4-2, SDA line**

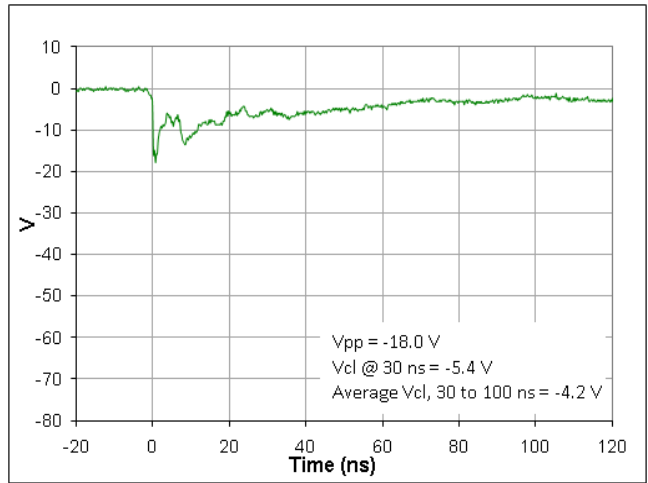


**Figure 8. ESD Clamping Voltage Screenshot Negative 8 kV Contact per IEC61000-4-2, SDA line**

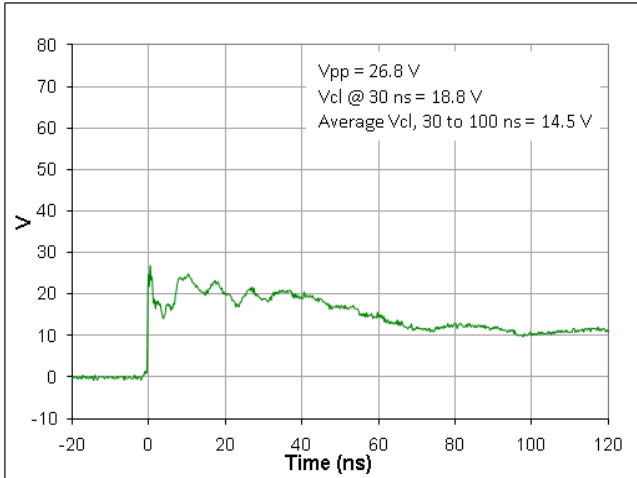
TYPICAL CHARACTERISTICS



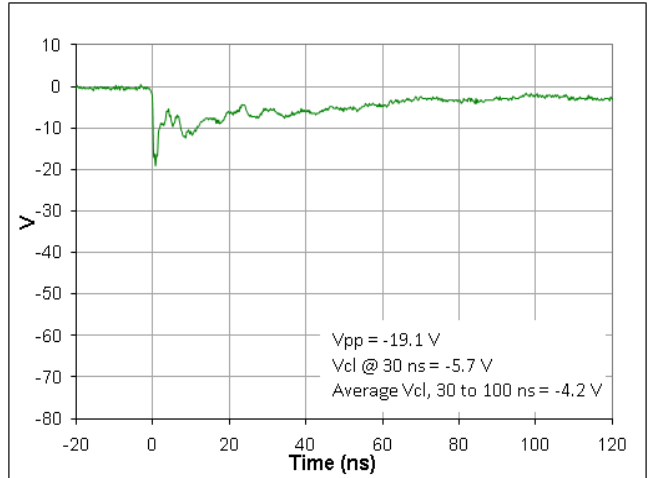
**Figure 9. ESD Clamping Voltage Screenshot Positive 8 kV Contact per IEC61000-4-2, HPD line**



**Figure 10. ESD Clamping Voltage Screenshot Negative 8 kV Contact per IEC61000-4-2, HPD line**



**Figure 11. ESD Clamping Voltage Screenshot Positive 8 kV Contact per IEC61000-4-2, 5 V line**



**Figure 12. ESD Clamping Voltage Screenshot Negative 8 kV Contact per IEC61000-4-2, 5 V line**

IEC61000-4-2 Spec.

| Level | Test Voltage (kV) | First Peak Current (A) | Current at 30 ns (A) | Current at 60 ns (A) |
|-------|-------------------|------------------------|----------------------|----------------------|
| 1     | 2                 | 7.5                    | 4                    | 2                    |
| 2     | 4                 | 15                     | 8                    | 4                    |
| 3     | 6                 | 22.5                   | 12                   | 6                    |
| 4     | 8                 | 30                     | 16                   | 8                    |



Figure 13. IEC61000-4-2 Spec

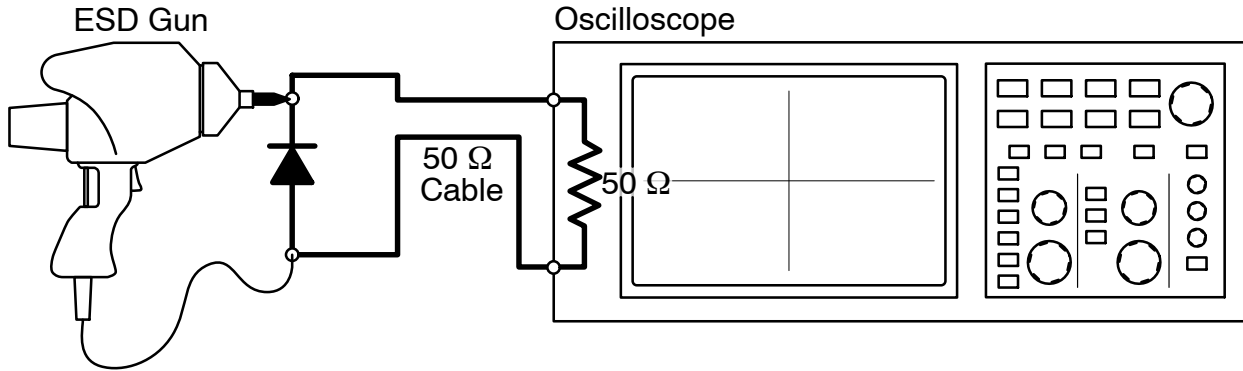


Figure 14. Diagram of ESD Clamping Voltage Test Setup

The following is taken from Application Note AND8308/D – Interpretation of Datasheet Parameters for ESD Devices.

ESD Voltage Clamping

For sensitive circuit elements it is important to limit the voltage that an IC will be exposed to during an ESD event to as low a voltage as possible. The ESD clamping voltage is the voltage drop across the ESD protection diode during an ESD event per the IEC61000-4-2 waveform. Since the IEC61000-4-2 was written as a pass/fail spec for larger

systems such as cell phones or laptop computers it is not clearly defined in the spec how to specify a clamping voltage at the device level. ON Semiconductor has developed a way to examine the entire voltage waveform across the ESD protection diode over the time domain of an ESD pulse in the form of an oscilloscope screenshot, which can be found on the datasheets for all ESD protection diodes. For more information on how ON Semiconductor creates these screenshots and how to interpret them please refer to AND8307/D.

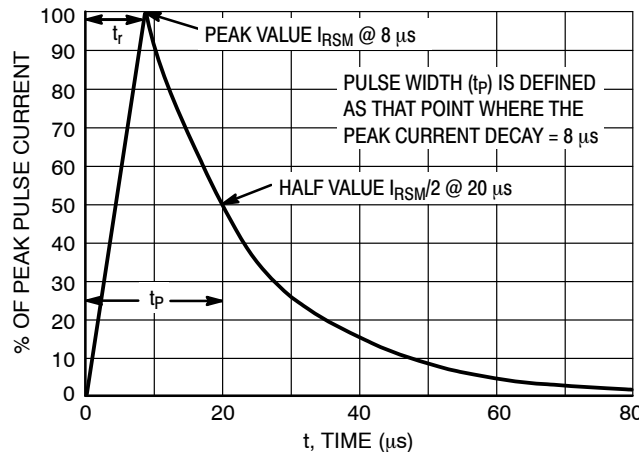


Figure 15. 8 x 20  $\mu s$  Pulse Waveform

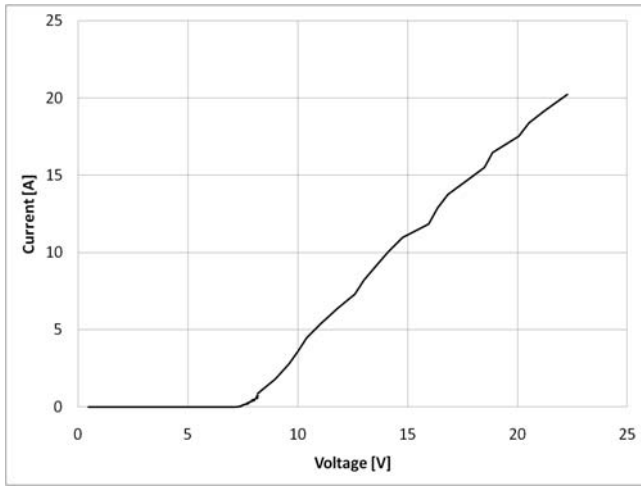


Figure 16. Positive TLP I-V Curve

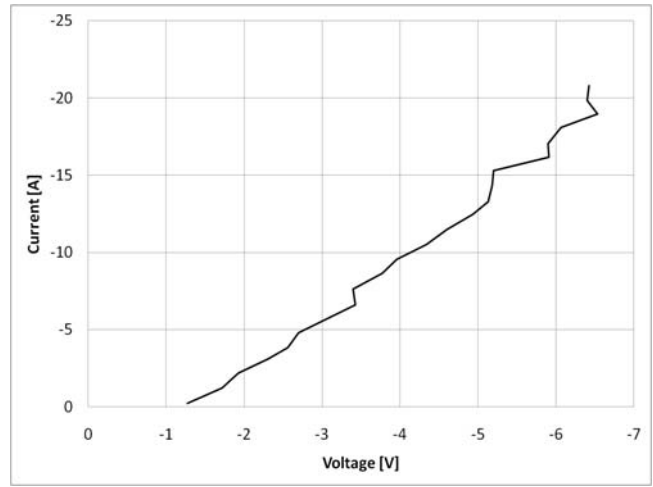


Figure 17. Negative TLP I-V Curve

**Transmission Line Pulse (TLP) Measurement**

Transmission Line Pulse (TLP) provides current versus voltage (I-V) curves in which each data point is obtained from a 100 ns long rectangular pulse from a charged transmission line. A simplified schematic of a typical TLP system is shown in Figure 18. TLP I-V curves of ESD protection devices accurately demonstrate the product’s ESD capability because the 10s of amps current levels and under 100 ns time scale match those of an ESD event. This is illustrated in Figure 19 where an 8 kV IEC61000-4-2 current waveform is compared with TLP current pulses at 8 A and 16 A. A TLP I-V curve shows the voltage at which the device turns on as well as how well the device clamps voltage over a range of current levels. A typical TLP I-V curve for the ESD7383 is shown in Figures 16 and 17.

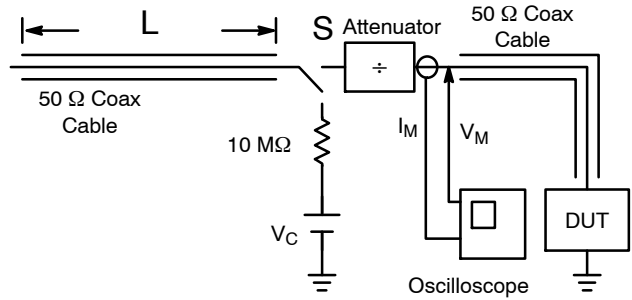


Figure 18. Simplified Schematic of a Typical TLP System

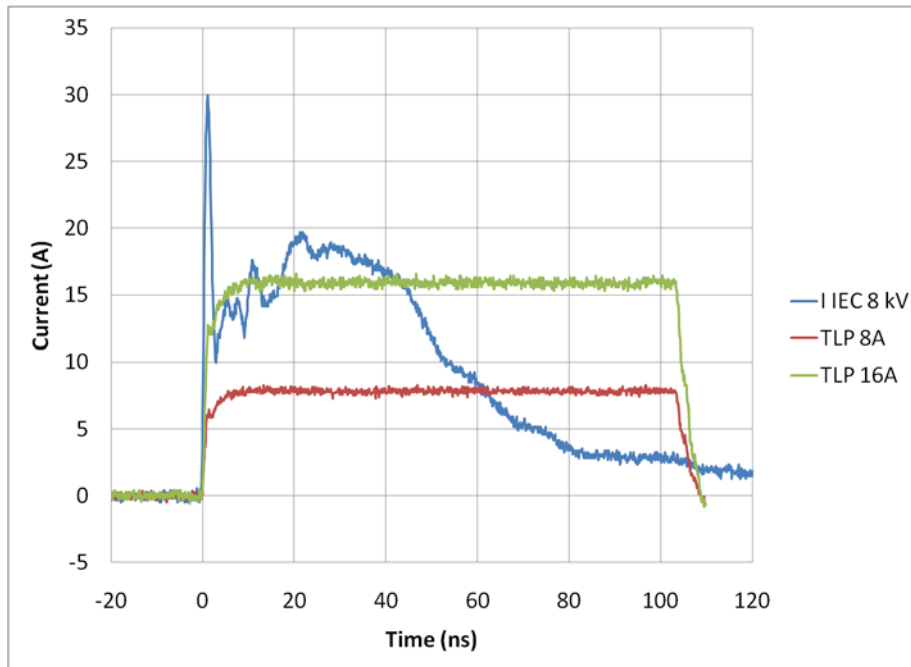


Figure 19. Comparison Between 8 kV IEC61000-4-2 and 8 A and 16 A TLP Waveforms

# ESD5384

## TYPICAL APPLICATION SCHEMATIC

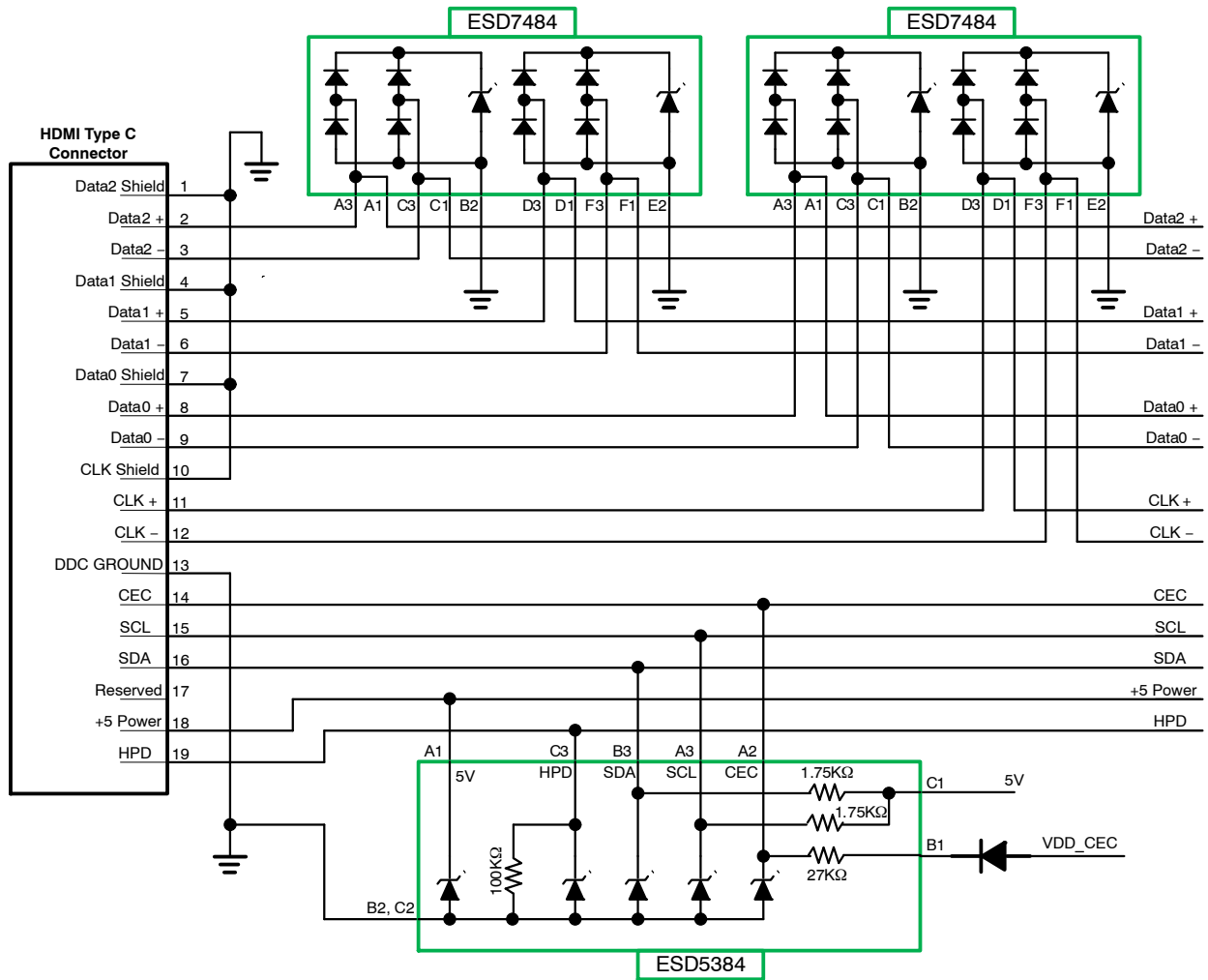


Figure 20. Typical Application Schematic

### ORDERING INFORMATION

| Part Number | Chip Size (mm)      | Package             | Shipping <sup>†</sup> |
|-------------|---------------------|---------------------|-----------------------|
| ESD5384     | 1.14 x 1.14 x 0.605 | WLCSP9<br>(Pb-Free) | 5000 / Tape & Reel    |

<sup>†</sup>For information on tape and reel specifications, including part orientation and tape sizes, please refer to our Tape and Reel Packaging Specifications Brochure, BRD8011/D.

# MECHANICAL CASE OUTLINE PACKAGE DIMENSIONS

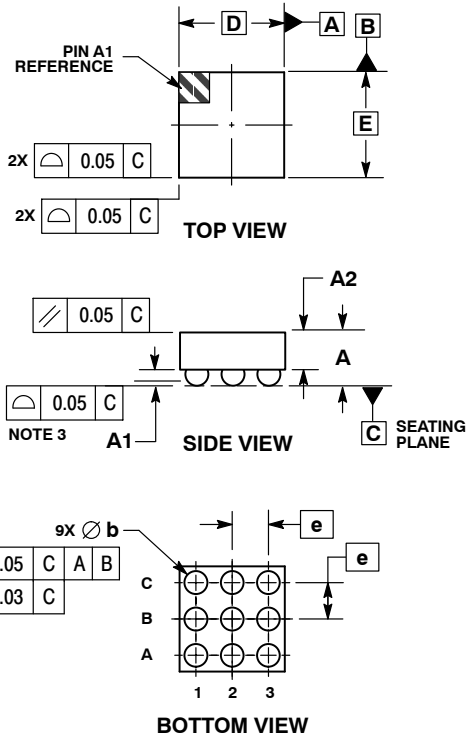
ON Semiconductor®



SCALE 4:1

WLCSP9, 1.14x1.14  
CASE 567CX-01  
ISSUE O

DATE 22 OCT 2010

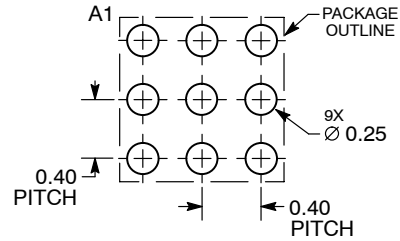


NOTES:

1. DIMENSIONING AND TOLERANCING PER ASME Y14.5M, 1994.
2. CONTROLLING DIMENSION: MILLIMETERS.
3. COPLANARITY APPLIES TO SPHERICAL CROWNS OF SOLDER BALLS.

| DIM | MILLIMETERS |      |
|-----|-------------|------|
|     | MIN         | MAX  |
| A   | 0.57        | 0.63 |
| A1  | 0.17        | 0.24 |
| A2  | 0.41 REF    |      |
| b   | 0.24        | 0.29 |
| D   | 1.14 BSC    |      |
| E   | 1.14 BSC    |      |
| e   | 0.40 BSC    |      |

**RECOMMENDED  
SOLDERING FOOTPRINT\***



DIMENSIONS: MILLIMETERS

\*For additional information on our Pb-Free strategy and soldering details, please download the ON Semiconductor Soldering and Mounting Techniques Reference Manual, SOLDERRM/D.

|                         |                          |                                                                                                                                                                                  |
|-------------------------|--------------------------|----------------------------------------------------------------------------------------------------------------------------------------------------------------------------------|
| <b>DOCUMENT NUMBER:</b> | <b>98AON54062E</b>       | Electronic versions are uncontrolled except when accessed directly from the Document Repository. Printed versions are uncontrolled except when stamped "CONTROLLED COPY" in red. |
| <b>DESCRIPTION:</b>     | <b>WLCSP9, 1.14X1.14</b> | <b>PAGE 1 OF 1</b>                                                                                                                                                               |

ON Semiconductor and are trademarks of Semiconductor Components Industries, LLC dba ON Semiconductor or its subsidiaries in the United States and/or other countries. ON Semiconductor reserves the right to make changes without further notice to any products herein. ON Semiconductor makes no warranty, representation or guarantee regarding the suitability of its products for any particular purpose, nor does ON Semiconductor assume any liability arising out of the application or use of any product or circuit, and specifically disclaims any and all liability, including without limitation special, consequential or incidental damages. ON Semiconductor does not convey any license under its patent rights nor the rights of others.



**onsemi**, **Onsemi**, and other names, marks, and brands are registered and/or common law trademarks of Semiconductor Components Industries, LLC dba "**onsemi**" or its affiliates and/or subsidiaries in the United States and/or other countries. **onsemi** owns the rights to a number of patents, trademarks, copyrights, trade secrets, and other intellectual property. A listing of **onsemi**'s product/patent coverage may be accessed at [www.onsemi.com/site/pdf/Patent-Marking.pdf](http://www.onsemi.com/site/pdf/Patent-Marking.pdf). **onsemi** reserves the right to make changes at any time to any products or information herein, without notice. The information herein is provided "as-is" and **onsemi** makes no warranty, representation or guarantee regarding the accuracy of the information, product features, availability, functionality, or suitability of its products for any particular purpose, nor does **onsemi** assume any liability arising out of the application or use of any product or circuit, and specifically disclaims any and all liability, including without limitation special, consequential or incidental damages. Buyer is responsible for its products and applications using **onsemi** products, including compliance with all laws, regulations and safety requirements or standards, regardless of any support or applications information provided by **onsemi**. "Typical" parameters which may be provided in **onsemi** data sheets and/or specifications can and do vary in different applications and actual performance may vary over time. All operating parameters, including "Typicals" must be validated for each customer application by customer's technical experts. **onsemi** does not convey any license under any of its intellectual property rights nor the rights of others. **onsemi** products are not designed, intended, or authorized for use as a critical component in life support systems or any FDA Class 3 medical devices or medical devices with a same or similar classification in a foreign jurisdiction or any devices intended for implantation in the human body. Should Buyer purchase or use **onsemi** products for any such unintended or unauthorized application, Buyer shall indemnify and hold **onsemi** and its officers, employees, subsidiaries, affiliates, and distributors harmless against all claims, costs, damages, and expenses, and reasonable attorney fees arising out of, directly or indirectly, any claim of personal injury or death associated with such unintended or unauthorized use, even if such claim alleges that **onsemi** was negligent regarding the design or manufacture of the part. **onsemi** is an Equal Opportunity/Affirmative Action Employer. This literature is subject to all applicable copyright laws and is not for resale in any manner.

## ADDITIONAL INFORMATION

### TECHNICAL PUBLICATIONS:

Technical Library: [www.onsemi.com/design/resources/technical-documentation](http://www.onsemi.com/design/resources/technical-documentation)  
onsemi Website: [www.onsemi.com](http://www.onsemi.com)

### ONLINE SUPPORT: [www.onsemi.com/support](http://www.onsemi.com/support)

For additional information, please contact your local Sales Representative at [www.onsemi.com/support/sales](http://www.onsemi.com/support/sales)