

Small Signal Diode

BAV19



**AXIAL LEAD
(DO-35)
CASE 017AG**
(Color Band Denotes Cathode)

ABSOLUTE MAXIMUM RATINGS

($T_A = 25^\circ\text{C}$ unless otherwise noted) (Notes 1, 2, 3)

Symbol	Parameter	Value	Units
V_{RRM}	Maximum Repetitive Reverse Voltage	120	V
$I_{F(AV)}$	Average Rectified Forward Current	200	mA
I_{FSM}	Non-repetitive Peak Forward Surge Current Pulse Width = 1.0 s Pulse Width = 1.0 μs	1.0 4.0	A
T_{STG}	Storage Temperature Range	-65 to +200	$^\circ\text{C}$
T_J	Operating Junction Temperature	175	$^\circ\text{C}$

Stresses exceeding those listed in the Maximum Ratings table may damage the device. If any of these limits are exceeded, device functionality should not be assumed, damage may occur and reliability may be affected.

1. These ratings are limiting values above which the serviceability of the diode may be impaired.
2. These ratings are based on a maximum junction temperature of 200°C .
3. These are steady limits. The factory should be consulted on applications involving pulsed or low duty cycle operations.

THERMAL CHARACTERISTICS

Symbol	Parameter	Value	Units
P_D	Power Dissipation	500	mW
$R_{\theta JA}$	Thermal Resistance, Junction to Ambient	300	$^\circ\text{C}/\text{W}$

ELECTRICAL CHARACTERISTICS

($T_A = 25^\circ\text{C}$ unless otherwise noted)

Symbol	Parameter	Test Conditions	Min	Max	Units
V_R	Breakdown Voltage	$I_R = 100 \mu\text{A}$	120	-	V
V_F	Forward Voltage	$I_F = 100 \text{ mA}$ $I_F = 200 \text{ mA}$	-	1.0 1.25	V
I_R	Reverse Current	$V_R = 100 \text{ V}$ $V_R = 100 \text{ V}, T_A = 150^\circ\text{C}$	-	100 100	nA μA
C_T	Total Capacitance	$V_R = 0, f = 1.0 \text{ MHz}$	-	5.0	pF
t_{rr}	Reverse Recovery Time	$I_F = I_R = 30 \text{ mA}$, $I_{RR} = 3.0 \text{ mA}$, $R_L = 100 \Omega$	-	50	ns

Product parametric performance is indicated in the Electrical Characteristics for the listed test conditions, unless otherwise noted. Product performance may not be indicated by the Electrical Characteristics if operated under different conditions.

MARKING DIAGRAM

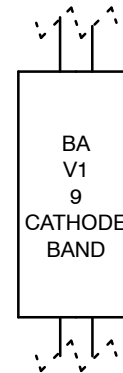

BAV19 = Specific Device Code

ORDERING INFORMATION

Device	Package	Shipping [†]
BAV19TR	DO-35 (Pb-Free)	10,000 Units / Tape & Reel

[†]For information on tape and reel specifications, including part orientation and tape sizes, please refer to our Tape and Reel Packaging Specifications Brochure, BRD8011/D.

TYPICAL CHARACTERISTICS

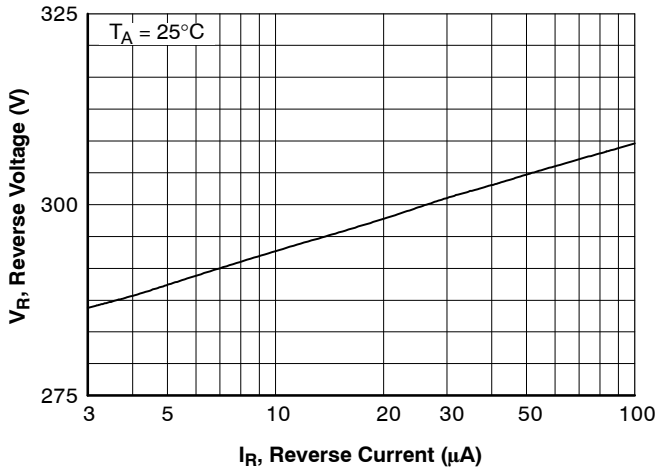

Figure 1. Reverse Voltage vs. Reverse Current
 $B_V - 1.0$ to $100 \mu A$ $T_A = 25^\circ C$

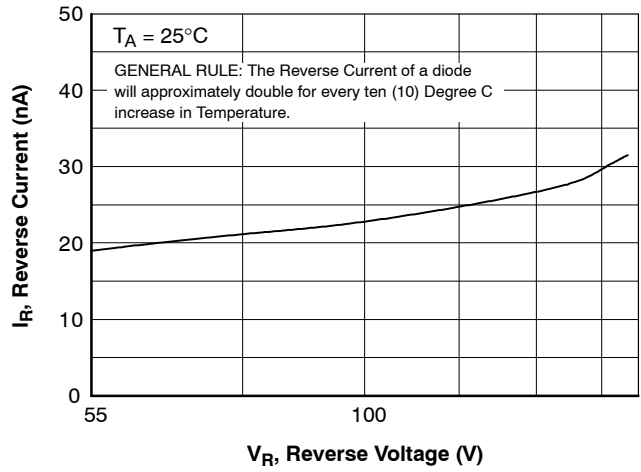

Figure 2. Reverse Current vs. Reverse Voltage
 $I_R - 55$ to $205 V$

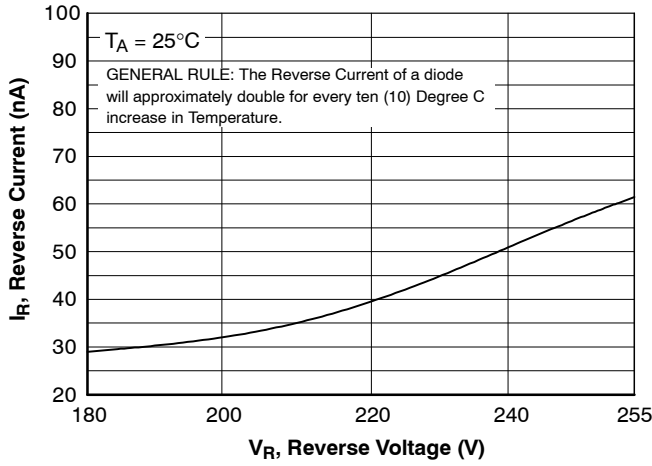

Figure 3. Reverse Current vs. Reverse Voltage
 $I_R - 180$ to $225 V$

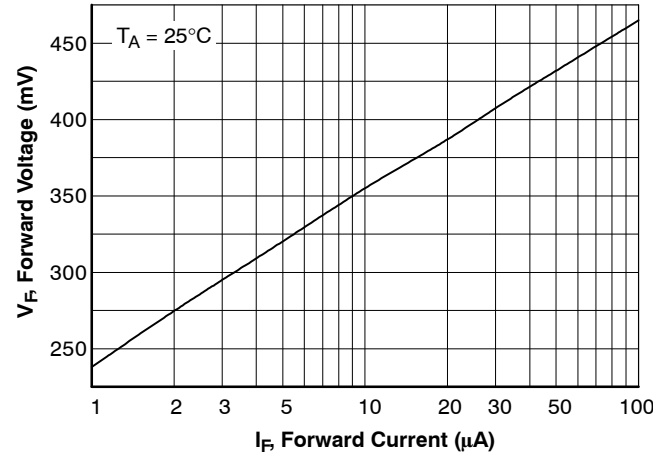

Figure 4. Forward Voltage vs. Forward Current
 $V_F - 1.0$ to $100 \mu A$

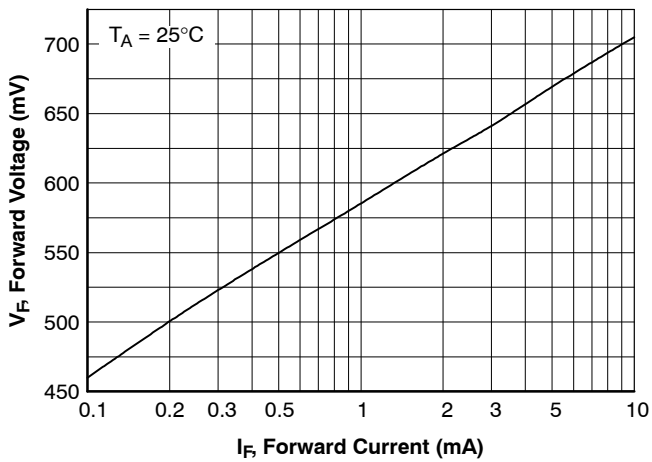

Figure 5. Forward Voltage vs. Forward Current
 $V_F - 0.1$ to $10 mA$

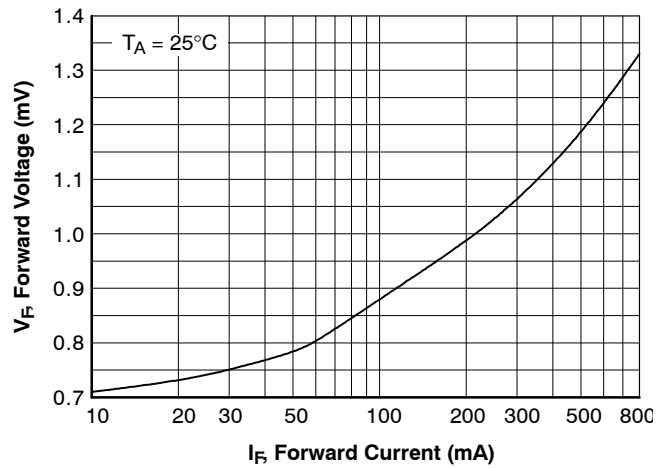

Figure 6. Forward Voltage vs. Forward Current
 $V_F - 10$ to $800 mA$

BAV19

TYPICAL CHARACTERISTICS (continued)

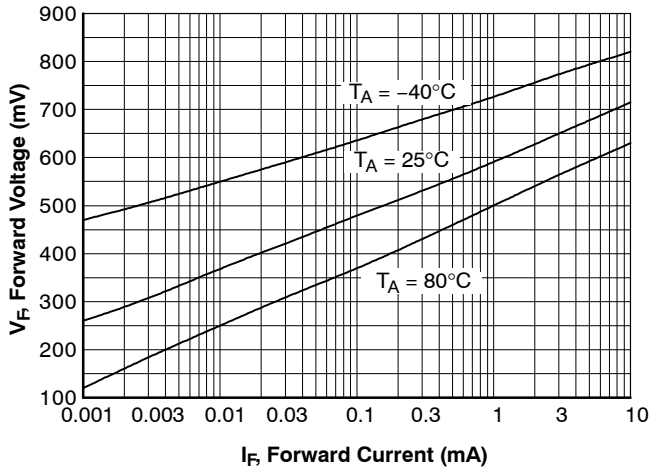

Figure 7. Forward Voltage vs. Ambient Temperature
 $V_F - 0.1 \mu\text{A} - 10 \text{ mA} (-40 \text{ to } +80^\circ\text{C})$

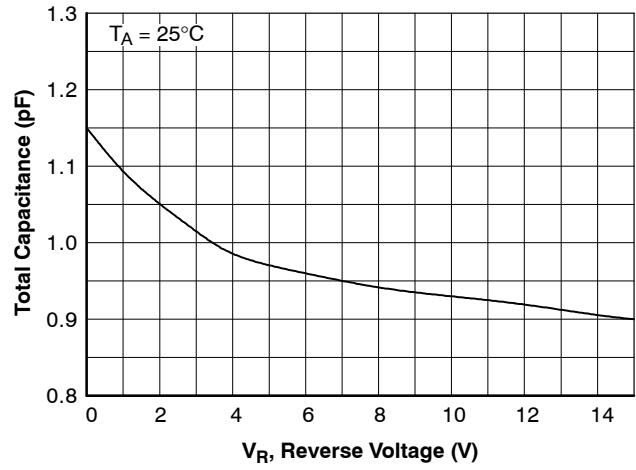

Figure 8. Total Capacitance

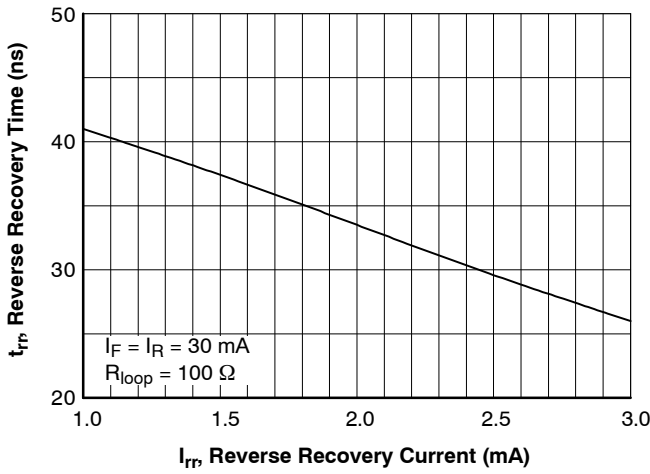

Figure 9. Reverse Recovery Time vs. Reverse Recovery Current

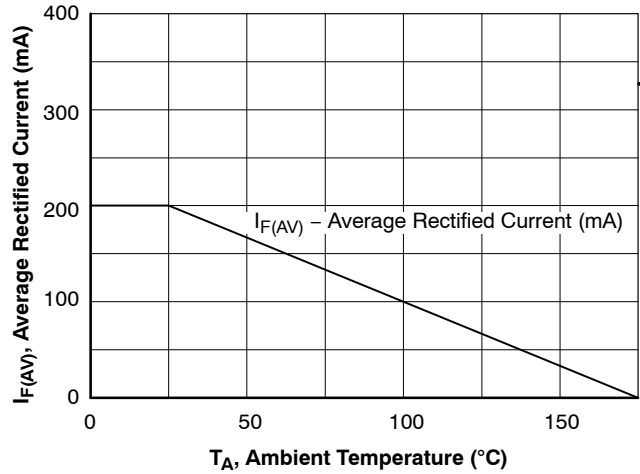

Figure 10. Average Rectified Current ($I_{F(AV)}$) vs. Ambient Temperature (T_A)

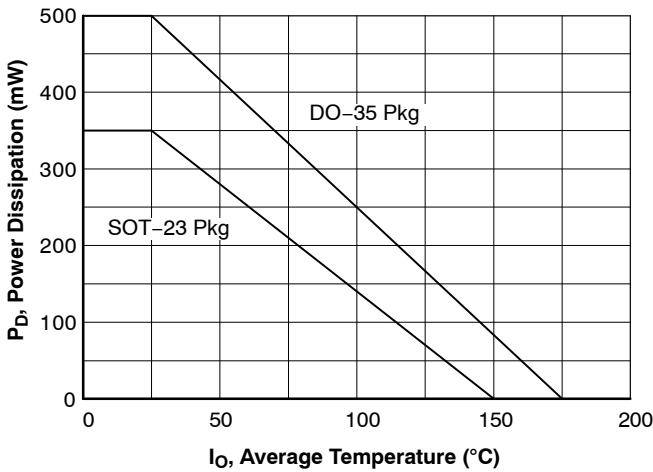
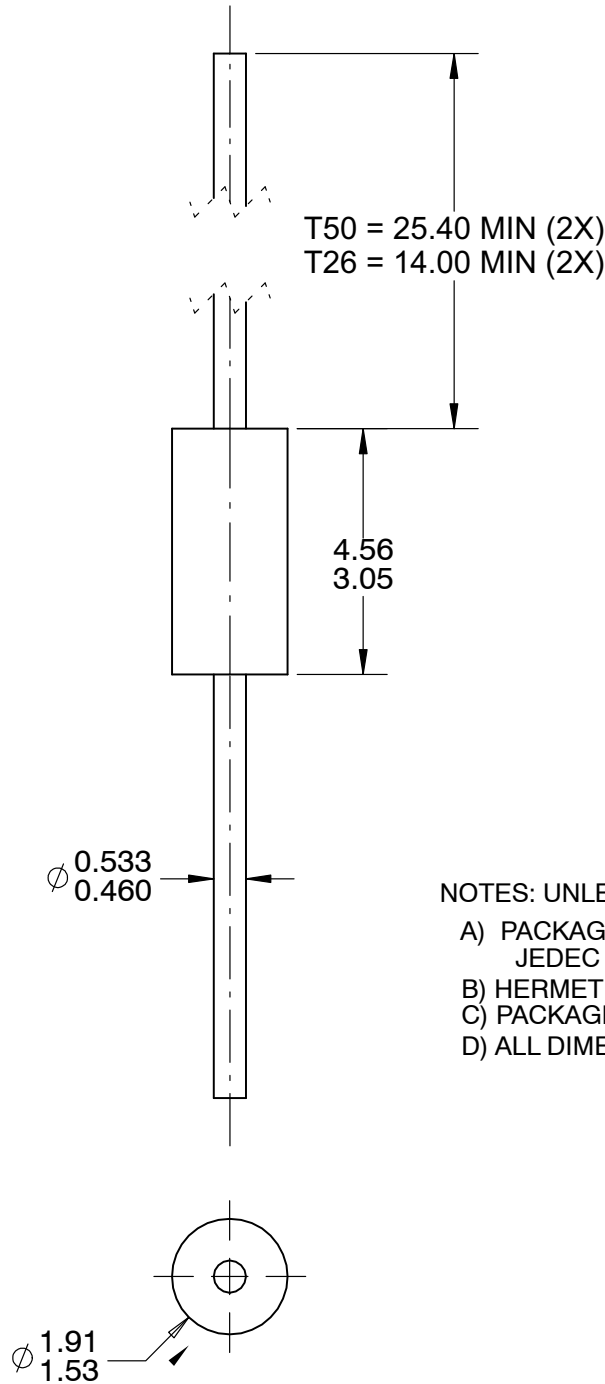

Figure 11. Power Derating Curve

AXIAL LEAD
CASE 017AG
ISSUE 0

DATE 31 AUG 2016



- NOTES: UNLESS OTHERWISE SPECIFIED
- A) PACKAGE STANDARD REFERENCE: JEDEC DO-204, VARIATION AH.
 - B) HERMETICALLY SEALED GLASS PACKAGE.
 - C) PACKAGE WEIGHT IS 0.137 GRAM.
 - D) ALL DIMENSIONS ARE IN MILLIMETERS.

DOCUMENT NUMBER:	98AON13443G	Electronic versions are uncontrolled except when accessed directly from the Document Repository. Printed versions are uncontrolled except when stamped "CONTROLLED COPY" in red.
DESCRIPTION:	AXIAL LEAD	PAGE 1 OF 1

ON Semiconductor and  are trademarks of Semiconductor Components Industries, LLC dba ON Semiconductor or its subsidiaries in the United States and/or other countries. ON Semiconductor reserves the right to make changes without further notice to any products herein. ON Semiconductor makes no warranty, representation or guarantee regarding the suitability of its products for any particular purpose, nor does ON Semiconductor assume any liability arising out of the application or use of any product or circuit, and specifically disclaims any and all liability, including without limitation special, consequential or incidental damages. ON Semiconductor does not convey any license under its patent rights nor the rights of others.

onsemi, **Onsemi**, and other names, marks, and brands are registered and/or common law trademarks of Semiconductor Components Industries, LLC dba "**onsemi**" or its affiliates and/or subsidiaries in the United States and/or other countries. **onsemi** owns the rights to a number of patents, trademarks, copyrights, trade secrets, and other intellectual property. A listing of **onsemi**'s product/patent coverage may be accessed at www.onsemi.com/site/pdf/Patent-Marking.pdf. **onsemi** reserves the right to make changes at any time to any products or information herein, without notice. The information herein is provided "as-is" and **onsemi** makes no warranty, representation or guarantee regarding the accuracy of the information, product features, availability, functionality, or suitability of its products for any particular purpose, nor does **onsemi** assume any liability arising out of the application or use of any product or circuit, and specifically disclaims any and all liability, including without limitation special, consequential or incidental damages. Buyer is responsible for its products and applications using **onsemi** products, including compliance with all laws, regulations and safety requirements or standards, regardless of any support or applications information provided by **onsemi**. "Typical" parameters which may be provided in **onsemi** data sheets and/or specifications can and do vary in different applications and actual performance may vary over time. All operating parameters, including "Typicals" must be validated for each customer application by customer's technical experts. **onsemi** does not convey any license under any of its intellectual property rights nor the rights of others. **onsemi** products are not designed, intended, or authorized for use as a critical component in life support systems or any FDA Class 3 medical devices or medical devices with a same or similar classification in a foreign jurisdiction or any devices intended for implantation in the human body. Should Buyer purchase or use **onsemi** products for any such unintended or unauthorized application, Buyer shall indemnify and hold **onsemi** and its officers, employees, subsidiaries, affiliates, and distributors harmless against all claims, costs, damages, and expenses, and reasonable attorney fees arising out of, directly or indirectly, any claim of personal injury or death associated with such unintended or unauthorized use, even if such claim alleges that **onsemi** was negligent regarding the design or manufacture of the part. **onsemi** is an Equal Opportunity/Affirmative Action Employer. This literature is subject to all applicable copyright laws and is not for resale in any manner.

ADDITIONAL INFORMATION

TECHNICAL PUBLICATIONS:

Technical Library: www.onsemi.com/design/resources/technical-documentation
onsemi Website: www.onsemi.com

ONLINE SUPPORT: www.onsemi.com/support

For additional information, please contact your local Sales Representative at www.onsemi.com/support/sales

