

# SiC Power MOSFET Module

## 1200 V, 40 mΩ, 31 A 3-Phase Bridge Power Module NVXK2VR40WDT2

### Features

- DIP Silicon Carbide 3-Phase Bridge Power Module for On-board Charger (OBC) for xEV Applications
- Creepage and Clearance per IEC 60664-1, IEC 60950-1
- Compact Design for Low Total Module Resistance
- Module Serialization for Full Traceability
- Lead Free, ROHS and UL94V-0 Compliant
- Automotive Qualified per AEC-Q101 and AQG324

### Typical Applications

- PFC for On-Board Charger in xEV Applications

### MAXIMUM RATINGS (T<sub>J</sub> = 25°C unless otherwise noted)

Parameter	Symbol	Value	Unit
Drain-to-Source Voltage	V <sub>DSS</sub>	1200	V
Gate-to-Source Voltage	V <sub>GS</sub>	+25/-15	V
Recommended Operation Values of Gate-to-Source Voltage, T <sub>J</sub> ≤ 175°C			
Continuous Drain Current (Note 1)	T <sub>C</sub> = 25°C	I <sub>D</sub>	31 A
		P <sub>D</sub>	102 W
Power Dissipation (Note 1)			
Pulsed Drain Current (Note 2)	T <sub>C</sub> = 25°C t <sub>p</sub> = 100 μs	I <sub>DM</sub>	170 A
Single Pulse Surge Drain Current Capability	T <sub>C</sub> = 25°C, t <sub>p</sub> = 10 μs, R <sub>G</sub> = 4.7 Ω	I <sub>DSC</sub>	403 A
Operating Junction Temperature	T <sub>J</sub>	-55 to 175	°C
Storage Temperature	T <sub>stg</sub>	-40 to 125	°C
Source Current (Body Diode)	I <sub>S</sub>	27	A
Single Pulse Drain-to-Source Avalanche Energy (Note 3)	E <sub>AS</sub>	338	mJ

Stresses exceeding those listed in the Maximum Ratings table may damage the device. If any of these limits are exceeded, device functionality should not be assumed, damage may occur and reliability may be affected.

### THERMAL CHARACTERISTICS (Note 1)

Parameter	Symbol	Typ	Max	Unit
Thermal Resistance Junction-to-Case (Note 1)	R <sub>θJC</sub>	1.13	1.47	°C/W
Thermal Resistance Junction-to-Sink (Note 1)	R <sub>ψJS</sub>	1.59	1.93	°C/W

1. Particular conditions specified determine thermal resistance values shown. Infinite heatsink with T<sub>C</sub> = 100°C for R<sub>θJC</sub>. For R<sub>ψJS</sub> assembled to 3 mm thick aluminum heatsink with infinite cooling bottom surface at 85°C, through 38 μm thick TIM with 6.5 W/mK thermal conductivity.
2. Repetitive rating limited by maximum junction temperature and transconductance.
3. E<sub>AS</sub> based on initial T<sub>J</sub> = 25°C, L = 1 mH, I<sub>AS</sub> = 26 A, V<sub>DD</sub> = 120 V, V<sub>GS</sub> = 18 V.

V <sub>(BR)DSS</sub>	R <sub>DS(on) Max</sub>	I <sub>D Max</sub>
1200 V	59 mΩ @ 20 V	31 A

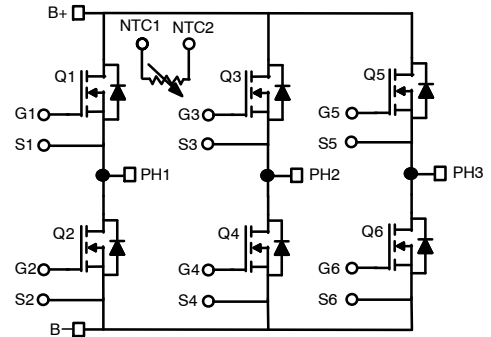

SiC MOSFET 3-Phase Bridge Module

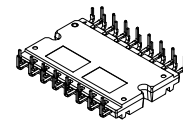

APM32  
44.00x28.80x5.70  
CASE MODHM

### MARKING DIAGRAM

NVXK2VR40WDT2  
ZZZ ATYWW  
NNNNNNN

NVXK2VR40WDT2 = Specific Device Code  
ZZZ = Lot Number  
AT = Assembly Site & Test Location  
Y = Year  
W = Work Week  
NNN = Serial Number

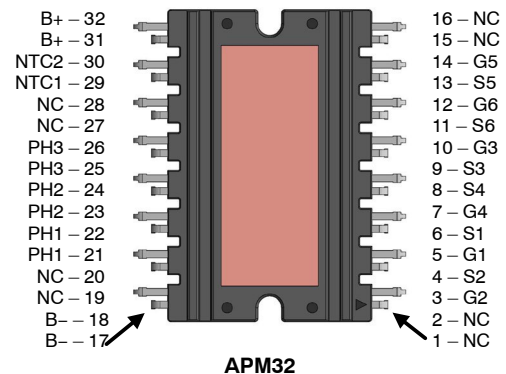

### ORDERING INFORMATION

Device	Package	Shipping
NVXK2VR40WDT2	APM32 (Pb-Free)	10 ea / Tube

# NVXK2VR40WDT2

## PIN DESCRIPTION

Pin No.	Pin Name	Description
1, 2, 15, 16, 19, 20, 27, 28	NC	Not Connected
3	G2	Q2 Gate
4	S2	Q2 Source
5	G1	Q1 Gate
6	S1	Q1 Source
7	G4	Q4 Gate
8	S4	Q4 Source
9	S3	Q3 Source
10	G3	Q3 Gate
11	S6	Q6 Source
12	G6	Q6 Gate
13	S5	Q5 Source
14	G5	Q5 Gate
17, 18	B-	Negative Power Terminal
21, 22	PH1	Phase 1 Output
23, 24	PH2	Phase 2 Output
25, 26	PH3	Phase 3 Output
29	NTC1	NTC Pin1
30	NTC2	NTC Pin2
31, 32	B+	Positive Power Terminal

## ELECTRICAL CHARACTERISTICS (T<sub>J</sub> = 25°C unless otherwise stated)

Parameter	Symbol	Test Conditions	Min	Typ	Max	Unit
-----------	--------	-----------------	-----	-----	-----	------

### OFF CHARACTERISTICS

Drain-to-Source Breakdown Voltage	V <sub>(BR)DSS</sub>	V <sub>GS</sub> = 0 V, I <sub>D</sub> = 1 mA	1200	-	-	V	
Drain-to-Source Breakdown Voltage Temperature Coefficient	B <sub>(BR)DSS</sub> /T <sub>J</sub>	I <sub>D</sub> = 1 mA, referenced to 25°C	-	450	-	mV/°C	
Zero Gate Voltage Drain Current	I <sub>DSS</sub>	V <sub>GS</sub> = 0 V, V <sub>DS</sub> = 1200 V	T <sub>J</sub> = 25°C	-	-	100	μA
			T <sub>J</sub> = 175°C	-	-	1	mA
Gate-to-Source Leakage Current	I <sub>GSS</sub>	V <sub>GS</sub> = +25/-15 V, V <sub>DS</sub> = 0 V	-	-	±1	μA	

### ON CHARACTERISTICS (Note 4)

Gate Threshold Voltage	V <sub>GS(TH)</sub>	V <sub>GS</sub> = V <sub>DS</sub> , I <sub>D</sub> = 10 mA	1.8	3	4.3	V
Recommended Gate Voltage	V <sub>GOP</sub>		-5	-	+20	V
Drain-to-Source On Resistance	R <sub>DS(on)</sub>	V <sub>GS</sub> = 20 V, I <sub>D</sub> = 35 A, T <sub>J</sub> = 25°C	-	40	59	mΩ
		V <sub>GS</sub> = 20 V, I <sub>D</sub> = 35 A, T <sub>J</sub> = 175°C	-	71	-	mΩ
Forward Transconductance	g <sub>FS</sub>	V <sub>DS</sub> = 20 V, I <sub>D</sub> = 35 A	-	20	-	S

### CHARGES, CAPACITANCES & GATE RESISTANCE

Input Capacitance	C <sub>ISS</sub>	V <sub>GS</sub> = 0 V, f = 1 MHz, V <sub>DS</sub> = 800 V	-	1789	-	pF
Output Capacitance	C <sub>OSS</sub>		-	139	-	
Reverse Transfer Capacitance	C <sub>RSS</sub>		-	12.5	-	

# NVXK2VR40WDT2

## ELECTRICAL CHARACTERISTICS ( $T_J = 25^\circ\text{C}$ unless otherwise stated) (continued)

Parameter	Symbol	Test Conditions	Min	Typ	Max	Unit
<b>CHARGES, CAPACITANCES &amp; GATE RESISTANCE</b>						
Total Gate Charge	$Q_{G(TOT)}$	$V_{GS} = -5/20\text{ V}, V_{DS} = 600\text{ V}, I_D = 47\text{ A}$	-	106	-	nC
Threshold Gate Charge	$Q_{G(TH)}$		-	18	-	
Gate-to-Source Charge	$Q_{GS}$		-	34	-	
Gate-to-Drain Charge	$Q_{GD}$		-	26	-	
Gate-Resistance	$R_G$	$V_{GS} = 0\text{ V}, f = 1\text{ MHz}$	-	2	-	$\Omega$

### INDUCTIVE SWITCHING CHARACTERISTICS

Turn-On Delay Time	$t_{d(ON)}$	$V_{GS} = -5/20\text{ V}, V_{DS} = 800\text{ V}, I_D = 47\text{ A}, R_G = 4.7\ \Omega,$ Inductive load	-	17	-	ns
Rise Time	$t_r$		-	20	-	
Turn-Off Delay Time	$t_{d(OFF)}$		-	30	-	
Fall Time	$t_f$		-	9	-	
Turn-On Switching Loss	$E_{ON}$		-	366	-	$\mu\text{J}$
Turn-Off Switching Loss	$E_{OFF}$		-	200	-	$\mu\text{J}$
Total Switching Loss	$E_{tot}$	-	566	-	$\mu\text{J}$	

### DRAIN-SOURCE DIODE CHARACTERISTICS

Continuous Drain-Source Diode Forward Current (Note 1)	$I_{SD}$	$V_{GS} = -5\text{ V}, T_J = 25^\circ\text{C}$	-	-	27	A
Pulsed Drain-Source Diode Forward Current (Note 2)	$I_{SDM}$	$V_{GS} = -5\text{ V}, T_J = 25^\circ\text{C}$	-	-	170	A
Forward Diode Voltage	$V_{SD}$	$V_{GS} = -5\text{ V}, I_{SD} = 17.5\text{ A}, T_J = 25^\circ\text{C}$	-	3.7	-	V
Reverse Recovery Time	$t_{RR}$	$V_{GS} = -5\text{ V}, di_S/dt = 1000\text{ A}/\mu\text{s}, I_{SD} = 17.5\text{ A}$	-	24	-	ns
Peak Reverse Recovery Current	$I_{RRM}$		-	10.4	-	A
Charge Time	$t_a$		-	12.4	-	ns
Discharge Time	$t_b$		-	11.6	-	ns
Reverse Recovery Charge	$Q_{RR}$		-	125	-	nC

Product parametric performance is indicated in the Electrical Characteristics for the listed test conditions, unless otherwise noted. Product performance may not be indicated by the Electrical Characteristics if operated under different conditions.

4. Pulse test: pulse width  $\leq 300\ \mu\text{s}$ , duty ratio  $\leq 2\%$ .

### COMPONENTS

Component	Description	Type	Quantity	Specification
NTC	10 k $\Omega$ , $\pm 3\%$ Case Size 0603	Discrete	1	B Constants $B_{25/50} = 3590$ $B_{25/85} = 3635$ $B_{25/100} = 3650 \pm 3\%$

# NVXK2VR40WDT2

## TYPICAL CHARACTERISTICS

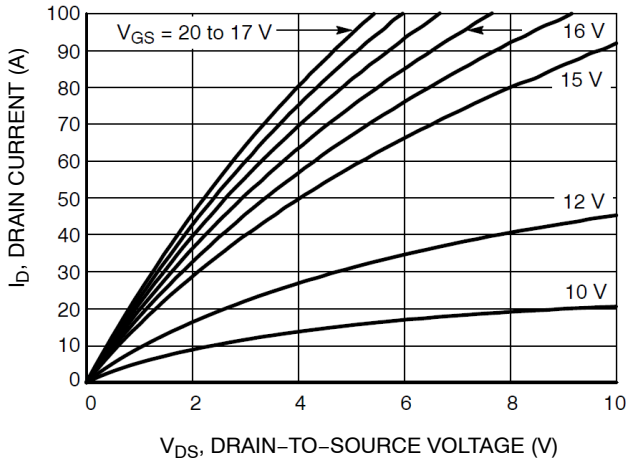

Figure 1. On-Region Characteristics

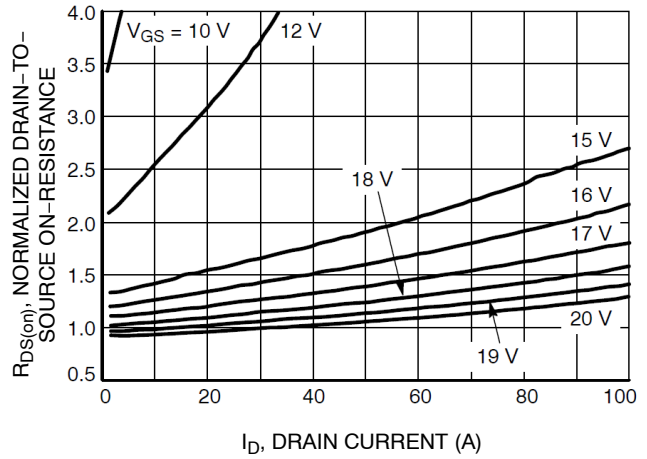

Figure 2. Normalized On-Resistance vs. Drain Current and Gate Voltage

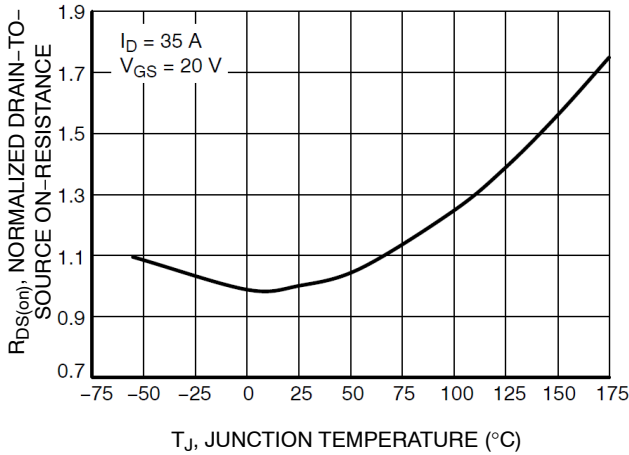

Figure 3. On-Resistance Variation with Temperature

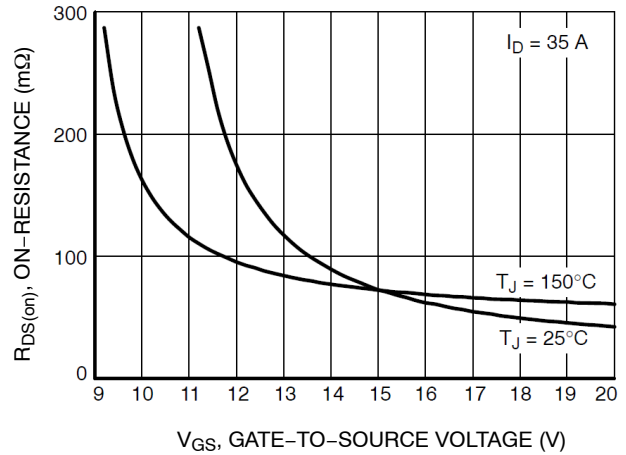

Figure 4. On-Resistance vs. Gate-to-Source Voltage

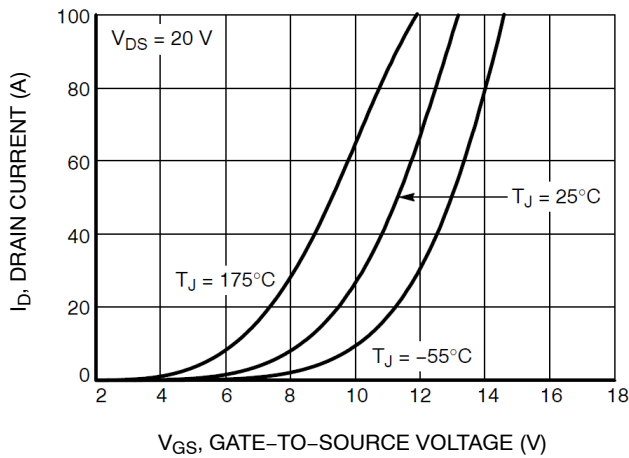

Figure 5. Transfer Characteristics

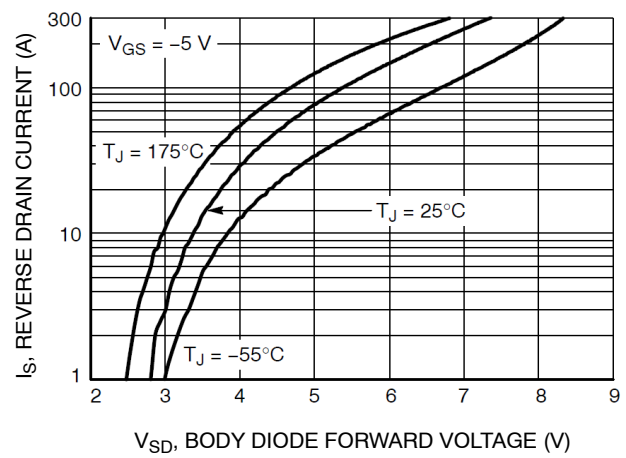

Figure 6. Diode Forward Voltage vs. Current

# NVXK2VR40WDT2

## TYPICAL CHARACTERISTICS (continued)

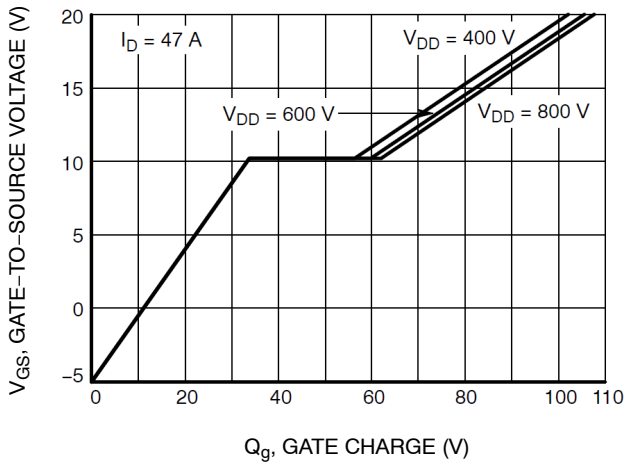

Figure 7. Gate-to-Source Voltage vs. Total Charge

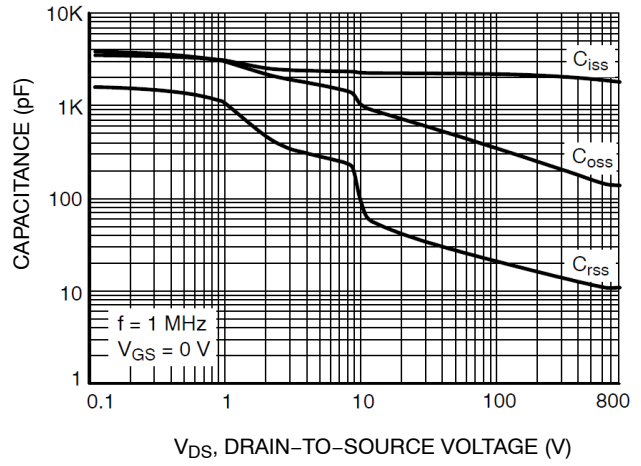

Figure 8. Capacitance vs. Drain-to-Source Voltage

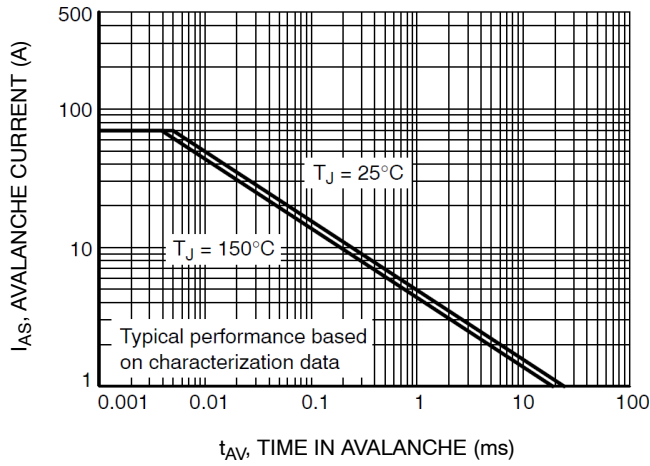

Figure 9. Unclamped Inductive Switching Capability

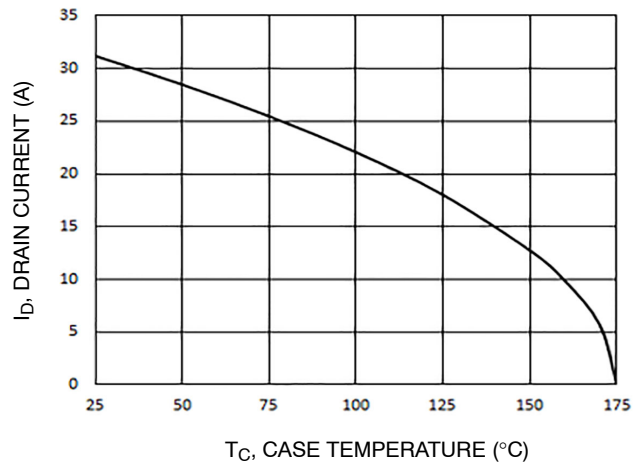

Figure 10. Maximum Continuous Drain Current vs. Case Temperature

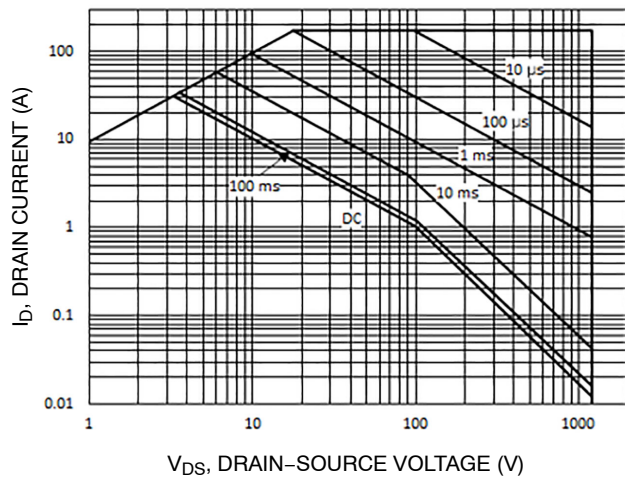

Figure 11. Safe Operating Area

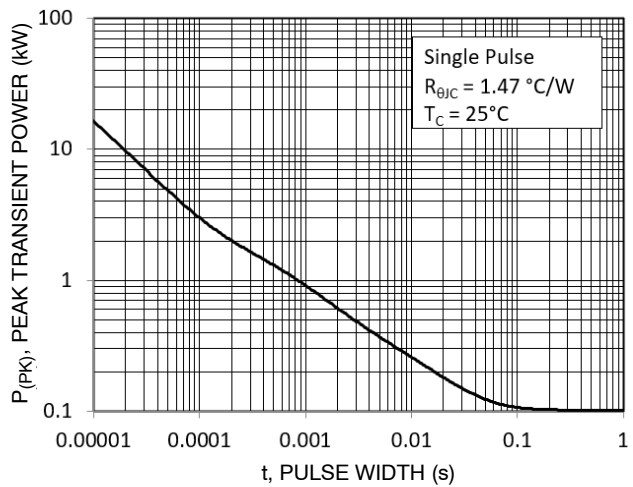

Figure 12. Single Pulse Maximum Power Dissipation

# NVXK2VR40WDT2

## TYPICAL CHARACTERISTICS (continued)

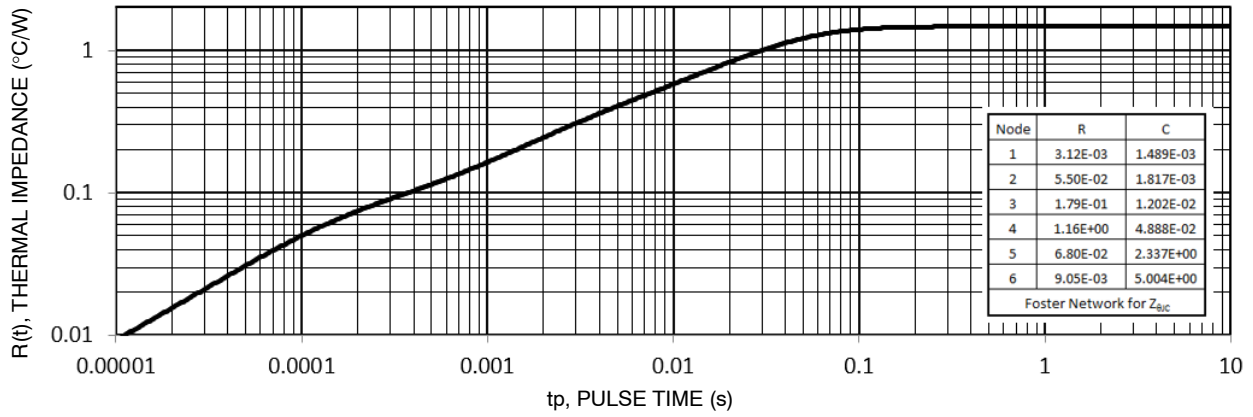
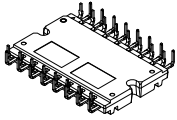
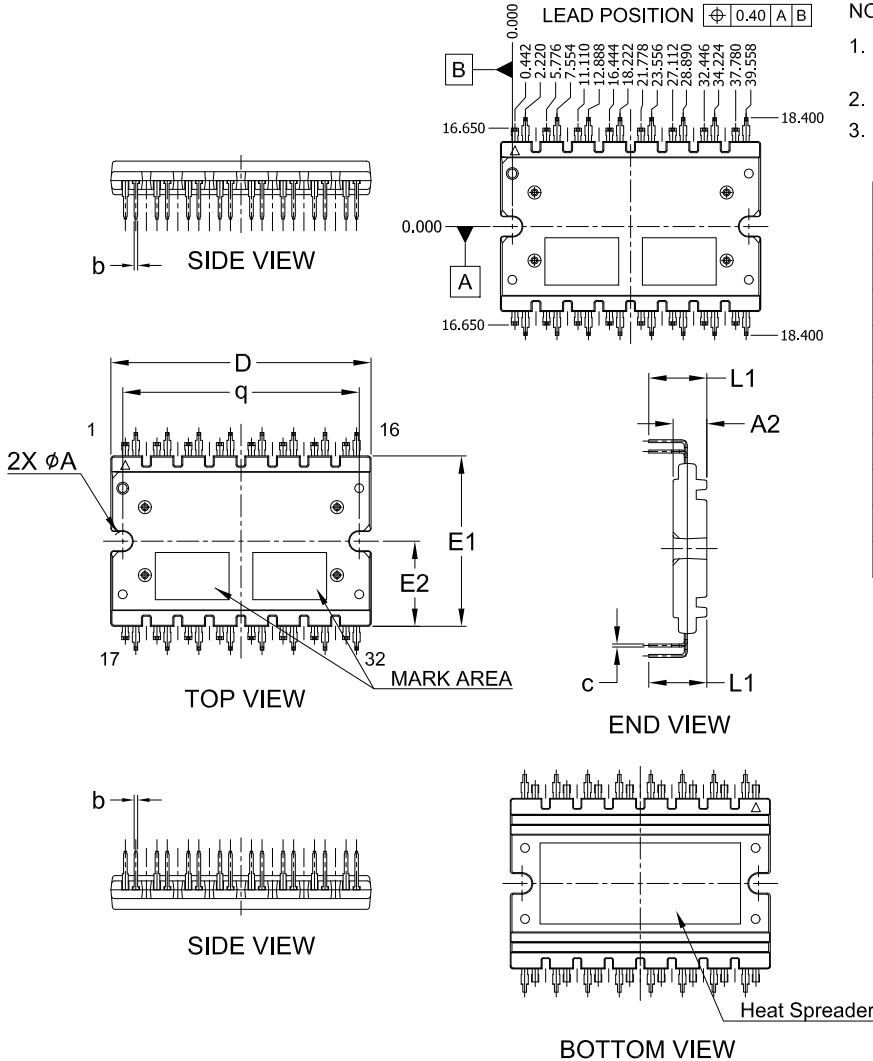

Figure 13. Thermal Response



**APM32 44.00x28.80x5.70  
CASE MODHM  
ISSUE A**

DATE 01 AUG 2023



**NOTES:**

1. DIMENSIONING AND TOLERANCING PER. ASME Y14.5M, 2009.
2. CONTROLLING DIMENSION: MILLIMETERS
3. DIMENSIONS ARE EXCLUSIVE OF BURRS, MOLD FLASH AND TIE BAR EXTRUSIONS.

DIM	MILLIMETERS		
	MIN.	NOM.	MAX.
A2	5.60	5.70	5.80
b	0.50	0.60	0.70
c	0.45	0.50	0.60
D	43.80	44.00	44.20
E1	28.60	28.80	29.00
E2	14.25	14.40	14.55
L1	9.50	9.80	10.10
q	39.85	40.00	40.15
$\phi A$	3.20	3.30	3.40

**GENERIC MARKING DIAGRAM\***

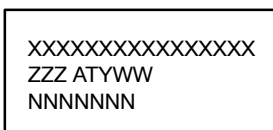

XXXX = Specific Device Code  
 ZZZ = Lot ID  
 AT = Assembly & Test Location  
 Y = Year  
 W = Work Week  
 NNN = Serial Number

\*This information is generic. Please refer to device data sheet for actual part marking. Pb-Free indicator, "G" or microdot "•", may or may not be present. Some products may not follow the Generic Marking.

<b>DOCUMENT NUMBER:</b>	<b>98AON29480H</b>	Electronic versions are uncontrolled except when accessed directly from the Document Repository. Printed versions are uncontrolled except when stamped "CONTROLLED COPY" in red.
<b>DESCRIPTION:</b>	<b>APM32 44.00x28.80x5.70</b>	<b>PAGE 1 OF 1</b>

onsemi and ONSEMI are trademarks of Semiconductor Components Industries, LLC dba onsemi or its subsidiaries in the United States and/or other countries. onsemi reserves the right to make changes without further notice to any products herein. onsemi makes no warranty, representation or guarantee regarding the suitability of its products for any particular purpose, nor does onsemi assume any liability arising out of the application or use of any product or circuit, and specifically disclaims any and all liability, including without limitation special, consequential or incidental damages. onsemi does not convey any license under its patent rights nor the rights of others.

**onsemi**, **Onsemi**, and other names, marks, and brands are registered and/or common law trademarks of Semiconductor Components Industries, LLC dba "**onsemi**" or its affiliates and/or subsidiaries in the United States and/or other countries. **onsemi** owns the rights to a number of patents, trademarks, copyrights, trade secrets, and other intellectual property. A listing of **onsemi**'s product/patent coverage may be accessed at [www.onsemi.com/site/pdf/Patent-Marking.pdf](http://www.onsemi.com/site/pdf/Patent-Marking.pdf). **onsemi** reserves the right to make changes at any time to any products or information herein, without notice. The information herein is provided "as-is" and **onsemi** makes no warranty, representation or guarantee regarding the accuracy of the information, product features, availability, functionality, or suitability of its products for any particular purpose, nor does **onsemi** assume any liability arising out of the application or use of any product or circuit, and specifically disclaims any and all liability, including without limitation special, consequential or incidental damages. Buyer is responsible for its products and applications using **onsemi** products, including compliance with all laws, regulations and safety requirements or standards, regardless of any support or applications information provided by **onsemi**. "Typical" parameters which may be provided in **onsemi** data sheets and/or specifications can and do vary in different applications and actual performance may vary over time. All operating parameters, including "Typicals" must be validated for each customer application by customer's technical experts. **onsemi** does not convey any license under any of its intellectual property rights nor the rights of others. **onsemi** products are not designed, intended, or authorized for use as a critical component in life support systems or any FDA Class 3 medical devices or medical devices with a same or similar classification in a foreign jurisdiction or any devices intended for implantation in the human body. Should Buyer purchase or use **onsemi** products for any such unintended or unauthorized application, Buyer shall indemnify and hold **onsemi** and its officers, employees, subsidiaries, affiliates, and distributors harmless against all claims, costs, damages, and expenses, and reasonable attorney fees arising out of, directly or indirectly, any claim of personal injury or death associated with such unintended or unauthorized use, even if such claim alleges that **onsemi** was negligent regarding the design or manufacture of the part. **onsemi** is an Equal Opportunity/Affirmative Action Employer. This literature is subject to all applicable copyright laws and is not for resale in any manner.

## ADDITIONAL INFORMATION

### TECHNICAL PUBLICATIONS:

Technical Library: [www.onsemi.com/design/resources/technical-documentation](http://www.onsemi.com/design/resources/technical-documentation)  
onsemi Website: [www.onsemi.com](http://www.onsemi.com)

### ONLINE SUPPORT: [www.onsemi.com/support](http://www.onsemi.com/support)

For additional information, please contact your local Sales Representative at [www.onsemi.com/support/sales](http://www.onsemi.com/support/sales)

