



Is Now Part of



ON Semiconductor®

To learn more about ON Semiconductor, please visit our website at www.onsemi.com

Please note. As part of the Fairchild Semiconductor integration, some of the Fairchild orderable part numbers will need to change in order to meet ON Semiconductor's system requirements. Since the ON Semiconductor product management systems do not have the ability to manage part nomenclature that utilizes an underscore (), the underscore () in the Fairchild part numbers will be changed to a dash (-). This document may contain device numbers with an underscore (). Please check the ON Semiconductor website to verify the updated device numbers. The most current and up-to-date ordering information can be found at www.onsemi.com. Please email any questions regarding the system integration to Fairchild_questions@onsemi.com.

ON Semiconductor and the ON Semiconductor logo are trademarks of Semiconductor Components Industries, LLC dba ON Semiconductor or its subsidiaries in the United States and/or other countries. ON Semiconductor owns the rights to a number of patents, trademarks, copyrights, trade secrets, and other intellectual property. A listing of ON Semiconductor's product/patent coverage may be accessed at www.onsemi.com/site/pdf/Patent-Marking.pdf. ON Semiconductor reserves the right to make changes without further notice to any products herein. ON Semiconductor makes no warranty, representation or guarantee regarding the suitability of its products for any particular purpose, nor does ON Semiconductor assume any liability arising out of the application or use of any product or circuit, and specifically disclaims any and all liability, including without limitation special, consequential or incidental damages. Buyer is responsible for its products and applications using ON Semiconductor products, including compliance with all laws, regulations and safety requirements or standards, regardless of any support or applications information provided by ON Semiconductor. "Typical" parameters which may be provided in ON Semiconductor data sheets and/or specifications can and do vary in different applications and actual performance may vary over time. All operating parameters, including "Typicals" must be validated for each customer application by customer's technical experts. ON Semiconductor does not convey any license under its patent rights nor the rights of others. ON Semiconductor products are not designed, intended, or authorized for use as a critical component in life support systems or any FDA Class 3 medical devices or medical devices with a same or similar classification in a foreign jurisdiction or any devices intended for implantation in the human body. Should Buyer purchase or use ON Semiconductor products for any such unintended or unauthorized application, Buyer shall indemnify and hold ON Semiconductor and its officers, employees, subsidiaries, affiliates, and distributors harmless against all claims, costs, damages, and expenses, and reasonable attorney fees arising out of, directly or indirectly, any claim of personal injury or death associated with such unintended or unauthorized use, even if such claim alleges that ON Semiconductor was negligent regarding the design or manufacture of the part. ON Semiconductor is an Equal Opportunity/Affirmative Action Employer. This literature is subject to all applicable copyright laws and is not for resale in any manner.

74LVT373, 74LVTH373

Low Voltage Octal Transparent Latch with 3-STATE Outputs

Features

- Input and output interface capability to systems at 5V V_{CC}
- Bushold data inputs eliminate the need for external pull-up resistors to hold unused inputs (74LVTH373), also available without bushold feature (74LVT373)
- Live insertion/extraction permitted
- Power Up/Down high impedance provides glitch-free bus loading
- Outputs source/sink $-32\text{ mA}/+64\text{ mA}$
- Functionally compatible with the 74 series 373
- ESD performance:
 - Human-body model > 2000V
 - Machine model > 200V
 - Charged-device model > 1000V

General Description

The LVT373 and LVTH373 consist of eight latches with 3-STATE outputs for bus organized system applications. The latches appear transparent to the data when Latch Enable (LE) is HIGH. When LE is LOW, the data satisfying the input timing requirements is latched. Data appears on the bus when the Output Enable (\overline{OE}) is LOW. When \overline{OE} is HIGH, the bus output is in a high impedance state.

The LVT373 data inputs include bushold, eliminating the need for external pull-up resistors to hold unused inputs.

These octal latches are designed for low-voltage (3.3V) V_{CC} applications, but with the capability to provide a TTL interface to a 5V environment. The LVT373 and LVTH373 are fabricated with an advanced BiCMOS technology to achieve high speed operation similar to 5V ABT while maintaining low power dissipation.

Ordering Information

Order Number	Package Number	Package Description
74LVT373WM	M20B	20-Lead Small Outline Integrated Circuit (SOIC), JEDEC MS-013, 0.300" Wide
74LVT373SJ	M20D	20-Lead Small Outline Package (SOP), EIAJ TYPE II, 5.3mm Wide
74LVT373MTC	MTC20	20-Lead Thin Shrink Small Outline Package (TSSOP), JEDEC MO-153, 4.4mm Wide
74LVTH373WM	M20B	20-Lead Small Outline Integrated Circuit (SOIC), JEDEC MS-013, 0.300" Wide
74LVTH373SJ	M20D	20-Lead Small Outline Package (SOP), EIAJ TYPE II, 5.3mm Wide
74LVTH373MTC	MTC20	20-Lead Thin Shrink Small Outline Package (TSSOP), JEDEC MO-153, 4.4mm Wide

Device also available in Tape and Reel. Specify by appending suffix letter "X" to the ordering number.

 All packages are lead free per JEDEC: J-STD-020B standard.

Connection Diagram

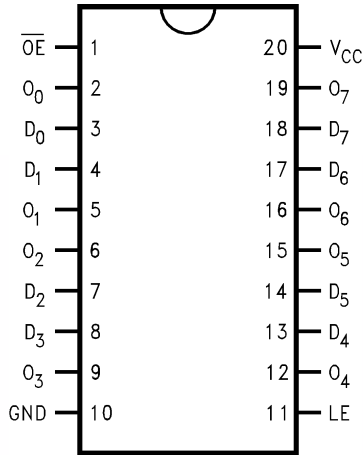

Logic Symbols

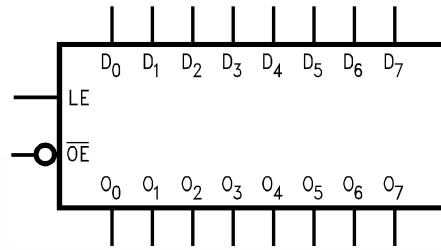

IEEE/IEC

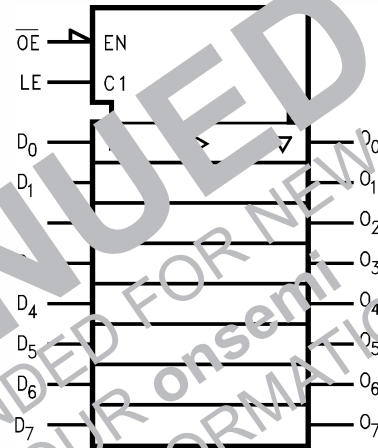

Pin Description

Pin Names	Description
D ₀ –D ₇	Data Inputs
LE	Latch Enable Input
\overline{OE}	Output Enable Input
O ₀ –O ₇	3-STATE Latch Outputs

Functional Description

The LVT373 and LVTH373 contain eight D-type latches with 3-STATE standard outputs. When the Latch Enable (LE) input is HIGH, data on the D_n inputs enters the latches. In this condition the latches are transparent, i.e., a latch output will change state each time its D input changes. When LE is LOW, the latches store the information that was present on the D inputs a setup time preceding the HIGH-to-LOW transition of LE. The 3-STATE standard outputs are controlled by the Output Enable (\overline{OE}) input. When \overline{OE} is LOW, the standard outputs are in the 2-state mode. When \overline{OE} is HIGH, the standard outputs are in the high impedance mode but this does not interfere with entering new data into the latches.

Truth Table

Inputs			Outputs
LE	\overline{OE}	D _n	O _n
X	H	X	Z
H	L	L	L
H	L	H	H
L	L	X	O ₀

H = HIGH Voltage Level

L = LOW Voltage Level

Z = High Impedance

X = Immaterial

O₀ = Previous O₀ before HIGH-to-LOW transition of Latch Enable

Logic Diagram

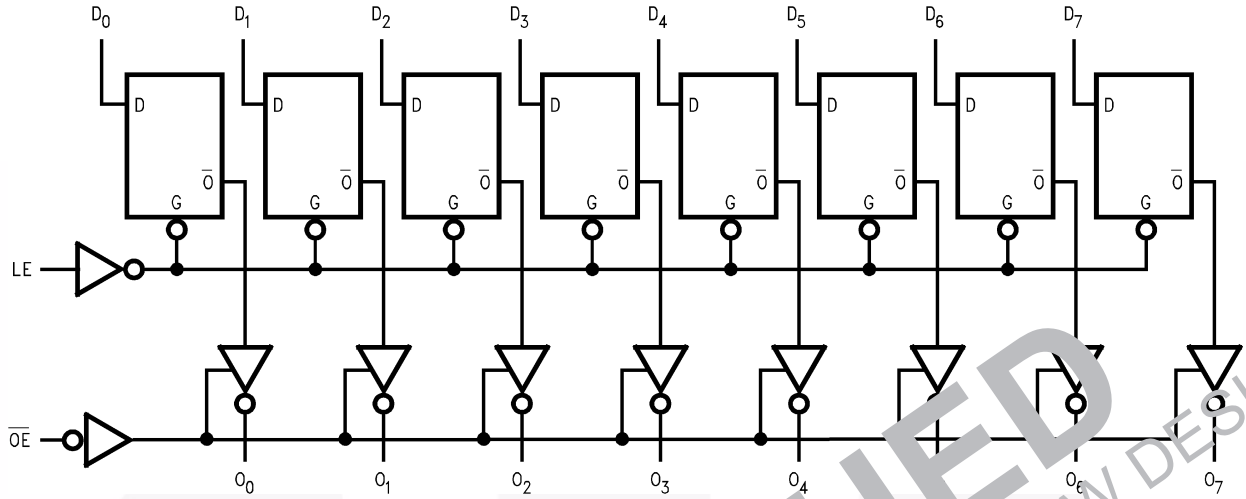

Please note that this diagram is provided only for the understanding of logic operations and should not be used to estimate propagation delays.

DISCONTINUED
 THIS DEVICE IS NOT RECOMMENDED FOR NEW DESIGN
 PLEASE CONTACT YOUR onsemi
 REPRESENTATIVE FOR INFORMATION

Absolute Maximum Ratings

Stresses exceeding the absolute maximum ratings may damage the device. The device may not function or be operable above the recommended operating conditions and stressing the parts to these levels is not recommended. In addition, extended exposure to stresses above the recommended operating conditions may affect device reliability. The absolute maximum ratings are stress ratings only.

Symbol	Parameter	Rating
V_{CC}	Supply Voltage	-0.5V to +4.6V
V_I	DC Input Voltage	-0.5V to +7.0V
V_O	DC Output Voltage Output in 3-STATE	-0.5V to +7.0V
	Output in HIGH or LOW State ⁽¹⁾	-0.5V to +7.0V
I_{IK}	DC Input Diode Current, $V_I < GND$	-50mA
I_{OK}	DC Output Diode Current, $V_O < GND$	-50mA
I_O	DC Output Current, $V_O > V_{CC}$ Output at HIGH State	64mA
	Output at LOW State	128mA
I_{CC}	DC Supply Current per Supply Pin	±64mA
I_{GND}	DC Ground Current per Ground Pin	±128mA
T_{STG}	Storage Temperature	-65°C to +150°C

Note:

- I_O Absolute Maximum Rating must be observed.

Recommended Operating Conditions

The Recommended Operating Conditions table defines the conditions for actual device operation. Recommended operating conditions are specified to ensure optimal performance to the datasheet specifications. Fairchild does not recommend exceeding them or designing to absolute maximum ratings.

Symbol	Parameter	Min	Max	Units
V_{CC}	Supply Voltage	2.7	3.6	V
V_I	Input Voltage	0	5.5	V
I_{OH}	HIGH-Level Output Current		-32	mA
I_{OL}	LOW-Level Output Current		64	mA
T_A	Free-Air Operating Temperature	-40	85	°C
$\Delta t / \Delta V$	Input Edge Rate, $V_{IN} = 0.8V-2.0V$, $V_{CC} = 3.0V$	0	10	ns/V

DC Electrical Characteristics

Symbol	Parameter	V _{CC} (V)	Conditions	T _A = -40°C to +85°C			Units	
				Min.	Typ. ⁽²⁾	Max.		
V _{IK}	Input Clamp Diode Voltage	2.7	I _I = -18mA			-1.2	V	
V _{IH}	Input HIGH Voltage	2.7-3.6	V _O ≤ 0.1V or	2.0			V	
V _{IL}	Input LOW Voltage	2.7-3.6	V _O ≥ V _{CC} - 0.1V			0.8	V	
V _{OH}	Output HIGH Voltage	2.7-3.6	I _{OH} = -100μA	V _{CC} -0.2			V	
		2.7	I _{OH} = -8mA	2.4				
		3.0	I _{OH} = -32mA	2.0				
V _{OL}	Output LOW Voltage	2.7	I _{OL} = 100μA			0.2	V	
			I _{OL} = 24mA			0.5		
		3.0	I _{OL} = 16mA			0.4		
			I _{OL} = 32mA			0.5		
			I _{OL} = 64mA			0.55		
I _{I(HOLD)} ⁽³⁾	Bushold Input Minimum Drive	3.0	V _I = 0.8V	75			μA	
			V _I = 2.0V	-75				
I _{I(OD)} ⁽³⁾	Bushold Input Over-Drive Current to Change State	3.0	⁽⁴⁾	500			μA	
I _I	Input Current	3.6	V _I = 5.5V			10	μA	
		Control Pins	3.3	V _I = V or V _{CC}			±1	
			Data Pins	3.3	V _I = 0V			-5
				3.3	V _I = V _{CC}			1
I _{OFF}	Power Off Leakage Current	3.6	V _I ≤ V _I or V _O ≤ 5.5V			±100	μA	
I _{PU/PD}	Power up/down 3-STATE Output Current	3.6	V _O = 0.5V to 3.0V, V _I = GND or V _{CC}			±100	μA	
I _{OZL}	3-STATE Output Leakage Current	3.6	V _O = 0.5V			-5	μA	
I _{OZ0}	3-STATE Output Leakage Current	3.6	V _O = 3.0V			5	μA	
I _{OZH+}	3-STATE Output Leakage Current	3.6	V _{CC} < V _O ≤ 5.5V			10	μA	
I _{CCH}	Power Supply Current	3.6	Outputs HIGH			0.19	mA	
I _{ocL}	Power Supply Current	3.6	Outputs LOW			5	mA	
I _{ocZ}	Power Supply Current	3.6	Outputs Disabled			0.19	mA	
I _{ocZ+}	Power Supply Current	3.6	V _{CC} ≤ V _O ≤ 5.5V, Outputs Disabled			0.19	mA	
ΔI _{CC}	Increase in Power Supply Current ⁽⁶⁾	3.6	One Input at V _{CC} - 0.6V, Other Inputs at V _{CC} or GND			0.2	mA	

Notes:

- All typical values are at V_{CC} = 3.3V, T_A = 25°C.
- Applies to bushold versions only (74LVTH373).
- An external driver must source at least the specified current to switch from LOW-to-HIGH.
- An external driver must sink at least the specified current to switch from HIGH-to-LOW.
- This is the increase in supply current for each input that is at the specified voltage level rather than V_{CC} or GND.

Dynamic Switching Characteristics⁽⁷⁾

Symbol	Parameter	V _{CC} (V)	Conditions	T _A = 25°C			Units
			C _L = 50pF, R _L = 500Ω	Min.	Typ.	Max.	
V _{OLP}	Quiet Output Maximum Dynamic V _{OL}	3.3	⁽⁸⁾		0.8		V
V _{OLV}	Quiet Output Minimum Dynamic V _{OL}	3.3	⁽⁸⁾		-0.8		V

Notes:

7. Characterized in SOIC package. Guaranteed parameter, but not tested.
 8. Max number of outputs defined as (n). n-1 data inputs are driven 0V to 3V. Output under test held LOW.

AC Electrical Characteristics

Symbol	Parameter	T _A = -40°C to +125°C, C _L = 50pF, R _L = 500Ω					Units
		V _{CC} = 3.3V (0.3)			V _{CC} = 2.7V		
		Min.	Typ. ⁽⁹⁾	Max.	Min.	Max.	
t _{PHL}	Propagation Delay, D _n to O _n	1.5		4.5	1.5	5.0	ns
t _{PLH}				4.5	1.5	4.9	
t _{PHL}	Propagation Delay, LE to O _n	1.7		4.5	1.7	4.9	ns
t _{PLH}		1.7		4.5	1.7	5.0	
t _{PZL}	Output Enable Time	1.3		4.8	1.3	5.9	ns
t _{PZH}		1.3		4.8	1.3	5.5	
t _{PLZ}	Output Disable Time	1.9		4.6	1.9	4.9	ns
t _{PHZ}		1.9		4.6	1.9	4.9	
t _W	LE Pulse Width	3.0			3.0		ns
t _S	Setup Time, D _n to LE	1.1			1.0		ns
t _H	Hold Time, D _n to LE	1.4			1.4		ns

Note:

9. Typical values are at V_{CC} = 3.3V, T_A = 25°C.

Capacitance⁽¹⁰⁾

Symbol	Parameter	Conditions	Typical	Units
C _{IN}	Input Capacitance	V _{CC} = OPEN, V _I = 0V or V _{CC}	3	pF
C _{OUT}	Output Capacitance	V _{CC} = 3.0V, V _O = 0V or V _{CC}	5	pF

Note:

10. Capacitance is measured at frequency f = 1MHz, per MIL-STD-883, Method 3012.

Physical Dimensions

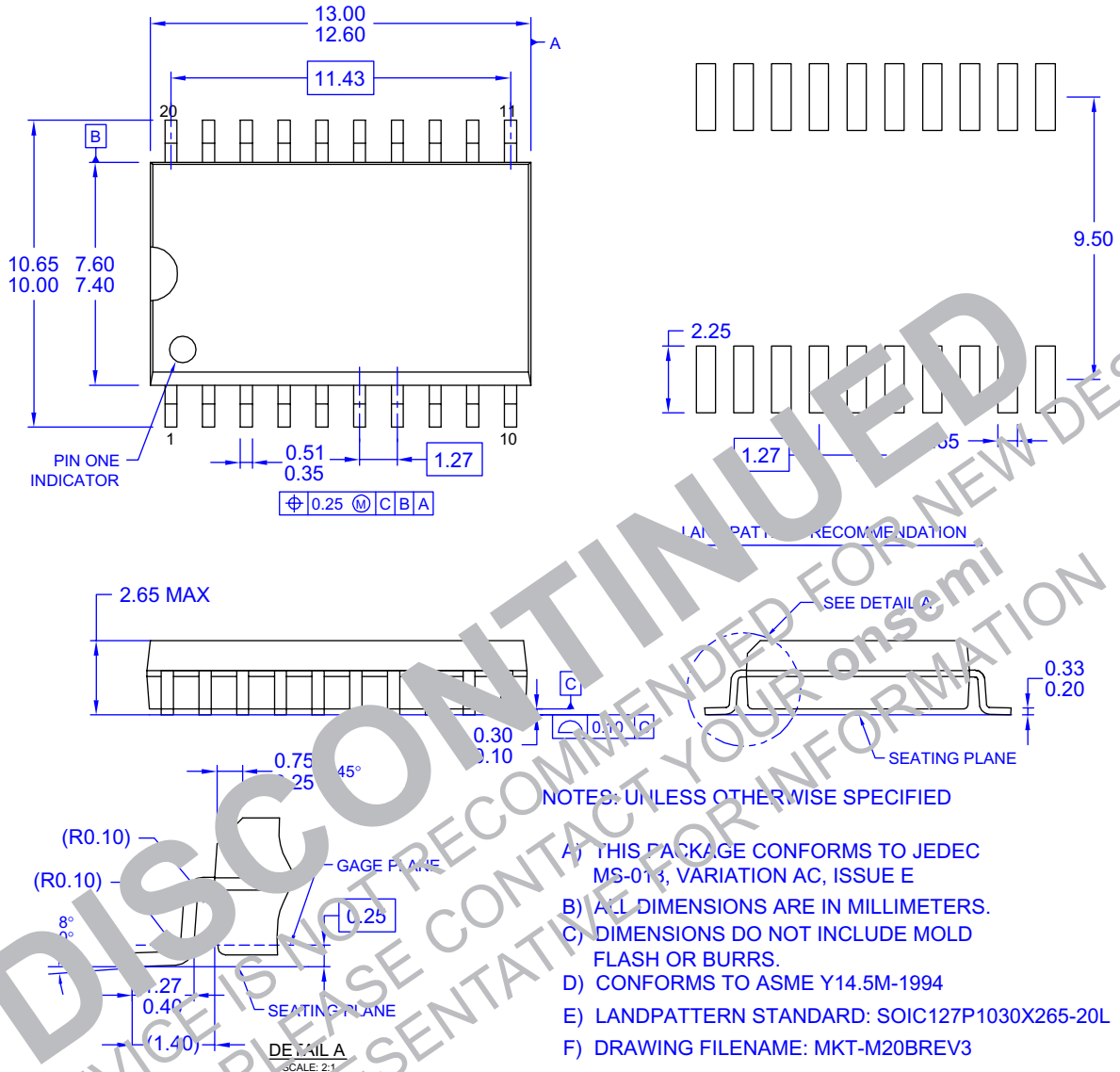

Figure 1. 20-Lead Small Outline Integrated Circuit (SOIC), JEDEC MS-013, 0.300" Wide

Package drawings are provided as a service to customers considering Fairchild components. Drawings may change in any manner without notice. Please note the revision and/or date on the drawing and contact a Fairchild Semiconductor representative to verify or obtain the most recent revision. Package specifications do not expand the terms of Fairchild's worldwide terms and conditions, specifically the warranty therein, which covers Fairchild products.

Always visit Fairchild Semiconductor's online packaging area for the most recent package drawings:

<http://www.fairchildsemi.com/packaging/>

Physical Dimensions (Continued)

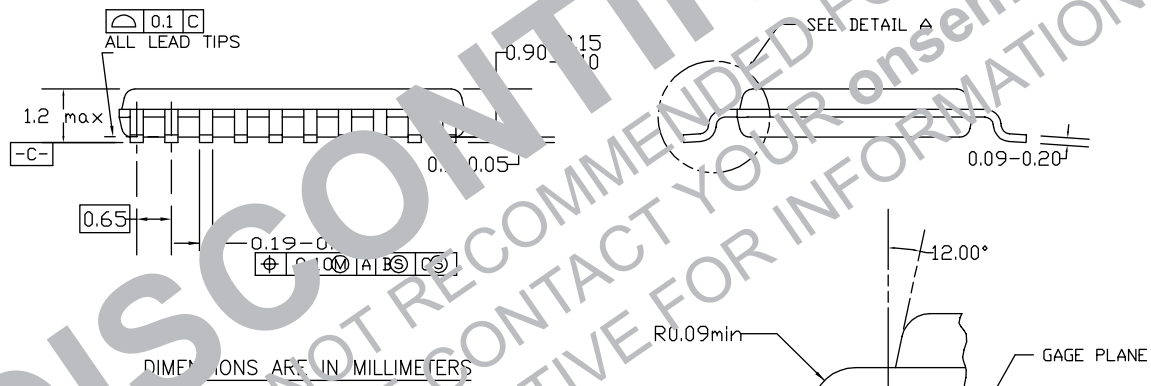
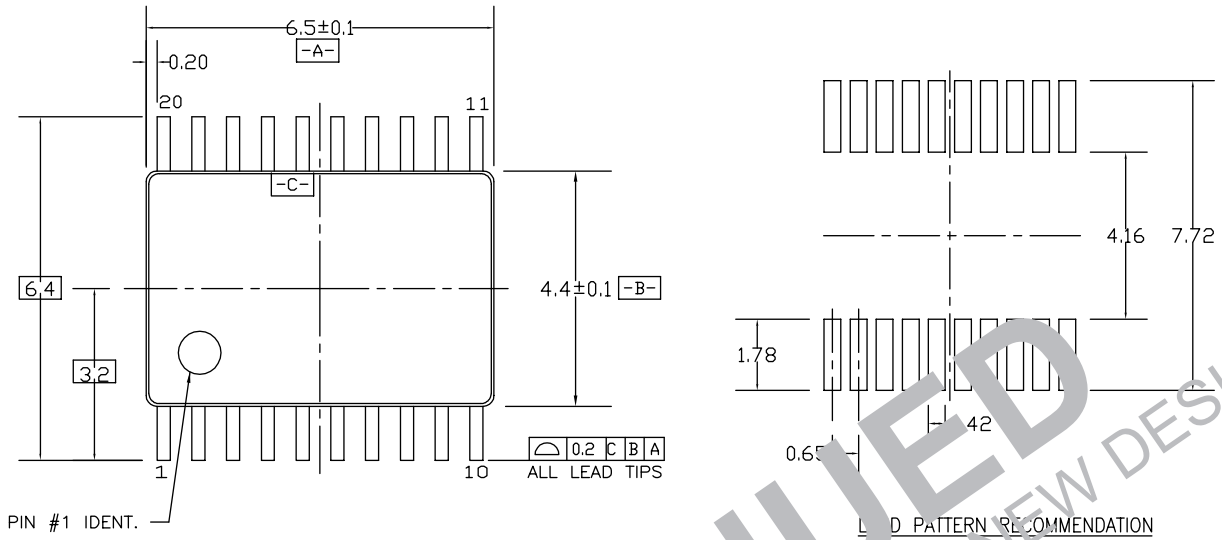

DIMENSIONS ARE IN MILLIMETERS

NOTES:

- A. CONFORMS TO JEDEC REGISTRATION MO-153 VARIATION AC, REF. NOTE 6, DATE 7/93.
- B. DIMENSIONS ARE IN MILLIMETERS.
- C. DIMENSIONS ARE EXCLUSIVE OF BURRS, MOLDS FLASH, AND TIE BAR EXTRUSIONS.
- D. DIMENSIONS AND TOLERANCES PER ANSI Y14.5M, 1982.

MTC20REV D1

Figure 3. 20-Lead Thin Shrink Small Outline Package (TSSOP), JEDEC MO-153, 4.4mm Wide

Package drawings are provided as a service to customers considering Fairchild components. Drawings may change in any manner without notice. Please note the revision and/or date on the drawing and contact a Fairchild Semiconductor representative to verify or obtain the most recent revision. Package specifications do not expand the terms of Fairchild's worldwide terms and conditions, specifically the warranty therein, which covers Fairchild products.



Always visit Fairchild Semiconductor's online packaging area for the most recent package drawings:

<http://www.fairchildsemi.com/packaging/>



TRADEMARKS

The following includes registered and unregistered trademarks and service marks, owned by Fairchild Semiconductor and/or its global subsidiaries, and is not intended to be an exhaustive list of all such trademarks.

- | | | | |
|---|--|--|----------------------------------|
| ACEx [®] | FPS [™] | PDP-SPM [™] | SupreMOS [™] |
| Build it Now [™] | FRFET [®] | Power220 [®] | SyncFET [™] |
| CorePLUS [™] | Global Power Resource SM | POWEREDGE [®] | SYSTEM [®] |
| CROSSVOLT [™] | Green FPS [™] | Power-SPM [™] | GENERAL |
| CTL [™] | Green FPS [™] e-Series [™] | PowerTrench [®] | The Power Franchise [®] |
| Current Transfer Logic [™] | GTO [™] | Programmable Active Droop [™] | the |
| EcoSPARK [®] | i-Lo [™] | QFET [®] | power |
| EZSWITCH [™] * | IntelliMAX [™] | QS [™] | Franchise |
|  | ISOPLANAR [™] | QT Optoelectronics [™] | TinyBoost [™] |
|  | MegaBuck [™] | Quiet Series [™] | TinyBuck [™] |
| Fairchild [®] | MICROCOUPLER [™] | RapidConfigure [™] | TinyLo [™] |
| Fairchild Semiconductor [®] | MicroFET [™] | SMART START [™] | NYPTO [™] |
| FACT Quiet Series [™] | MicroPak [™] | SPM [®] | TinyPower [™] |
| FACT [®] | MillerDrive [™] | STEALTH [™] | TinyPWM [™] |
| FAST [®] | Motion-SPM [™] | Super [™] | TinyWire [™] |
| FastvCore [™] | OPTOLOGIC [®] | SO-8 | UerDes [™] |
| FlashWriter [®] | OPTOPLANAR [®] | Sup [™] | UHC [®] |
| | | Sup [™] | Ultra FRFET [™] |
| | | | Ur [™] |
| | | | /CX [™] |

* EZSWITCH[™] and FlashWriter[®] are trademarks of System General Corporation, used under license by Fairchild Semiconductor.

DISCLAIMER

FAIRCHILD SEMICONDUCTOR RESERVES THE RIGHT TO MAKE CHANGES WITHOUT FURTHER NOTICE TO ANY PRODUCTS HEREIN TO IMPROVE RELIABILITY, FUNCTION, OR DESIGN. FAIRCHILD DOES NOT ASSUME ANY LIABILITY ARISING OUT OF THE APPLICATION OR USE OF ANY PRODUCT OR CIRCUIT DESCRIBED HEREIN; NEITHER DOES IT CONVEY ANY LICENSE UNDER ITS PATENT RIGHTS, NOR THE TERMS OF OTHERS. THESE SPECIFICATIONS DO NOT EXPAND THE TERMS OF FAIRCHILD'S WORLDWIDE TERMS AND CONDITIONS, SPECIFICALLY THE WARRANTY THEREIN, WHICH COVERS THESE PRODUCTS.

LIFE SUPPORT POLICY

FAIRCHILD PRODUCTS ARE NOT AUTHORIZED FOR USE AS CRITICAL COMPONENTS IN LIFE SUPPORT DEVICES OR SYSTEMS WITHOUT THE EXPRESS WRITTEN APPROVAL OF FAIRCHILD SEMICONDUCTOR CORPORATION.

used herein:

- Life support devices or systems are devices or systems which (a) are intended for surgical implant into the body or (b) support or sustain life, and (c) whose failure to perform when properly used in accordance with instructions for use provided in the labeling, can be reasonably expected to result in a significant injury of the user.
- A critical component in any component of a life support device, or system whose failure to perform can be reasonably expected to cause the failure of the life support device or system, or to affect its safety or effectiveness.

PRODUCT STATUS DEFINITIONS

Definition of Terms

Datasheet Identification	Product Status	Definition
Advance Information	Formative or In Design	This datasheet contains the design specifications for product development. Specifications may change in any manner without notice.
Preliminary	First Production	This datasheet contains preliminary data; supplementary data will be published at a later date. Fairchild Semiconductor reserves the right to make changes at any time without notice to improve design.
No Identification Needed	Full Production	This datasheet contains final specifications. Fairchild Semiconductor reserves the right to make changes at any time without notice to improve the design.
Obsolete	Not In Production	This datasheet contains specifications on a product that has been discontinued by Fairchild Semiconductor. The datasheet is printed for reference information only.

Rev. 133

DISCONTINUED
THIS DEVICE IS NOT RECOMMENDED FOR NEW DESIGN
PLEASE CONTACT YOUR onsemi
REPRESENTATIVE FOR INFORMATION

ON Semiconductor and  are trademarks of Semiconductor Components Industries, LLC dba ON Semiconductor or its subsidiaries in the United States and/or other countries. ON Semiconductor owns the rights to a number of patents, trademarks, copyrights, trade secrets, and other intellectual property. A listing of ON Semiconductor's product/patent coverage may be accessed at www.onsemi.com/site/pdf/Patent-Marking.pdf. ON Semiconductor reserves the right to make changes without further notice to any products herein. ON Semiconductor makes no warranty, representation or guarantee regarding the suitability of its products for any particular purpose, nor does ON Semiconductor assume any liability arising out of the application or use of any product or circuit, and specifically disclaims any and all liability, including without limitation special, consequential or incidental damages. Buyer is responsible for its products and applications using ON Semiconductor products, including compliance with all laws, regulations and safety requirements or standards, regardless of any support or applications information provided by ON Semiconductor. "Typical" parameters which may be provided in ON Semiconductor data sheets and/or specifications can and do vary in different applications and actual performance may vary over time. All operating parameters, including "Typicals" must be validated for each customer application by customer's technical experts. ON Semiconductor does not convey any license under its patent rights nor the rights of others. ON Semiconductor products are not designed, intended, or authorized for use as a critical component in life support systems or any FDA Class 3 medical devices or medical devices with a same or similar classification in a foreign jurisdiction or any devices intended for implantation in the human body. Should Buyer purchase or use ON Semiconductor products for any such unintended or unauthorized application, Buyer shall indemnify and hold ON Semiconductor and its officers, employees, subsidiaries, affiliates, and distributors harmless against all claims, costs, damages, and expenses, and reasonable attorney fees arising out of, directly or indirectly, any claim of personal injury or death associated with such unintended or unauthorized use, even if such claim alleges that ON Semiconductor was negligent regarding the design or manufacture of the part. ON Semiconductor is an Equal Opportunity/Affirmative Action Employer. This literature is subject to all applicable copyright laws and is not for resale in any manner.

PUBLICATION ORDERING INFORMATION

LITERATURE FULFILLMENT:

Literature Distribution Center for ON Semiconductor
19521 E. 32nd Pkwy, Aurora, Colorado 80011 USA
Phone: 303-675-2175 or 800-344-3860 Toll Free USA/Canada
Fax: 303-675-2176 or 800-344-3867 Toll Free USA/Canada
Email: orderlit@onsemi.com

N. American Technical Support: 800-282-9855 Toll Free
USA/Canada
Europe, Middle East and Africa Technical Support:
Phone: 421 33 790 2910
Japan Customer Focus Center
Phone: 81-3-5817-1050

ON Semiconductor Website: www.onsemi.com
Order Literature: <http://www.onsemi.com/orderlit>
For additional information, please contact your local
Sales Representative