

Bipolar Transistor

(-)50 V, (-)7 A, Low VCE(sat), (PNP) NPN
Single PCP

2SA2016, 2SC5569

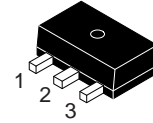

SOT-89 / PCP-1
CASE 419AU

Features

- Adoption of FBET and MBIT Processes
- Low Collector-to-Emitter Saturation Voltage
- Ultrasmall Package Facilitates Miniaturization in End Products
- High Allowable Power Dissipation
- Large Current Capacity
- High-speed Switching

Applications

- Relay Drivers, Lamp Drivers, Motor Drivers, Flash

Specifications

(): 2SA2016

ABSOLUTE MAXIMUM RATINGS (T_A = 25°C)

Parameter	Symbol	Conditions	Ratings	Unit
Collector-to-Base Voltage	V _{CBO}		(-50) 100	V
Collector-to-Emitter Voltage	V _{CES}		(-50) 100	V
Collector-to-Emitter Voltage	V _{CEO}		(-)50	V
Emitter-to-Base Voltage	V _{EBO}		(-)6	V
Collector Current	I _C		(-)7	A
Collector Current (Pulse)	I _{CP}		(-)10	A
Base Current	I _B		(-)1.2	A
Collector Dissipation	P _C	When mounted on ceramic substrate (250 mm ² x 0.8 mm)	1.3	W
		T _c = 25°C	3.5	W
Junction Temperature	T _j		150	°C
Storage Temperature	T _{stg}		-55 to +150	°C

Stresses exceeding those listed in the Maximum Ratings table may damage the device. If any of these limits are exceeded, device functionality should not be assumed, damage may occur and reliability may be affected.

MARKING DIAGRAM

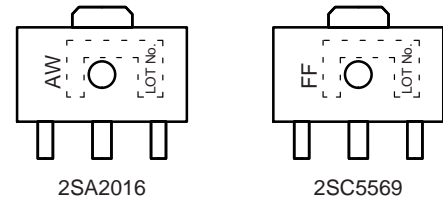

2SA2016

2SC5569

ELECTRICAL CONNECTION

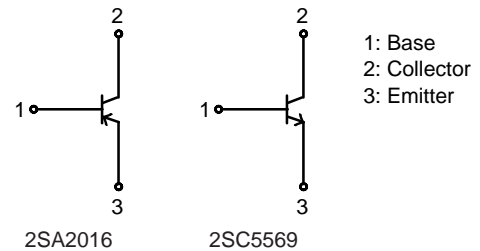

- 1: Base
2: Collector
3: Emitter

2SA2016

2SC5569

ORDERING INFORMATION

Device	Package Type (JEITA, JEDEC)	Shipping†
2SA2016-TD-E	PCP (Pb-Free)	1000 / Tape & Reel
2SC5569-TD-E		

†For information on tape and reel specifications, including part orientation and tape sizes, please refer to our Tape and Reel Packaging Specifications Brochure, [BRD8011/D](#).

ELECTRICAL CHARACTERISTICS (T_A = 25°C)

Parameter	Symbol	Conditions	Ratings			Unit
			Min	Typ	Max	
Collector Cutoff Current	I _{CBO}	V _{CB} = (-)40 V, I _E = 0 A	-	-	(-)0.1	μA
Emitter Cutoff Current	I _{EBO}	V _{EB} = (-)4 V, I _C = 0 A	-	-	(-)0.1	μA
DC Current Gain	h _{FE}	V _{CE} = (-)2 V, I _C = (-)500 mA	200	-	560	
Gain-Bandwidth Product	f _T	V _{CE} = (-)10 V, I _C = (-)500 mA	-	(290) 330	-	MHz
Output Capacitance	C _{ob}	V _{CB} = (-)10 V, f = 1 MHz	-	(50) 28	-	pF
Collector-to-Emitter Saturation Voltage	V _{CE(sat)1}	I _C = (-)3.5 A, I _B = (-)175 mA	-	(-230) 160	(-390) 240	mV
	V _{CE(sat)2}	I _C = (-)2 A, I _B = (-)40 mA	-	(-240) 110	(-400) 170	mV
Base-to-Emitter Saturation Voltage	V _{BE(sat)}	I _C = (-)2 A, I _B = (-)40 mA	-	(-)0.83	(-)1.2	V
Collector-to-Base Breakdown Voltage	V _{(BR)CBO}	I _C = (-)10 μA, I _E = 0 A	(-50) 100	-	-	V
Collector-to-Emitter Breakdown Voltage	V _{(BR)CES}	I _C = (-)100 μA, R _{BE} = 0 Ω	(-50) 100	-	-	V
Collector-to-Emitter Breakdown Voltage	V _{(BR)CEO}	I _C = (-)1 mA, R _{BE} = ∞	(-)50	-	-	V
Emitter-to-Base Breakdown Voltage	V _{(BR)EBO}	I _E = (-)10 μA, I _C = 0 A	(-)6	-	-	V
Turn-On Time	t _{on}	See specified Test Circuit.	-	(40) 30	-	ns
Storage Time	t _{stg}		-	(225) 420	-	ns
Fall Time	t _f		-	25	-	ns

Product parametric performance is indicated in the Electrical Characteristics for the listed test conditions, unless otherwise noted. Product performance may not be indicated by the Electrical Characteristics if operated under different conditions.

Switching Time Test Circuit

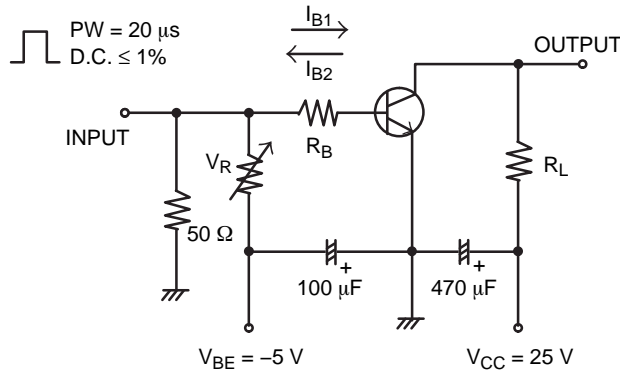

I_C = 20I_{B1} = -20I_{B2} = 2.5 A
 For PNP, the polarity is reversed.

Figure 1. Switching Time Test Circuit

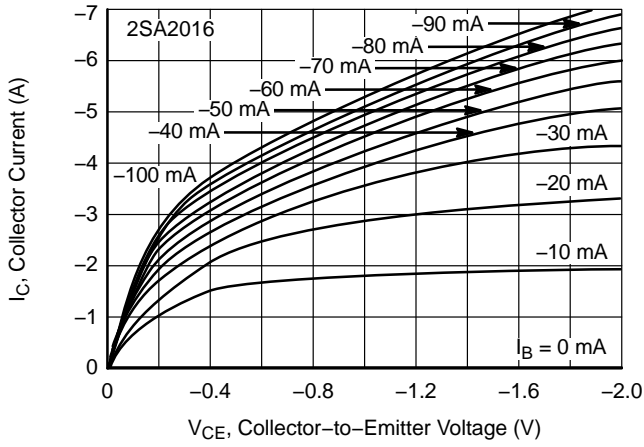

Figure 2. $I_C - V_{CE}$

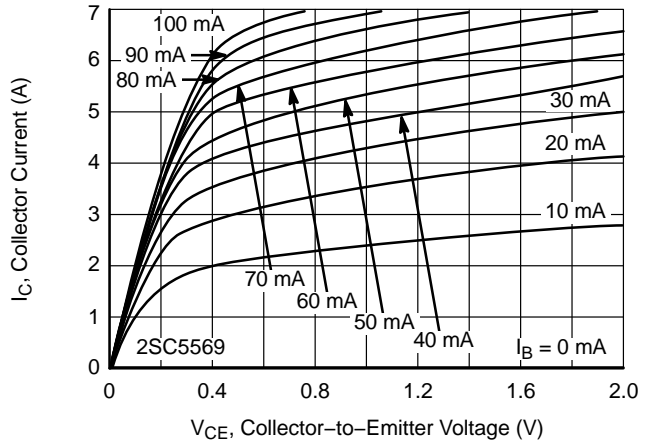

Figure 3. $I_C - V_{CE}$

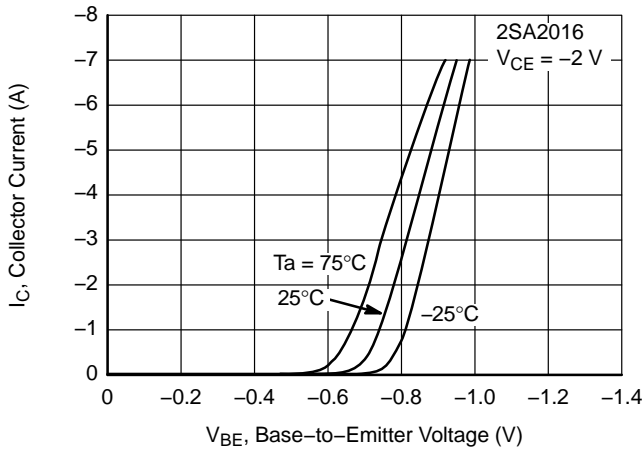

Figure 4. $I_C - V_{BE}$

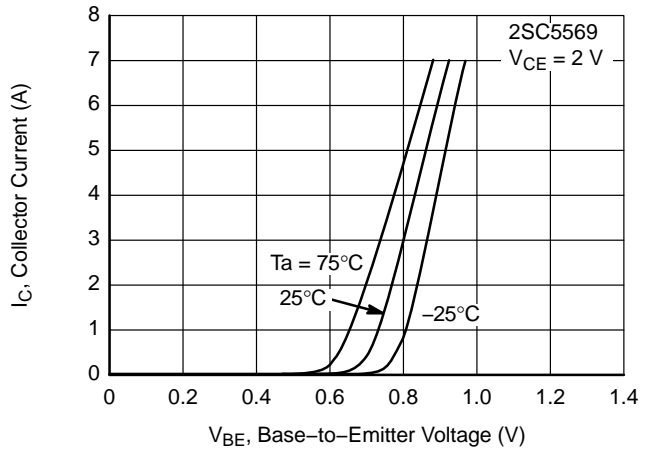

Figure 5. $I_C - V_{BE}$

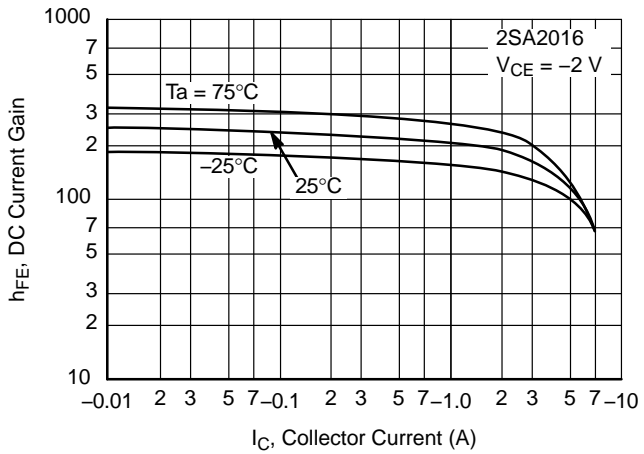

Figure 6. $h_{FE} - I_C$

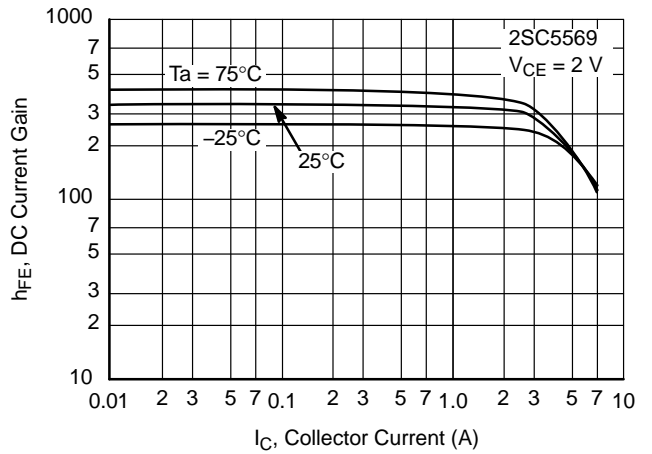

Figure 7. $h_{FE} - I_C$

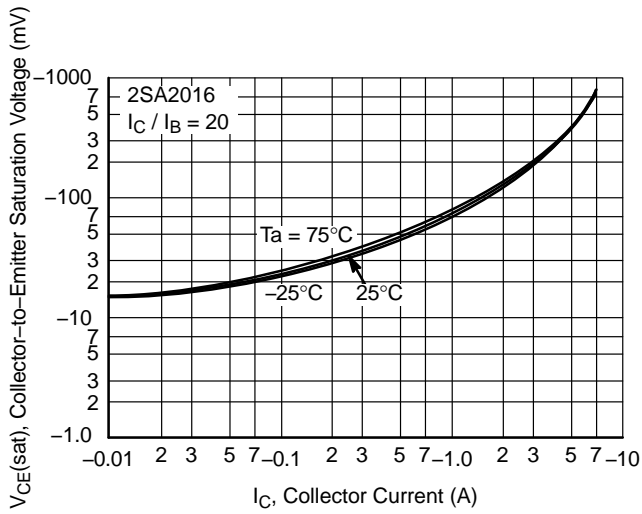

Figure 8. $V_{CE(sat)} - I_C$

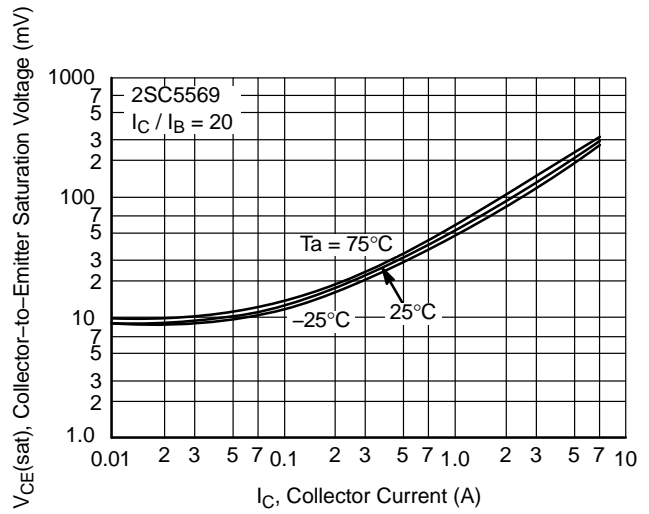

Figure 9. $V_{CE(sat)} - I_C$

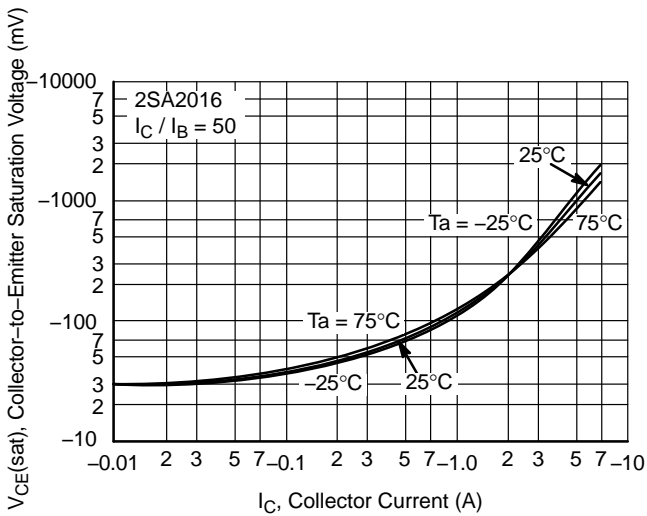

Figure 10. $V_{CE(sat)} - I_C$

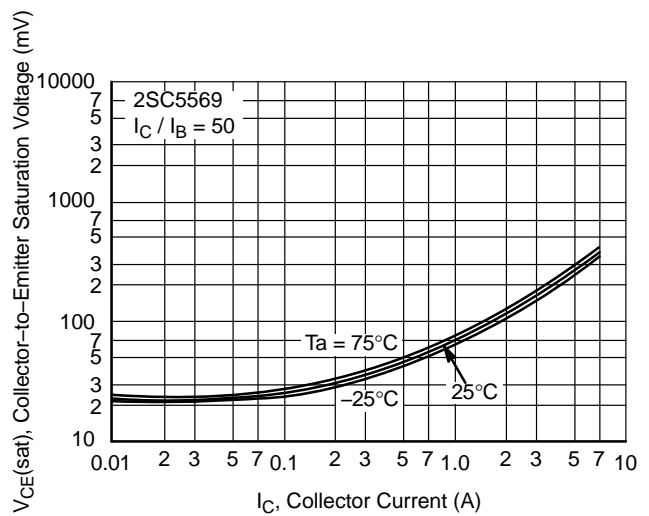

Figure 11. $V_{CE(sat)} - I_C$

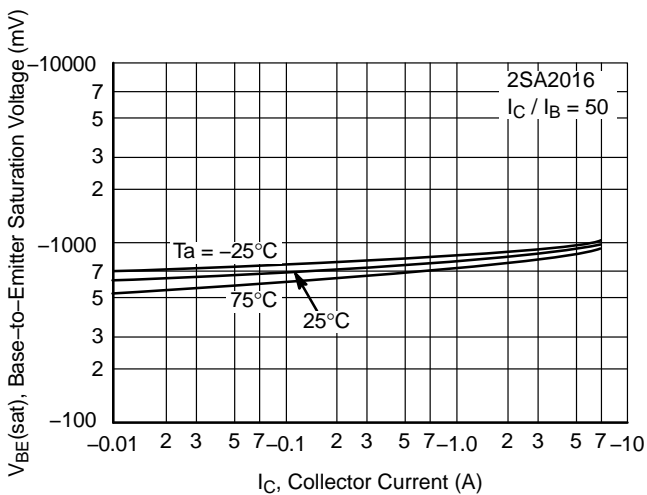

Figure 12. $V_{BE(sat)} - I_C$

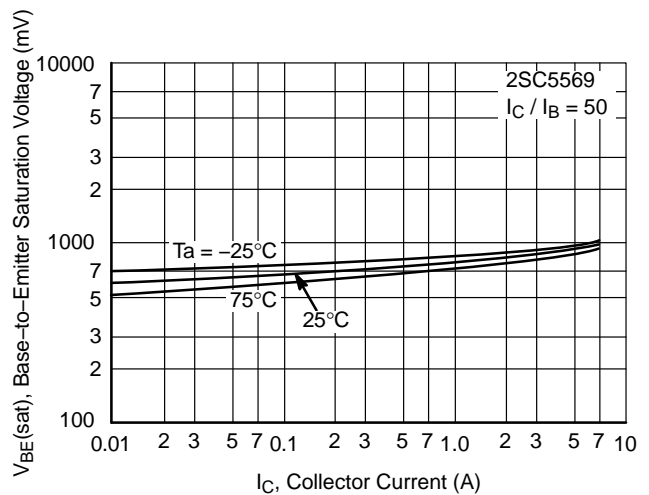

Figure 13. $V_{BE(sat)} - I_C$

2SA2016, 2SC5569

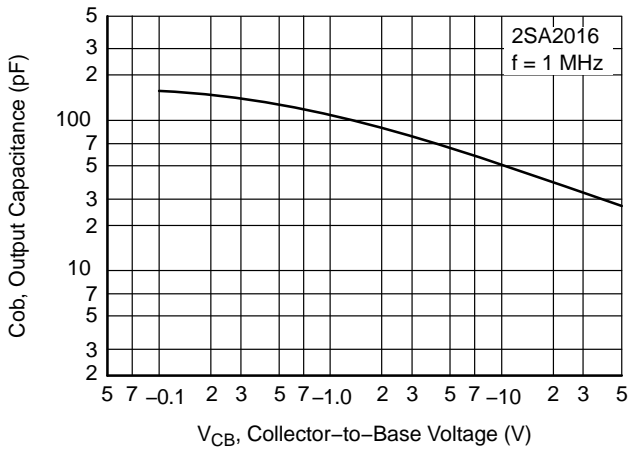

Figure 14. Cob - V_{CB}

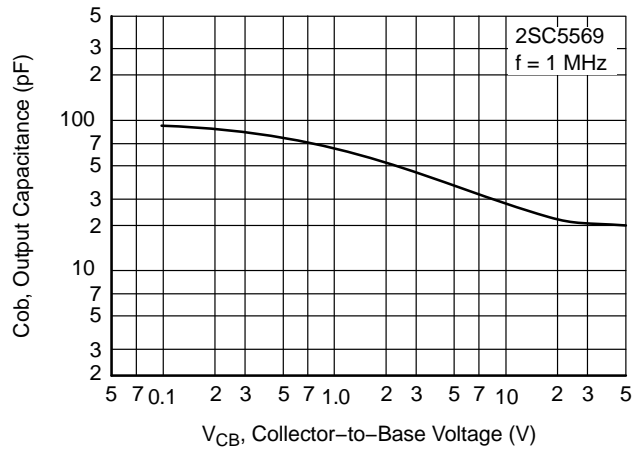

Figure 15. Cob - V_{CB}

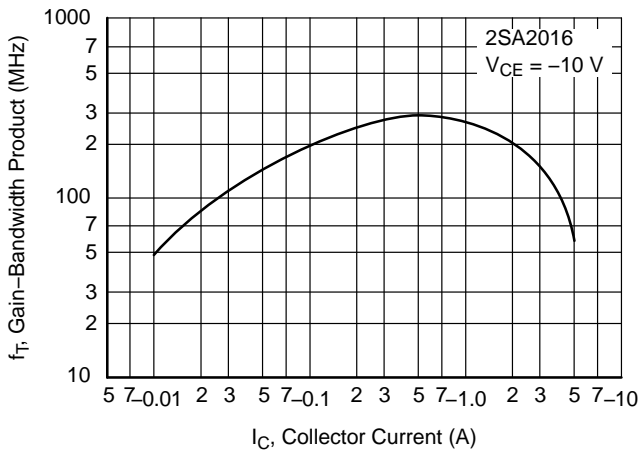

Figure 16. f_T - I_C

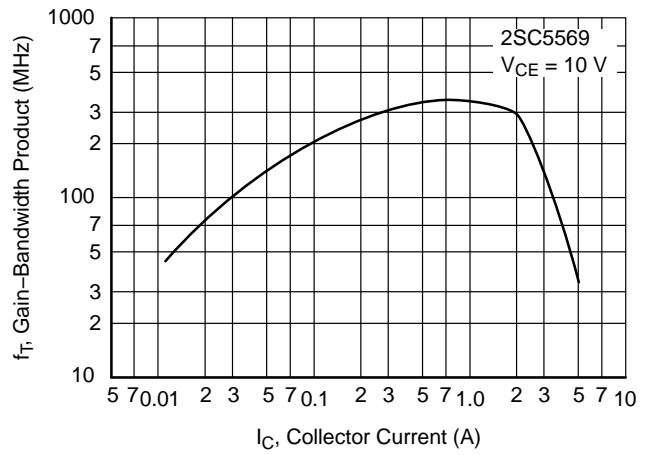

Figure 17. f_T - I_C

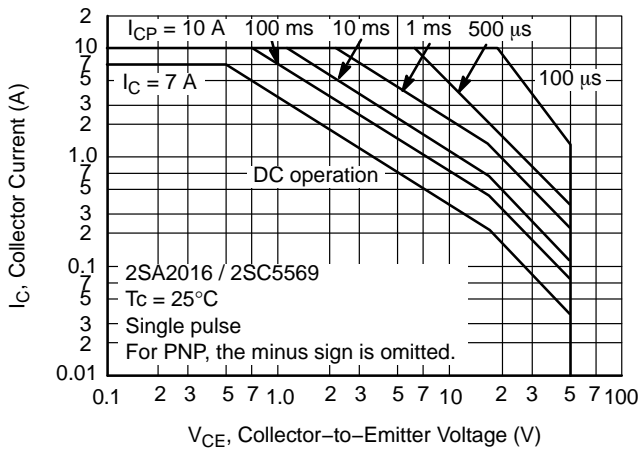

Figure 18. ASO

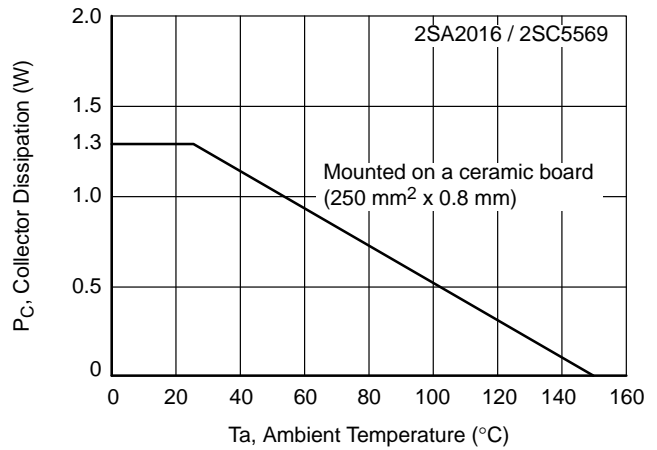

Figure 19. P_C - T_a

2SA2016, 2SC5569

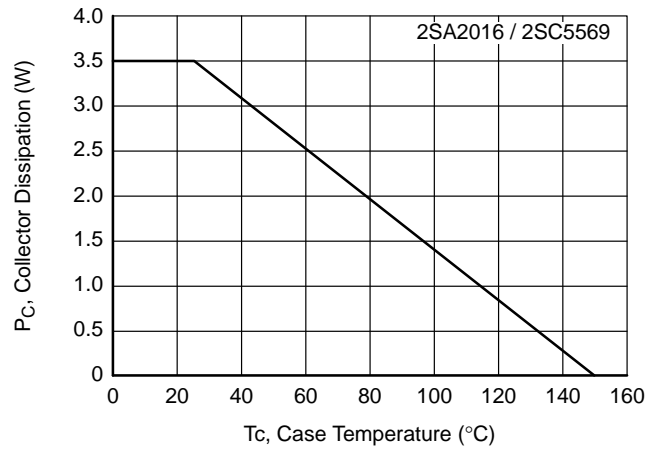
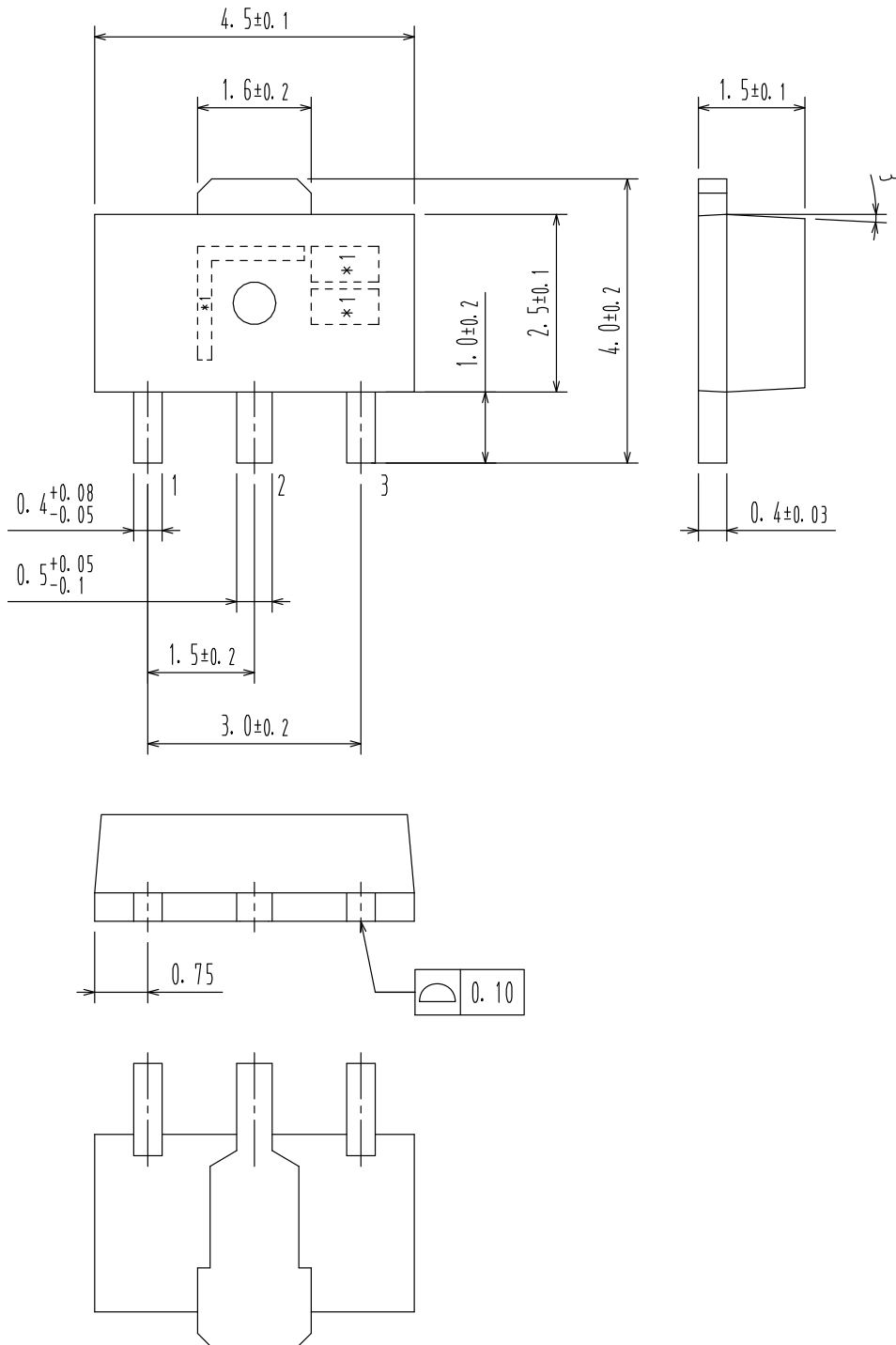

Figure 20. $P_C - T_c$

MECHANICAL CASE OUTLINE
PACKAGE DIMENSIONS

SOT-89 / PCP-1
CASE 419AU
ISSUE 0

DATE 30 APR 2012



DOCUMENT NUMBER:	98AON79746E	Electronic versions are uncontrolled except when accessed directly from the Document Repository. Printed versions are uncontrolled except when stamped "CONTROLLED COPY" in red.
DESCRIPTION:	SOT-89 / PCP-1	PAGE 1 OF 1

ON Semiconductor and  are trademarks of Semiconductor Components Industries, LLC dba ON Semiconductor or its subsidiaries in the United States and/or other countries. ON Semiconductor reserves the right to make changes without further notice to any products herein. ON Semiconductor makes no warranty, representation or guarantee regarding the suitability of its products for any particular purpose, nor does ON Semiconductor assume any liability arising out of the application or use of any product or circuit, and specifically disclaims any and all liability, including without limitation special, consequential or incidental damages. ON Semiconductor does not convey any license under its patent rights nor the rights of others.

onsemi, **Onsemi**, and other names, marks, and brands are registered and/or common law trademarks of Semiconductor Components Industries, LLC dba "**onsemi**" or its affiliates and/or subsidiaries in the United States and/or other countries. **onsemi** owns the rights to a number of patents, trademarks, copyrights, trade secrets, and other intellectual property. A listing of **onsemi**'s product/patent coverage may be accessed at www.onsemi.com/site/pdf/Patent-Marking.pdf. **onsemi** reserves the right to make changes at any time to any products or information herein, without notice. The information herein is provided "as-is" and **onsemi** makes no warranty, representation or guarantee regarding the accuracy of the information, product features, availability, functionality, or suitability of its products for any particular purpose, nor does **onsemi** assume any liability arising out of the application or use of any product or circuit, and specifically disclaims any and all liability, including without limitation special, consequential or incidental damages. Buyer is responsible for its products and applications using **onsemi** products, including compliance with all laws, regulations and safety requirements or standards, regardless of any support or applications information provided by **onsemi**. "Typical" parameters which may be provided in **onsemi** data sheets and/or specifications can and do vary in different applications and actual performance may vary over time. All operating parameters, including "Typicals" must be validated for each customer application by customer's technical experts. **onsemi** does not convey any license under any of its intellectual property rights nor the rights of others. **onsemi** products are not designed, intended, or authorized for use as a critical component in life support systems or any FDA Class 3 medical devices or medical devices with a same or similar classification in a foreign jurisdiction or any devices intended for implantation in the human body. Should Buyer purchase or use **onsemi** products for any such unintended or unauthorized application, Buyer shall indemnify and hold **onsemi** and its officers, employees, subsidiaries, affiliates, and distributors harmless against all claims, costs, damages, and expenses, and reasonable attorney fees arising out of, directly or indirectly, any claim of personal injury or death associated with such unintended or unauthorized use, even if such claim alleges that **onsemi** was negligent regarding the design or manufacture of the part. **onsemi** is an Equal Opportunity/Affirmative Action Employer. This literature is subject to all applicable copyright laws and is not for resale in any manner.

ADDITIONAL INFORMATION

TECHNICAL PUBLICATIONS:

Technical Library: www.onsemi.com/design/resources/technical-documentation
onsemi Website: www.onsemi.com

ONLINE SUPPORT: www.onsemi.com/support

For additional information, please contact your local Sales Representative at www.onsemi.com/support/sales