

## Product Overview

### ADM1026: Thermal System Management Fan Controller

For complete documentation, see the data sheet.

The ADM1026 is a complete system hardware monitor for microprocessor-based systems, providing measurement and limit comparison of various system parameters.

#### Features

- Up to 19 Analog Measurement Channels (Including Internal Measurements)
- Up to 8 Fan Speed Measurement Channels
- Up to 13 General-Purpose Logic I/O Pins
- Remote Temperature Measurement with Remote Diode (Two Channels)
- On-Chip Temperature Sensor
- Analog and PWM Fan Speed Control Outputs
- I2C Compatible System Management (SMBus)
- 8 kbytes on-chip E2PROM
- Chassis Intrusion Detect
- Interrupt Output

For more features, see the data sheet

#### Applications

- Thermal Management

#### End Products

- Notebook and Desktop Computers
- Game Consoles
- RFID Readers
- Multi-Channel Analog Receiver/Amplifier

#### Part Electrical Specifications

Product	Compliance	Status	Data Transmission Standard	I <sub>CC</sub> Max (mA)	V <sub>CC</sub> Min (V)	V <sub>CC</sub> Max (V)	T Min (°C)	T Max (°C)	Package Type
ADM1026JSTZ-REEL	Pb-free Halide free	Active	SMBus	4	3	5.5	0	100	LQFP-48

# Application Diagram

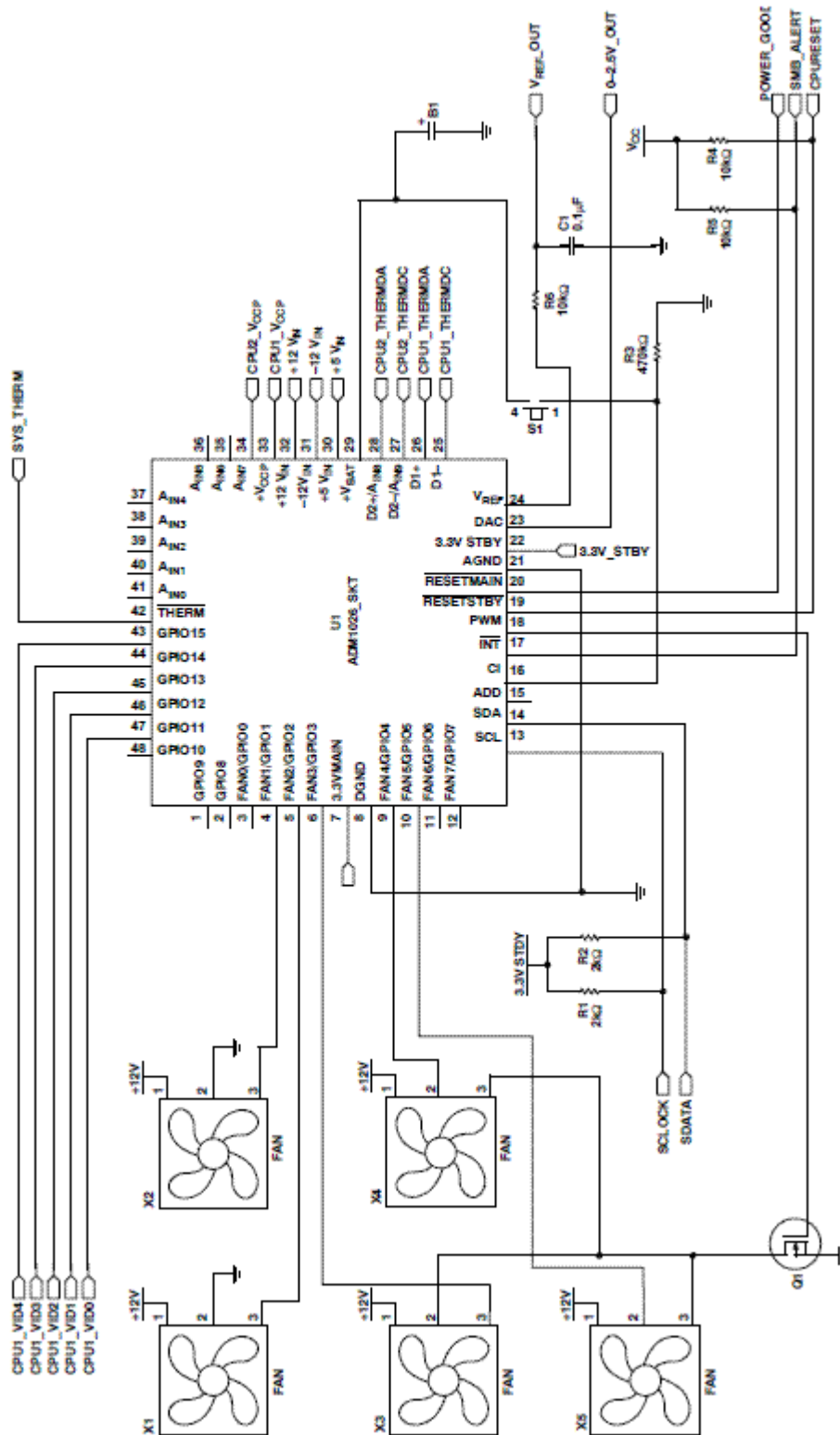

For more information please contact your local sales support at [www.onsemi.com](http://www.onsemi.com).  
 Created on: 1/21/2019