

ON Semiconductor

Is Now

The logo for onsemi, featuring the word "onsemi" in a dark teal, lowercase, sans-serif font. The letter "i" is stylized with a white dot and a teal vertical bar. A small orange triangle is positioned above the top right of the "i". A trademark symbol (TM) is located to the right of the logo.

To learn more about onsemi™, please visit our website at
www.onsemi.com

onsemi and **onsemi** and other names, marks, and brands are registered and/or common law trademarks of Semiconductor Components Industries, LLC dba "**onsemi**" or its affiliates and/or subsidiaries in the United States and/or other countries. **onsemi** owns the rights to a number of patents, trademarks, copyrights, trade secrets, and other intellectual property. A listing of **onsemi** product/patent coverage may be accessed at www.onsemi.com/site/pdf/Patent-Marking.pdf. **onsemi** reserves the right to make changes at any time to any products or information herein, without notice. The information herein is provided "as-is" and **onsemi** makes no warranty, representation or guarantee regarding the accuracy of the information, product features, availability, functionality, or suitability of its products for any particular purpose, nor does **onsemi** assume any liability arising out of the application or use of any product or circuit, and specifically disclaims any and all liability, including without limitation special, consequential or incidental damages. Buyer is responsible for its products and applications using **onsemi** products, including compliance with all laws, regulations and safety requirements or standards, regardless of any support or applications information provided by **onsemi**. "Typical" parameters which may be provided in **onsemi** data sheets and/or specifications can and do vary in different applications and actual performance may vary over time. All operating parameters, including "Typicals" must be validated for each customer application by customer's technical experts. **onsemi** does not convey any license under any of its intellectual property rights nor the rights of others. **onsemi** products are not designed, intended, or authorized for use as a critical component in life support systems or any FDA Class 3 medical devices or medical devices with a same or similar classification in a foreign jurisdiction or any devices intended for implantation in the human body. Should Buyer purchase or use **onsemi** products for any such unintended or unauthorized application, Buyer shall indemnify and hold **onsemi** and its officers, employees, subsidiaries, affiliates, and distributors harmless against all claims, costs, damages, and expenses, and reasonable attorney fees arising out of, directly or indirectly, any claim of personal injury or death associated with such unintended or unauthorized use, even if such claim alleges that **onsemi** was negligent regarding the design or manufacture of the part. **onsemi** is an Equal Opportunity/Affirmative Action Employer. This literature is subject to all applicable copyright laws and is not for resale in any manner. Other names and brands may be claimed as the property of others.

User Guide for
FEBFAN6920MR_T02U120A
Evaluation Board

FAN6920MR BCM PFC with a QR PWM
Combination Controller, FAN7382MX High-
Side Driver, FAN6204MY Secondary-Side
Synchronous Rectifier 19V/120W

Featured Fairchild Product:
FAN6920MR

***Direct questions or comments
about this evaluation board to:
“Worldwide Direct Support”***

Fairchild Semiconductor.com

Table of Contents

1. Introduction.....	4
1.1. General Specifications.....	4
2. Input Current.....	5
2.1. Test Condition	5
2.2. Test Result	5
3. Input Wattage at No-Load Condition	5
3.1. Test Condition	5
3.2. Test Result	5
3.3. Measured Waveform	6
4. Turn-On Time	7
4.1. Test Condition	7
4.2. Test Result	7
4.3. Measured Waveform	7
5. DC Output Rising Time	8
5.1. Test Condition	8
5.2. Test Result	8
5.3. Measured Waveform	8
6. Line & Load Regulation	10
6.1. Test Condition	10
6.2. Test Result	10
7. Efficiency.....	10
7.1. Test Condition	10
7.2. Test Result	10
8. Light-Load Specification	11
8.1. Test Condition	11
8.2. Test Result	11
9. Light-Load Efficiency.....	11
9.1. Test Condition	11
9.2. Test Result	11
10. Output Ripple & Noise	12
10.1. Test Condition	12
10.2. Test Result	12
10.3. Measured Waveforms.....	12
11. Step Response	13
11.1. Test Condition	13
11.2. Test Result	13
11.3. Measured Waveform	13
12. Over-Voltage Protection	14
12.1. Test Condition	14
12.2. Test Result	14
12.3. Measured Waveform	14
13. Over-Power Protection.....	15
13.1. Test Condition	15
13.2. Test Result	15

14. Hold-Up Time	15
14.1. Test Condition	15
14.2. Test Result	15
14.3. Measured Waveform	16
15. Short-Circuit Protection	17
15.1. Test Condition	17
15.2. Test Result	17
15.3. Measured Waveforms	17
16. Brownout Test	18
16.1. Test Condition	18
16.2. Test Result	18
17. V _{DD} Voltage Level	18
17.1. Test Result	18
17.2. Measured Waveform	19
18. Voltage Stress on MOSFET & Rectifiers	21
18.1. Test Condition	21
18.2. Test Result	21
18.3. Measured Waveforms	21
19. Current Harmonic Test	23
19.1. Test Condition	23
19.2. Test Result	23
20. EMI Test	24
21. Surge Test	27
22. ESD Test	27
23. System Reliability Test	28
24. Photographs	29
25. Schematic	30
26. Board Layout	31
27. Bill of Materials, Main Board	33
27.1. Bill of Materials, FAN7382 Card	35
28. Specification Approval	36
29. Revision History	50

The following user guide supports the demonstration kit for the FAN6920MR. It should be used in conjunction with the FAN6920MR, FAN7382MX, and FAN6204MY datasheets as well as Fairchild's application notes and technical support team. Please visit Fairchild's website at www.fairchildsemi.com.

1. Introduction

This document describes the FAN6920MR BCM PFC with a QR PWM combination controller, as well as FAN7382MX high-side driver, and the FAN6204MY secondary-side synchronous rectifier 19V/120W evaluation board.

1.1. General Specifications

Specification	Min.	Max.	Units
Input			
Voltage	90	264	V _{AC}
Frequency	60	50	Hz
Output			
Output Voltage 1	19	19	V
Output Current 1	0	6.3	A
Total Output Power			
Full-load Output Power		120	W

Table 1. Test Details

Test Model	FEBFAN6920MR_T02U120A
Test Date	2011-08-12
Test Temperature	Ambient
Test Equipment	AC Source: 6220 AC POWER SOURCE Electronic Load: Chroma 63030 Power Meter: WT210 Oscilloscope: LeCroy 24Xs
Test Items	Input current Input wattage at no-load condition Turn-on time DC output rising time Line & load regulation Efficiency Light-load specification Light-load efficiency Output ripple & noise Step response Over-voltage protection Over-power protection Hold up time Short-circuit protection Brownout test

	<p>V_{DD} voltage level Voltage stress on MOSFET & rectifiers Current harmonic test EMI test Surge test ESD test System reliability test</p>
--	--

2. Input Current

2.1. Test Condition

Measure the AC input current at maximum loading.

2.2. Test Result

Input Voltage	Input Current
90V / 60Hz	1.485A
264V / 50Hz	0.505A

3. Input Wattage at No-Load Condition

3.1. Test Condition

Measure the input wattage and output voltage at no load.

3.2. Test Result

Input Voltage	Input Wattage(W)	Output Voltage(V)	Specification
90V / 60Hz	0.161	19.154	240V _{AC} < 0.3W
115V / 60Hz	0.166	19.154	
230V / 50Hz	0.184	19.154	
240V / 50Hz	0.188	19.154	
264V / 50Hz	0.196	19.154	

3.3. Measured Waveform

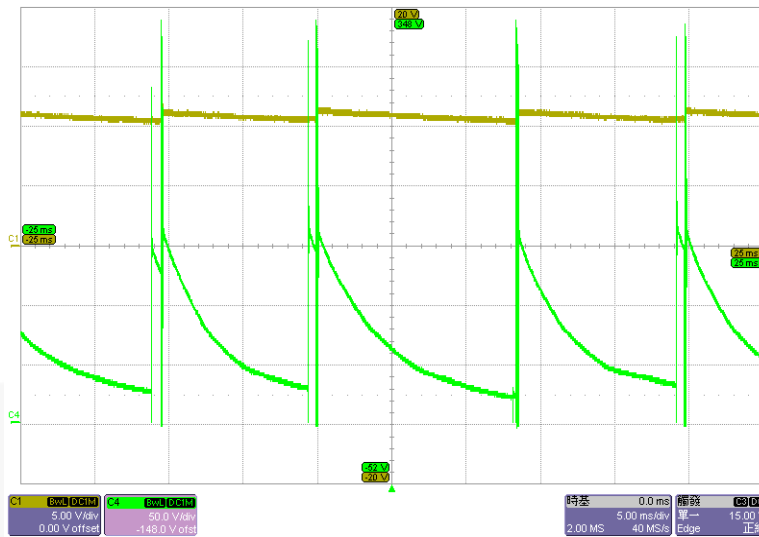

Figure 1. 90V / 60Hz at No Load, Ch1: V_{DD}, Ch4: V_{DS}

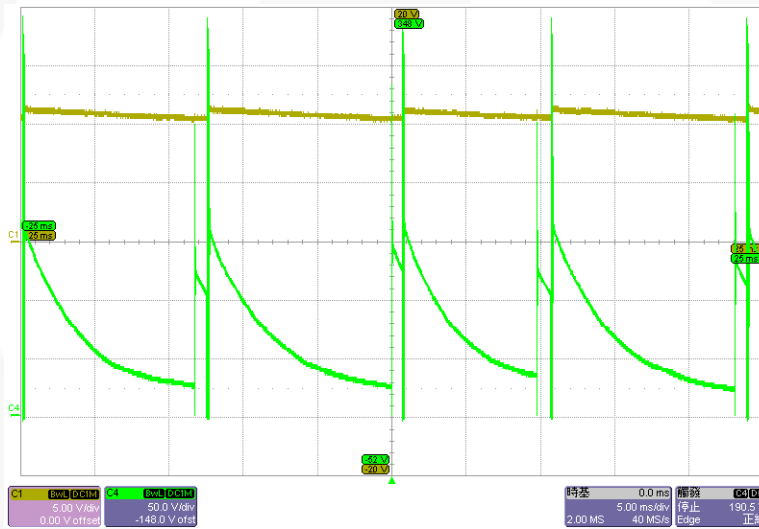

Figure 2. 264V / 50Hz at No Load, Ch1: V_{DD}, Ch4: V_{DS}

4. Turn-On Time

4.1. Test Condition

Set output at maximum loading. Measure the interval between AC plug-in and stable output.

4.2. Test Result

Input Voltage	Turn-On Time (s)
90V / 60Hz	1.563
264V / 50Hz	0.914

4.3. Measured Waveform

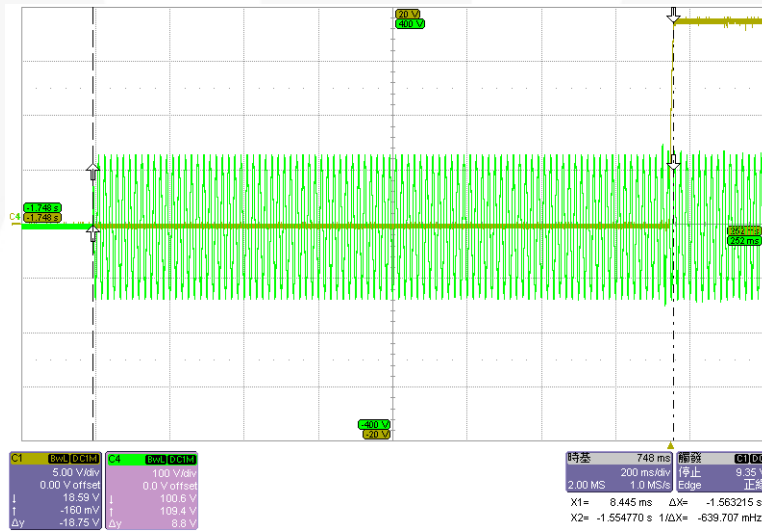

Figure 3. 90V / 60Hz at Maximum Load, Ch1:V_O, Ch4:V_{AC}

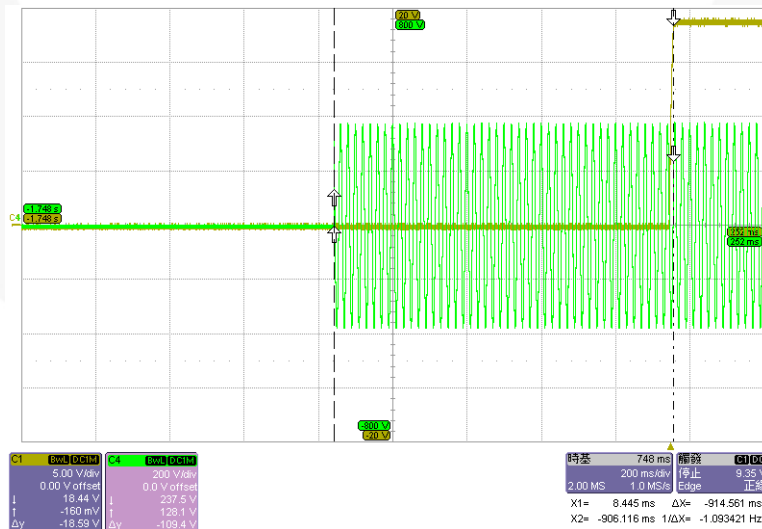

Figure 4. 264V / 50Hz at Maximum Load, Ch1:V_O, Ch4:V_{AC}

5. DC Output Rising Time

5.1. Test Condition

Set output at maximum loading. Measure the time interval between 10% and 90% output during startup.

5.2. Test Result

Input Voltage	Maximum Load (ms)	No Load (ms)	Specification
90V / 60Hz	10.039	4.976	<30ms
264V / 50Hz	9.070	4.583	

5.3. Measured Waveform

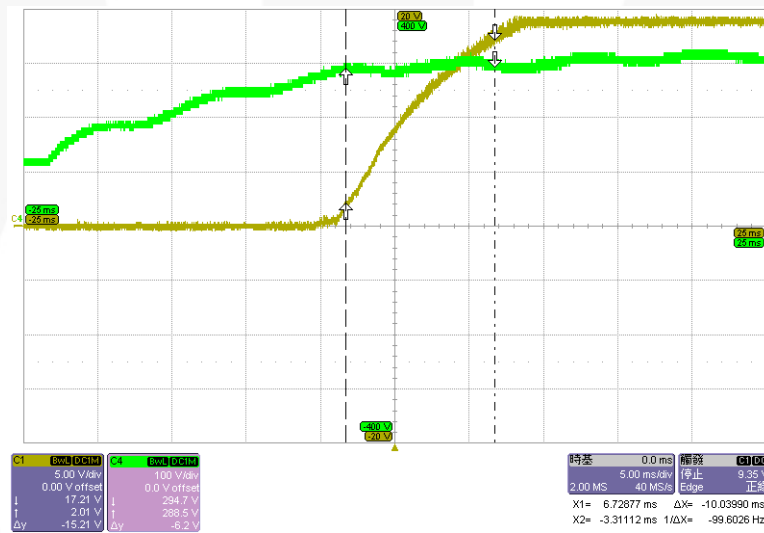

Figure 5. 90V / 60Hz at Maximum Load, Ch1: V_O, Ch4: V_{DC}

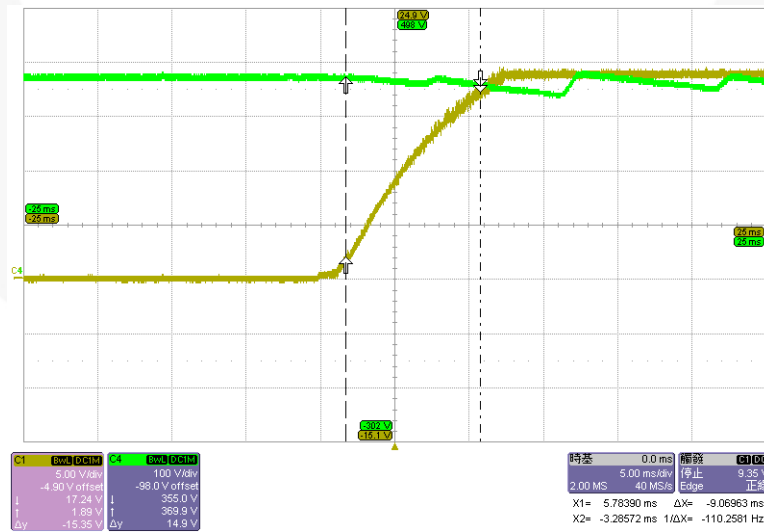

Figure 6. 264V / 50Hz at Maximum Load, Ch1: V_O, Ch4: V_{DC}

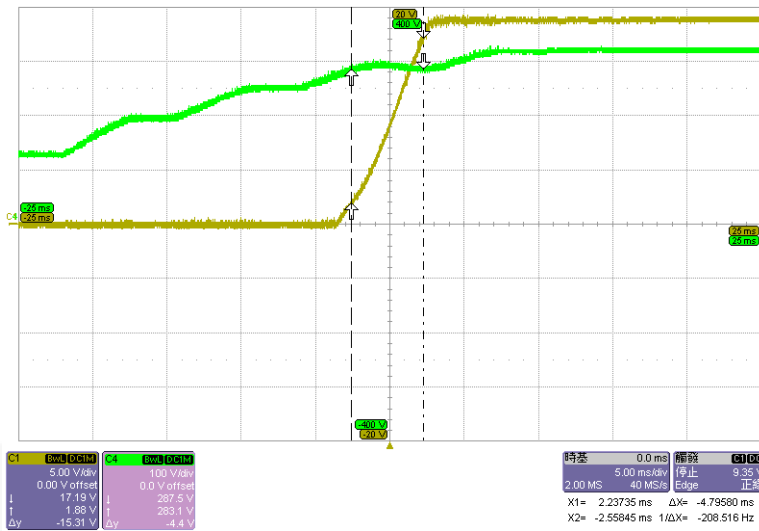

Figure 7. 90V / 60Hz at No Load, Ch1 V_O, Ch4: V_{DC}

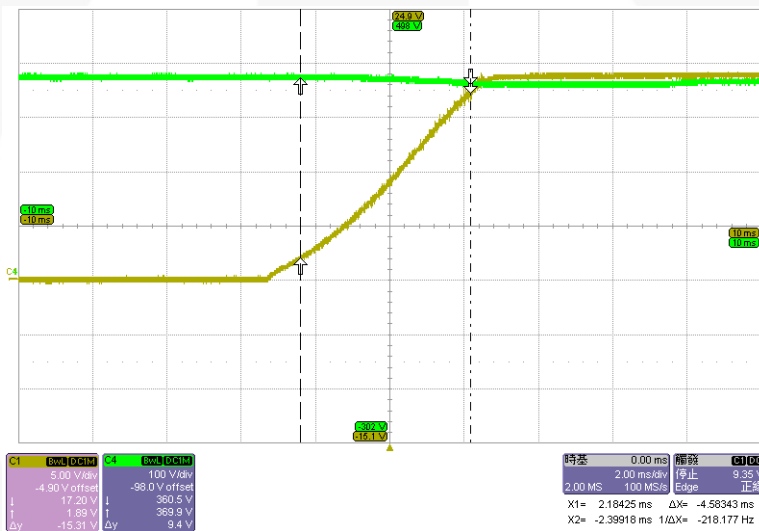

Figure 8. 264V / 50Hz at No Load, Ch1: V_O, Ch4: V_{DC}

6. Line & Load Regulation

6.1. Test Condition

Measure line & load regulation according to the table below.

6.2. Test Result

Input Voltage	Output Voltage at Maximum Load (V)	Output Voltage at Minimum Load (V)	Load Regulation (%)
90V / 60Hz	19.091	19.101	0.052
115V / 60Hz	19.090	19.100	0.052
132V / 60Hz	19.089	19.099	0.052
180V / 50Hz	19.084	19.098	0.073
230V / 50Hz	19.083	19.097	0.073
264V / 50Hz	19.083	19.097	0.073
Line Regulation (%)	0.042	0.021	

7. Efficiency

7.1. Test Condition

Output at 25%, 50%, 75%, and 100% load.

7.2. Test Result

Output Watt	30W	60W	90W	120W	Avg.	Specification
90V / 60Hz	87.61	90.84	90.78	90.02	89.81	>87%
115V / 60Hz	88.39	91.72	91.95	91.65	90.93	
230V / 50Hz	91.92	91.54	92.64	93.15	92.31	
264V / 50Hz	91.50	91.45	92.78	93.33	92.27	

8. Light-Load Specification

8.1. Test Condition

Output wattage at light load.

8.2. Test Result

Output Wattage		Actual Output Wattage	Input Wattage	Specification
0W	115V _{AC}	0	0.166	Input Watt <0.3W
	230V _{AC}	0	0.184	
0.5W	115V _{AC}	0.484	0.737	Input Watt <1W
	230V _{AC}	0.484	0.747	
1W	115V _{AC}	0.998	1.348	Input Watt <1.7W
	230V _{AC}	0.994	1.303	
1.15W	115V _{AC}	1.142	1.504	Input Watt <2.16W
	230V _{AC}	1.142	1.528	
1.5W	115V _{AC}	1.486	1.902	Input Watt <2.4W
	230V _{AC}	1.486	1.934	
1.7W	115V _{AC}	1.687	2.174	Input Watt <2.4W
	230V _{AC}	1.683	2.149	

9. Light-Load Efficiency

9.1. Test Condition

Output efficiency at light load.

9.2. Test Result

Output Wattage		Output Wattage	Input Wattage	Efficiency	Specification
≤1W	115V _{AC}	0.998	1.348	74.03	≥ 58%
	230V _{AC}	0.994	1.303	76.29	
≤1.7W	115V _{AC}	1.687	2.174	77.60	≥ 68%
	230V _{AC}	1.683	2.149	78.32	
≤2.4W	115V _{AC}	2.377	2.984	79.66	≥ 73%
	230V _{AC}	2.398	2.985	80.34	
≤14W	115V _{AC}	13.990	16.290	85.88	≥ 83%
	230V _{AC}	14.000	15.900	88.05	
≤22W	115V _{AC}	21.970	25.150	87.36	≥ 85%
	230V _{AC}	21.990	24.570	89.50	

10. Output Ripple & Noise

10.1. Test Condition

Ripple and noise are measured by using a 20MHz bandwidth-limited oscilloscope with a 10 μ F capacitor paralleled with a high-frequency 0.1 μ F capacitor across each output.

10.2. Test Result

Input Voltage	Maximum Load (mV)	Minimum Load (mV)
90V / 60Hz	91.6	27.4
115V / 60Hz	89.6	31.6
230V / 50Hz	78.6	31.6
264V / 50Hz	75.8	36.6

10.3. Measured Waveforms

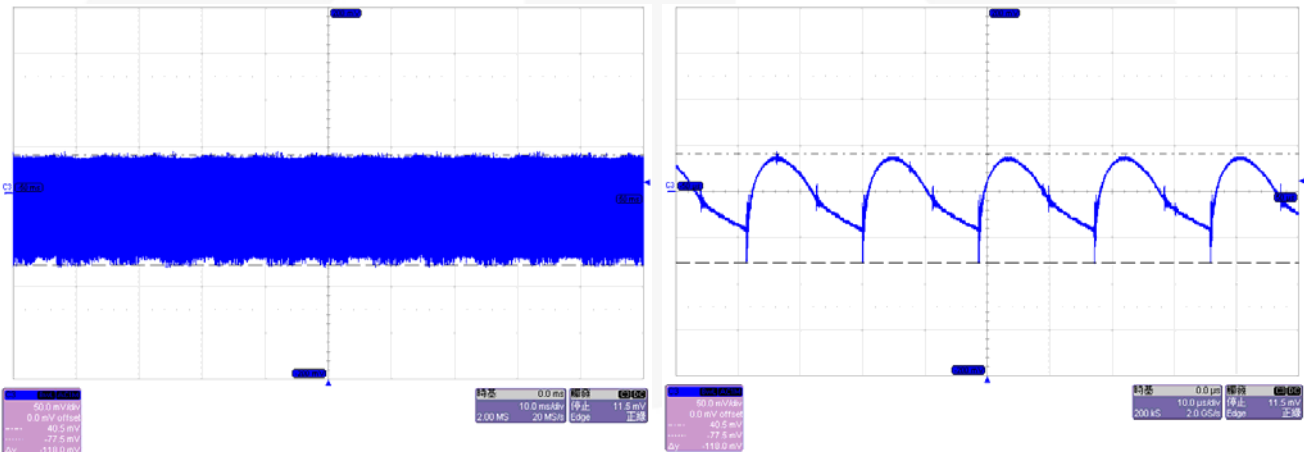

Figure 9. 90V / 60Hz at Maximum Load, Ch3: V_O

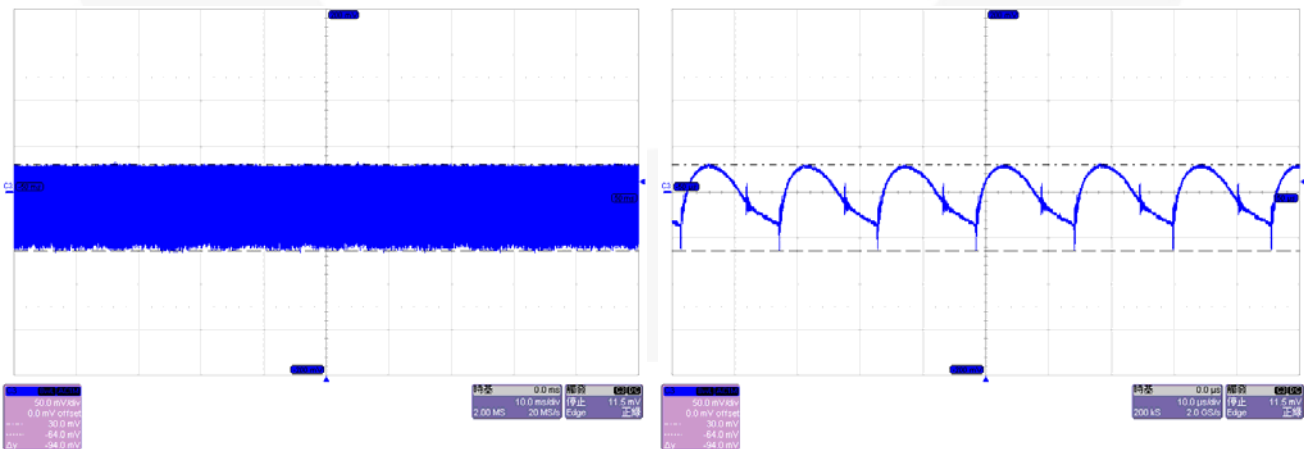

Figure 10. 264V / 50Hz at Maximum Load, Ch3: V_O

11. Step Response

11.1. Test Condition

Dynamic loading (20%~80% of the full load, 5ms duty cycle, and 2.5A/ μ s rise / fall time).

11.2. Test Result

Input Voltage	Overshoot (mV)	Undershoot (mV)
115V / 60Hz	187.5	167.5
230V / 50Hz	181.5	171.5

11.3. Measured Waveform

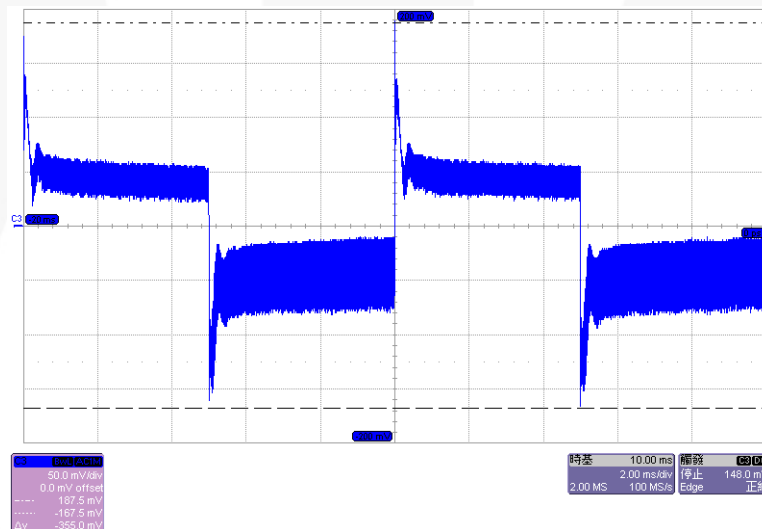

Figure 11. 115V / 60Hz at Maximum Load, Ch3: V_O

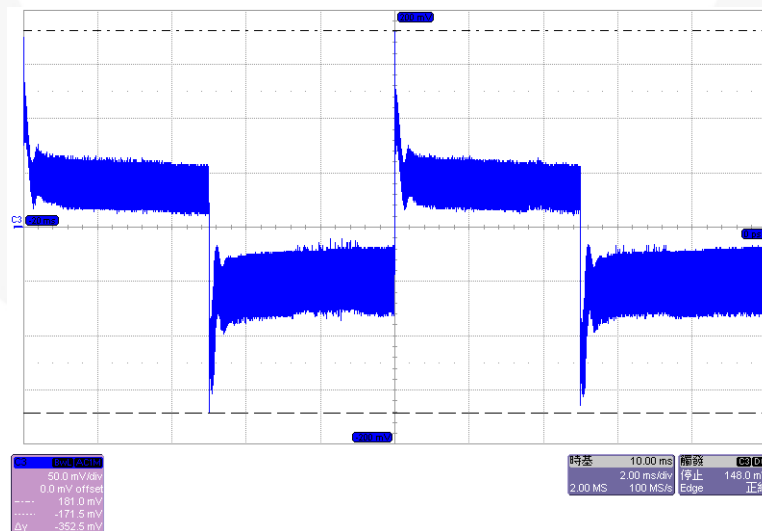

Figure 12. 230V/50Hz at Maximum Load, Ch3: V_O

12. Over-Voltage Protection

12.1. Test Condition

Short the secondary side of opto-coupler at maximum load.

12.2. Test Result

Input Voltage	Output Voltage (Maximum Value) (V)
115V/60Hz	23.4
230V/50Hz	23.4

12.3. Measured Waveform

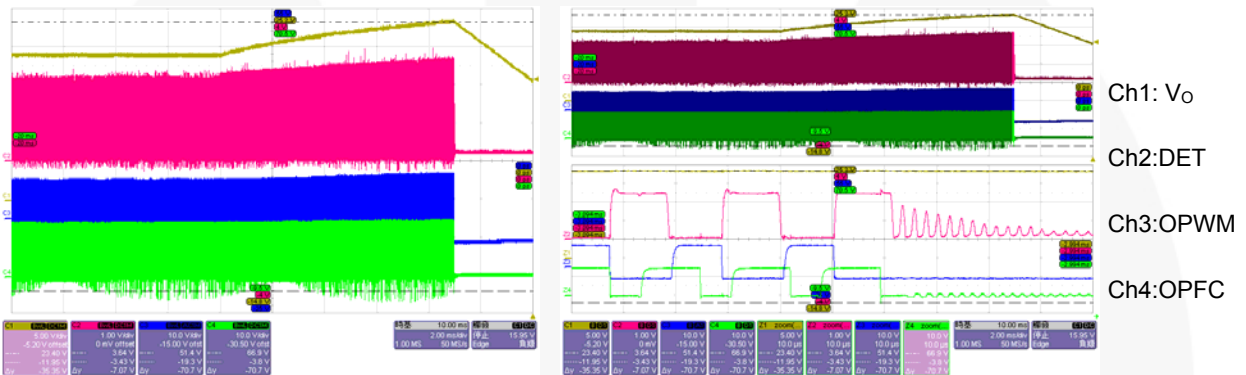

Figure 13. 115V / 60Hz at Maximum Load

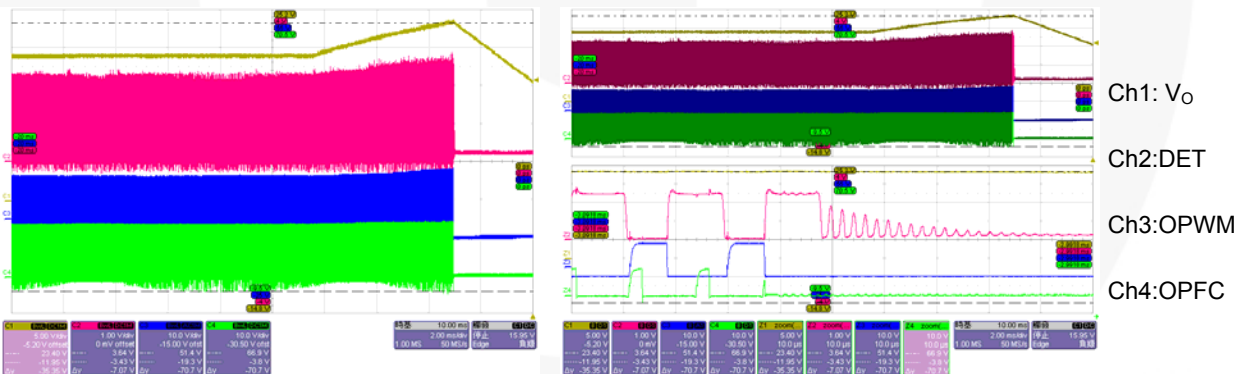

Figure 14. 230V / 50Hz at Maximum Load

13. Over-Power Protection

13.1. Test Condition

Increase output loading gradually.

13.2. Test Result

Input Voltage	Output Power (W)	Output Current (A)	Specification
90V/60Hz	156.01	8.236	>120% <150% Full Load
115V/60Hz	155.78	8.221	
230V/50Hz	168.24	8.880	
264V/50Hz	168.45	8.865	

14. Hold-Up Time

14.1. Test Condition

Set output at maximum load. Measure the time interval between AC off and output voltage falling to the lower limit of the rated value. The AC waveform should be off at zero degree.

14.2. Test Result

Input Voltage	Hold-Up Time (ms)
90V / 60Hz	21.31
115V / 60Hz	20.80
230V / 50Hz	51.95
264V / 50Hz	51.95

14.3. Measured Waveform

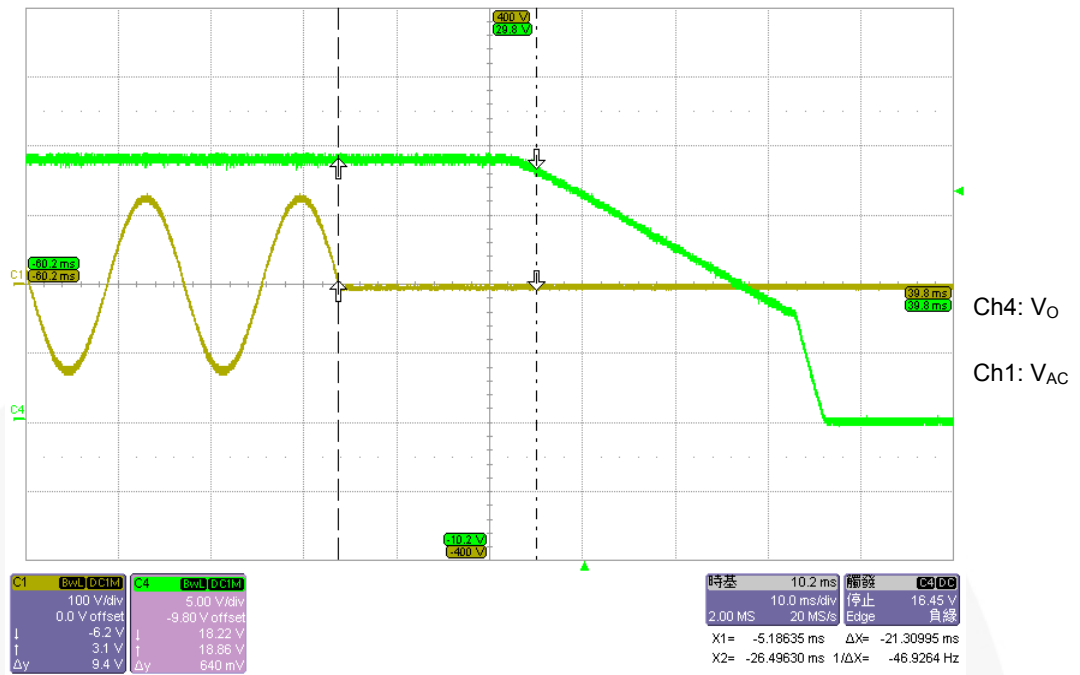

Figure 15. 90V / 60Hz at Maximum Load

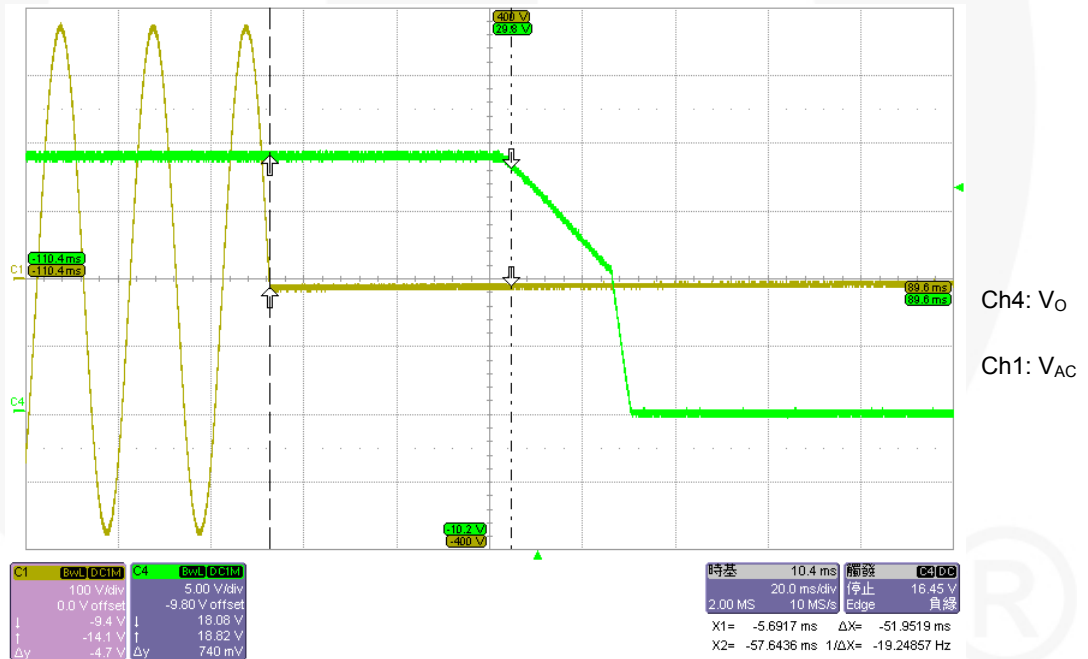

Figure 16. 264V / 50Hz at Maximum Load

15. Short-Circuit Protection

15.1. Test Condition

Short the output of the power supply. The power supply should enter “Hiccup” Mode protection with less than 2W input voltage.

15.2. Test Result

Input Voltage	Input Wattage at Maximum Loading (W)	Input Wattage at Minimum Loading (W)	Specification
90V/60Hz	1.231	1.25	<2W
264V/50Hz	1.344	1.45	

15.3. Measured Waveforms

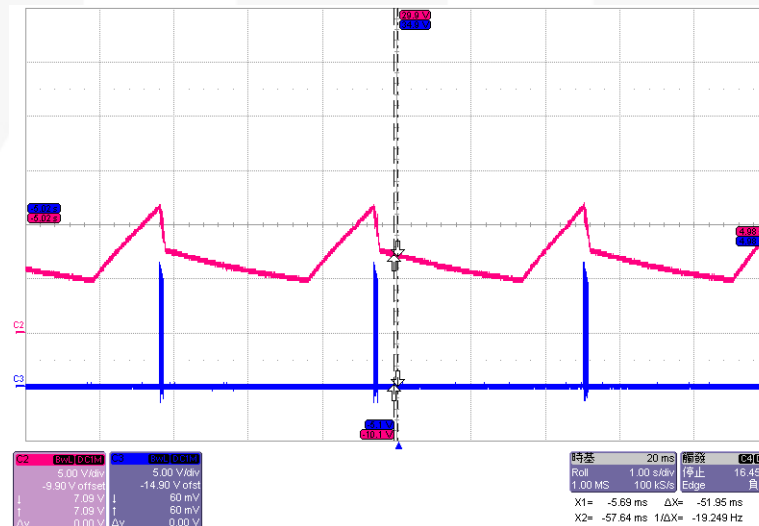

Figure 17. 90V / 60Hz at Maximum Load

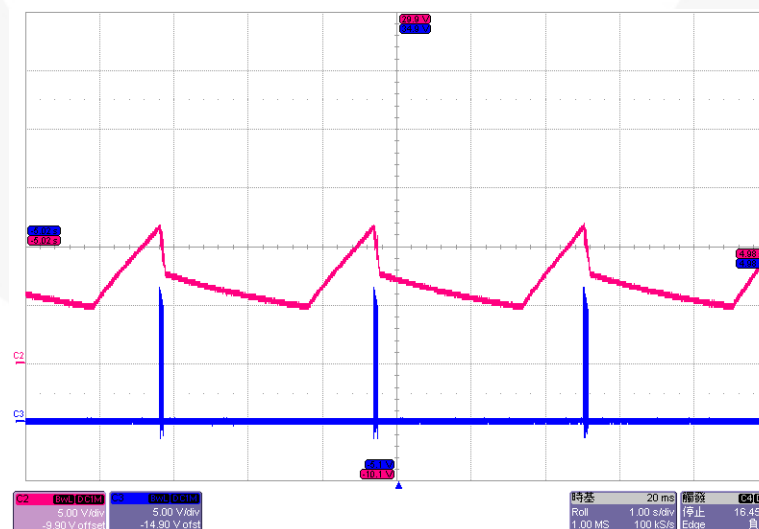

Figure 18. 264V / 50Hz at Maximum Load

16. Brownout Test

16.1. Test Condition

Set output at maximum loading. Decrease input voltage with 5VAC step. Record input wattage and output voltage. After the output is off, increase the AC voltage gradually and record the recovery voltage.

16.2. Test Result

Input Voltage	Input Wattage	Output Voltage
90V / 60Hz	132.9	19.088
85V / 60Hz	133.5	19.088
80V / 60Hz	134.4	19.086
75V / 60Hz	135.4	19.084
70V / 60Hz	136.9	19.084
67V / 60Hz	0	0

Recovery voltage: 77 V_{AC}

17. V_{DD} Voltage Level

17.1. Test Result

Input Voltage	Min. Load (V)	Max. Load (V)	Near OPP(V)	Output S.C. (Max. Value) (V)
90V / 60Hz	10.35~11.65	16.40	17.35	11.65
264V / 50Hz	10.25~11.95	16.00	17.65	11.65

17.2. Measured Waveform

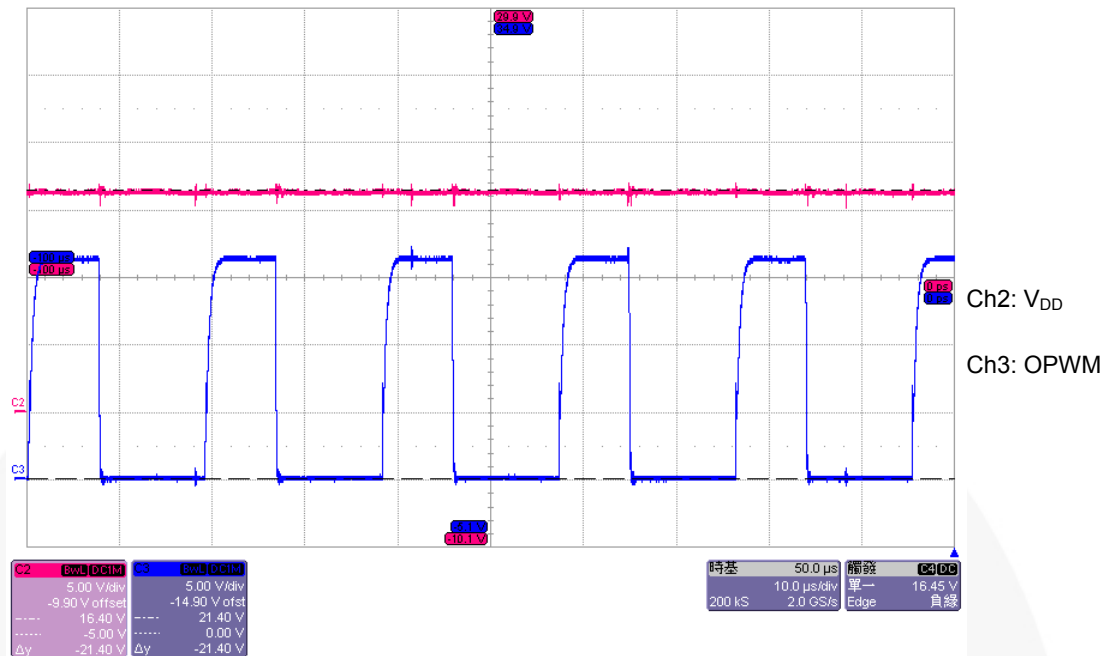

Figure 19. 90V / 60Hz at Maximum Load

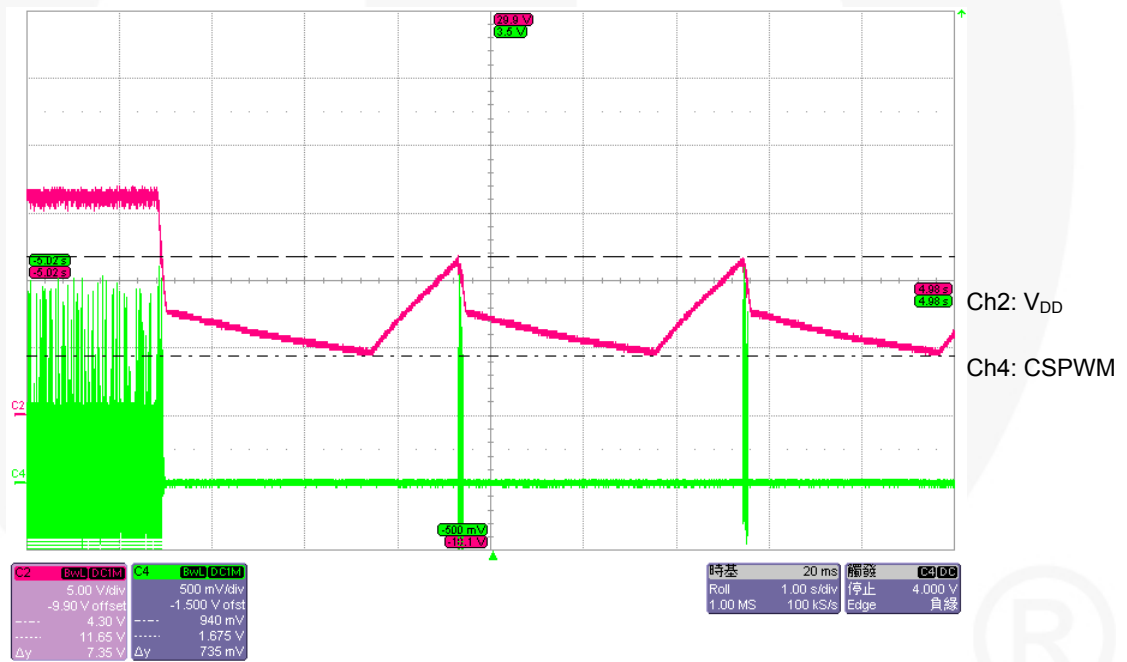

Figure 20. 90V / 60Hz at Output Short Circuited

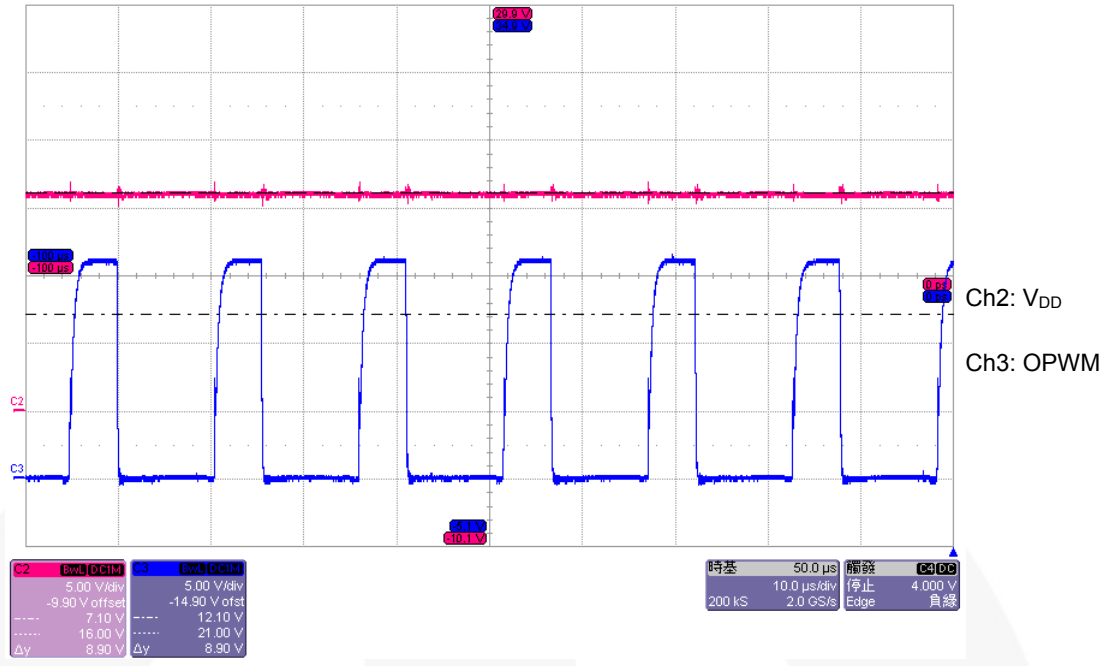

Figure 21. 264V / 50Hz at Maximum Load

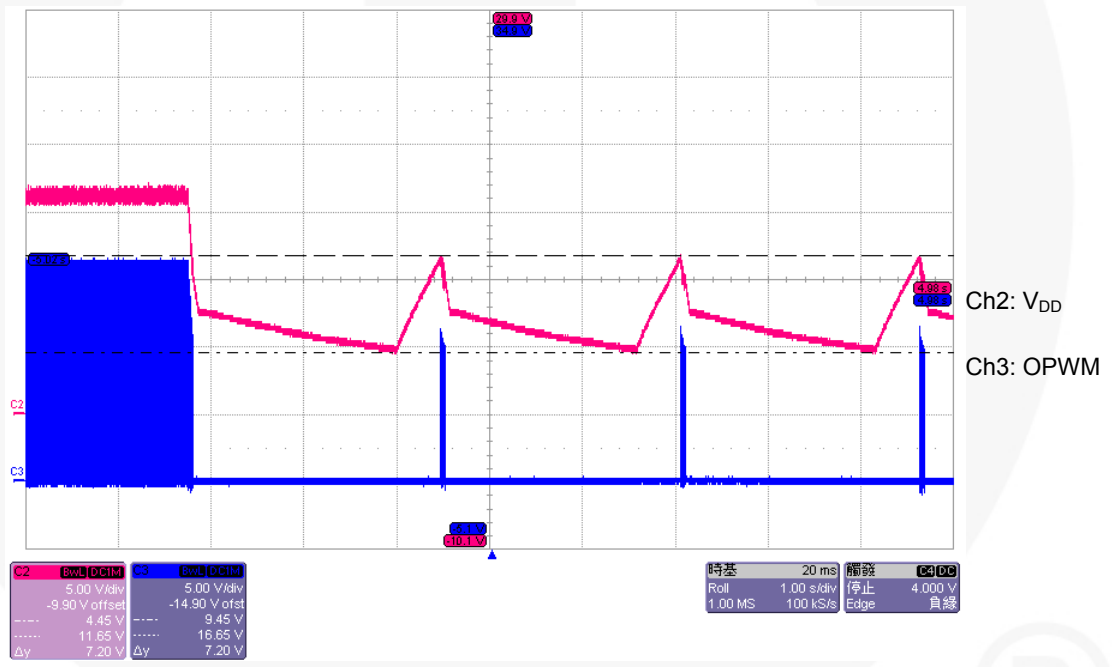

Figure 22. 264V / 50Hz at Output Short Circuited

18. Voltage Stress on MOSFET & Rectifiers

18.1. Test Condition

Measure the voltage stress on MOSFET and secondary rectifiers under below specified conditions.

18.2. Test Result

Input Voltage	Stress on MOSFET (V)	Rating	Stress on Output Rectifier (V)	Rating
90V / 60Hz, Max. Load	338	600V	45.8	75V
90V / 60Hz, Max. Load, Startup	365		57.4	
90V / 60Hz, Max. Load, Output Short	379		62.0	
264V / 50Hz, Max. Load	437		55.2	
264V / 50Hz, Max. Load, Startup	442		66.2	
264V / 50Hz, Max. Load, Output Short	456		70.2	
264V / 50Hz, Max. Load, Turn Off	437		55.6	

18.3. Measured Waveforms

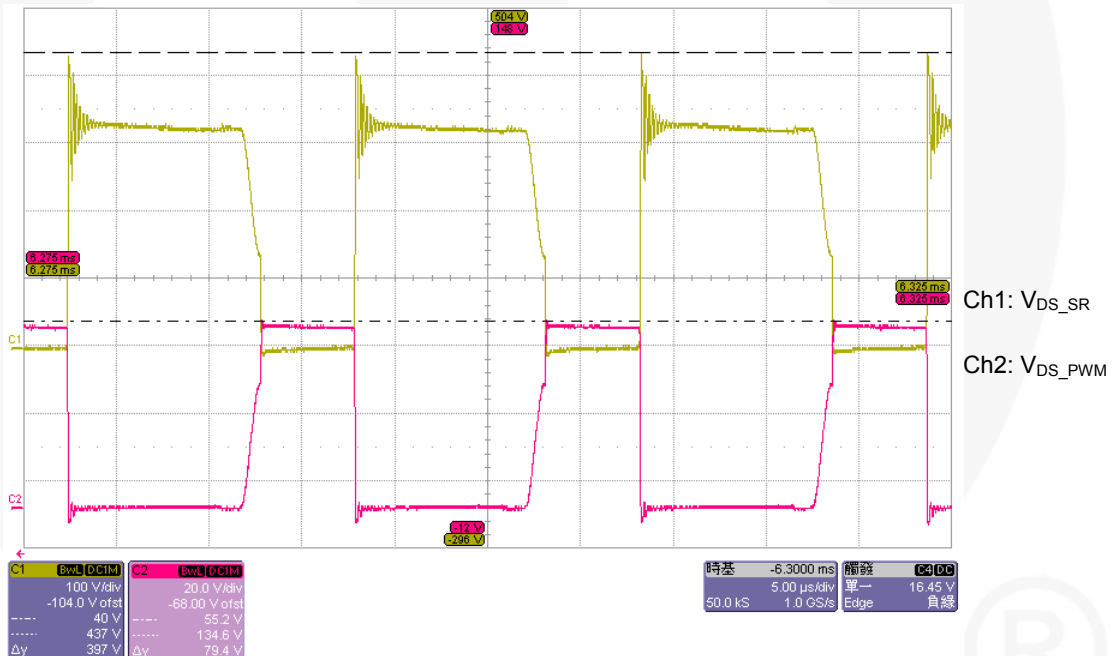

Figure 23. 264V/50Hz max load

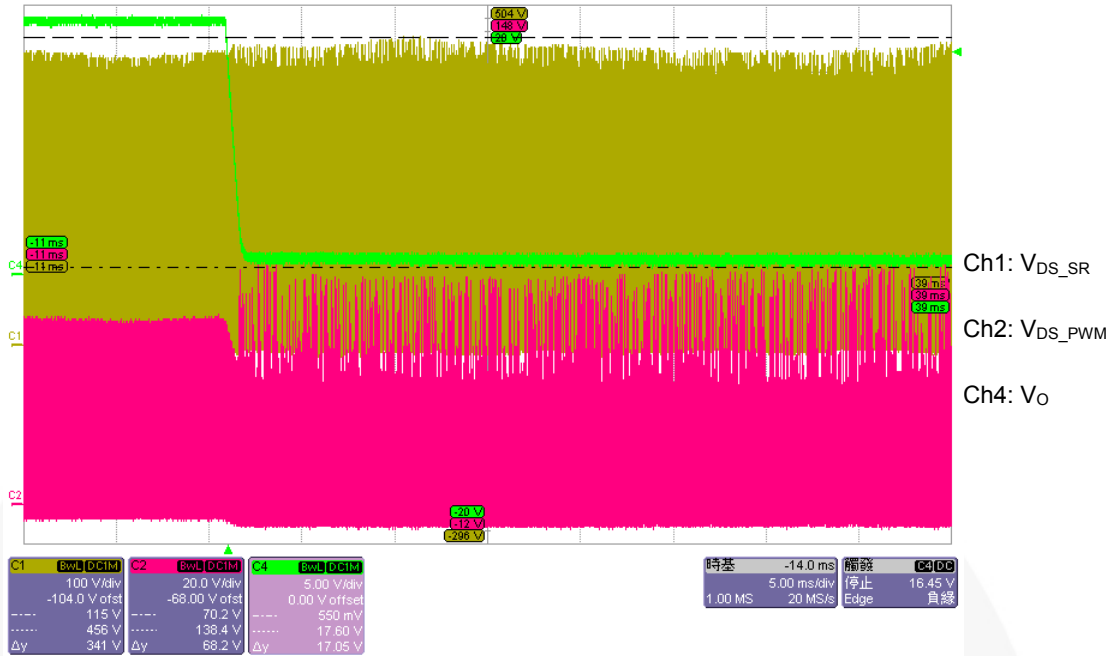

Figure 24. 264V/50Hz Short circuit

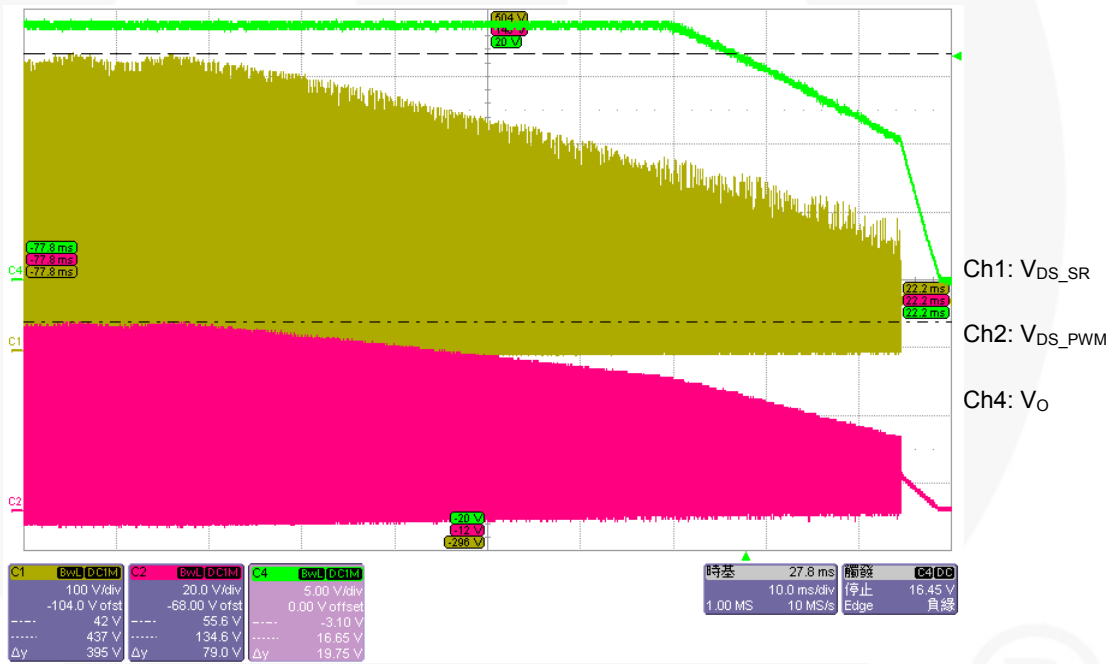

Figure 25. 264V/50Hz max load turn off

19. Current Harmonic Test

19.1. Test Condition

Load: Pi=75W & maximum load.

19.2. Test Result

Input Voltage		Full Load		Specification
		PF	THD (%)	
90V / 60Hz	Pi=75W	0.997	4.84	IEC1000-3-2 Class D
	Max. Load	0.999	2.97	
115V / 60Hz	Pi=75W	0.994	5.59	
	Max. Load	0.998	3.49	
240V / 50Hz	Pi=75W	0.947	13.69	
	Max. Load	0.979	7.54	
264V / 50Hz	Pi=75W	0.928	16.87	
	Max. Load	0.970	9.18	

20. EMI Test

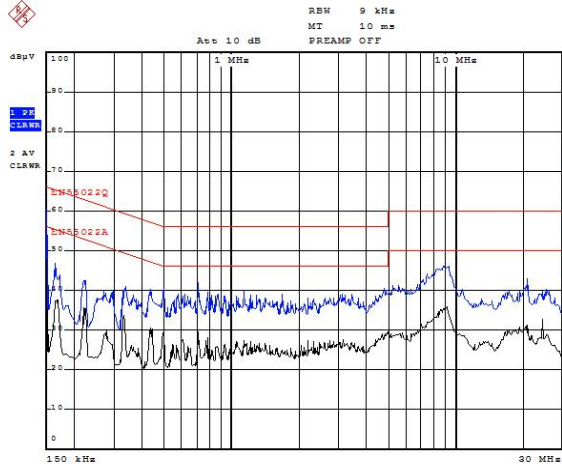

Figure 26. Conduction Line at 115V_{AC} Full Load

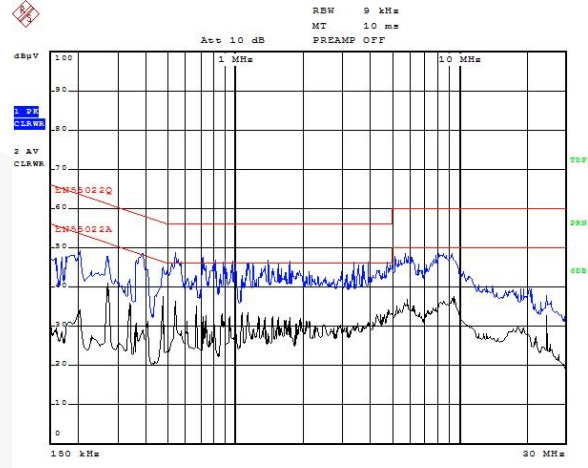

Figure 27. Conduction Line at 230V_{AC} Full Load

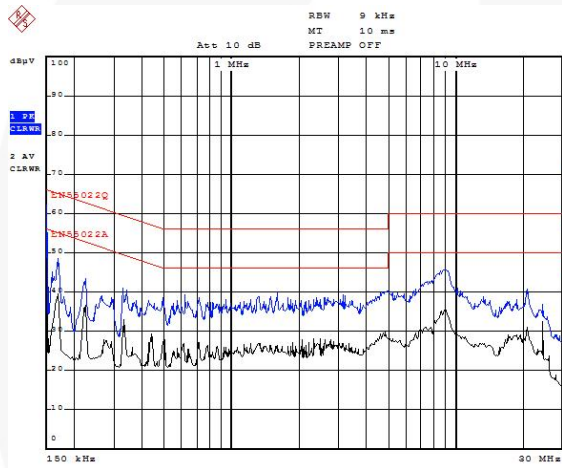

Figure 28. Conduction Neutral at 115V_{AC} Full Load

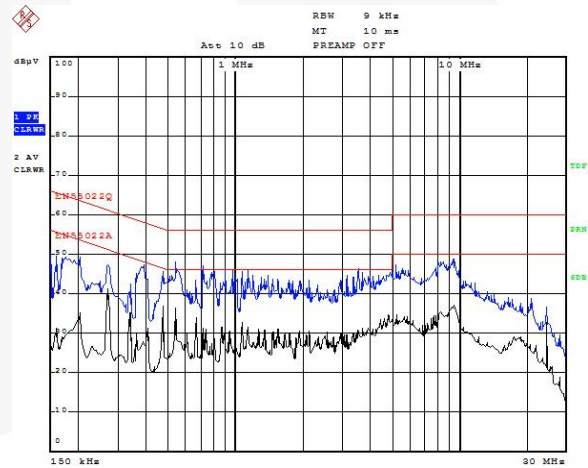

Figure 29. Conduction Neutral at 230V_{AC} Full Load

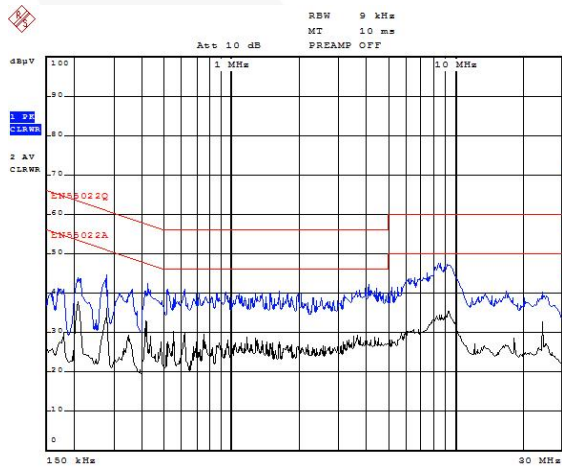

Figure 30. Conduction Line at 115V_{AC} 75% Load

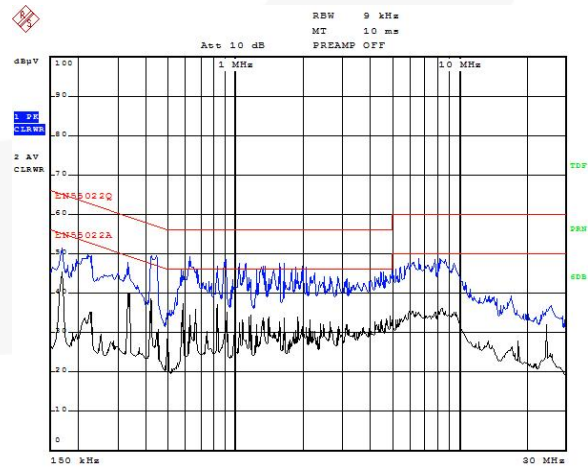
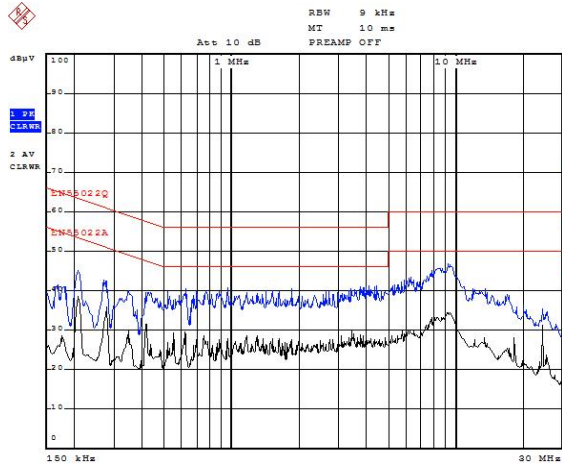
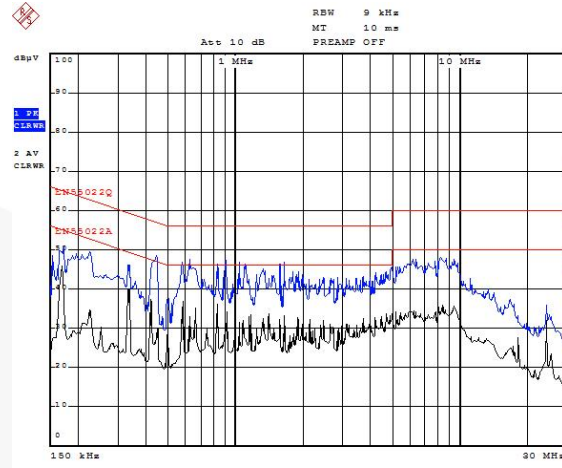

Figure 31. Conduction Line at 230V_{AC} 75% Load



Date: 29.AUG.2011 16:01:03

Figure 32. Conduction Neutral at 115V_{AC} 75% Load



Date: 29.AUG.2011 16:04:59

Figure 33. Conduction Neutral at 230V_{AC} 75% Load

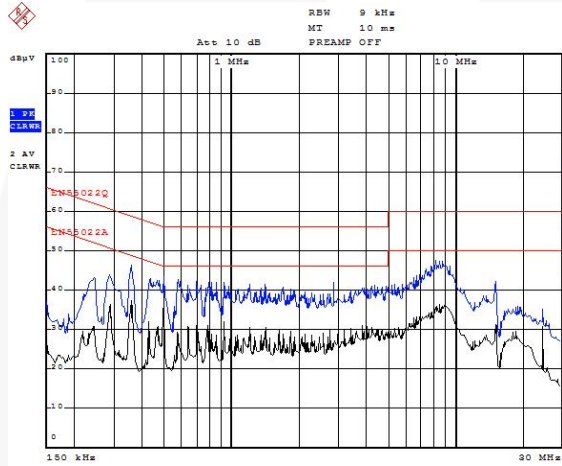

Date: 29.AUG.2011 17:16:27

Figure 34. Conduction Line at 115V_{AC} 50% Load

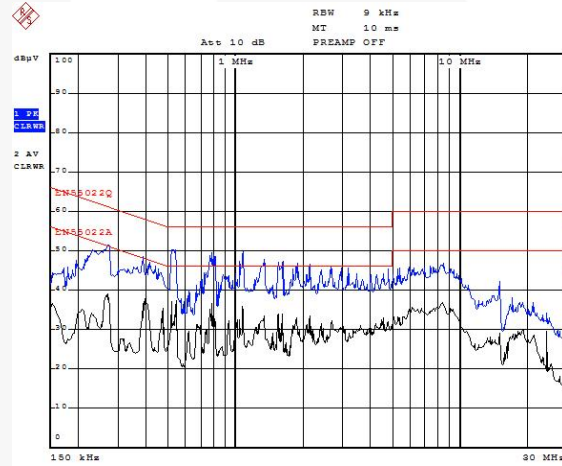

Date: 29.AUG.2011 17:20:36

Figure 35. Conduction Line at 230V_{AC} 50% Load

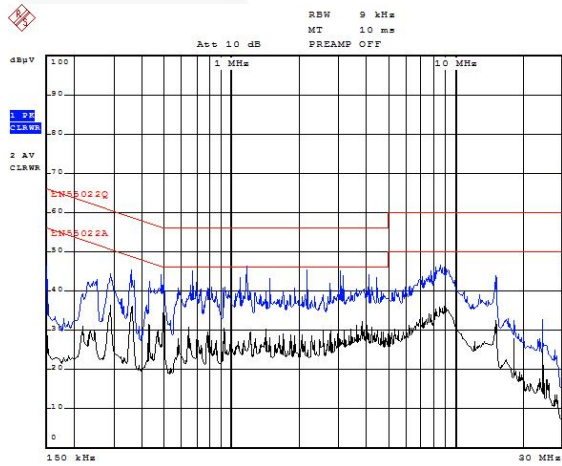

Date: 29.AUG.2011 17:14:16

Figure 36. Conduction Neutral at 115V_{AC} 50% Load

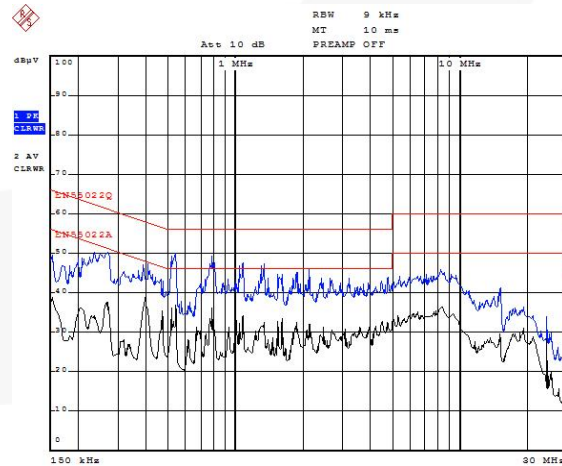

Date: 29.AUG.2011 17:22:33

Figure 37. Conduction Neutral at 230V_{AC} 50% Load

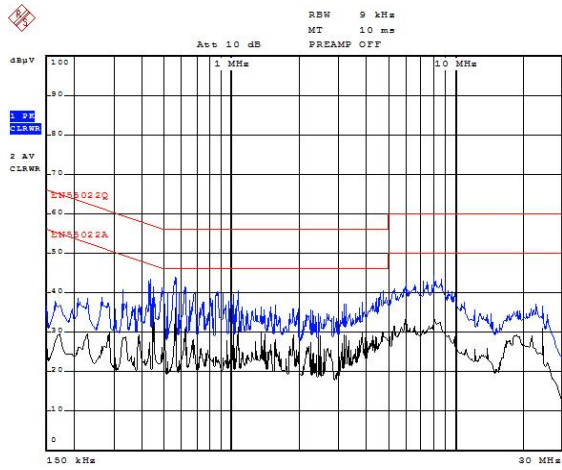

Date: 29.AUG.2011 17:40:09

Figure 38. Conduction Line at 115V_{AC} 25% Load

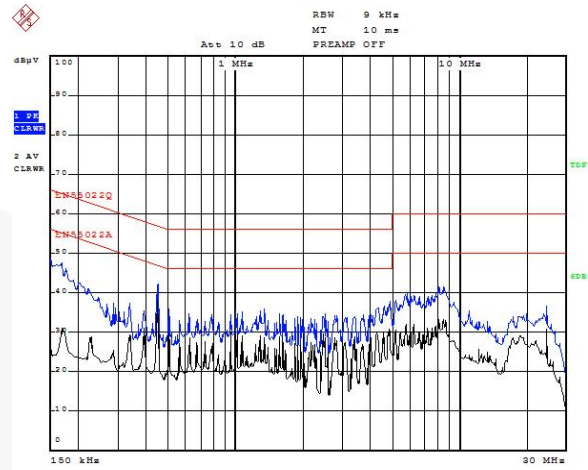

Date: 29.AUG.2011 17:36:12

Figure 39. Conduction Line at 230V_{AC} 25% Load

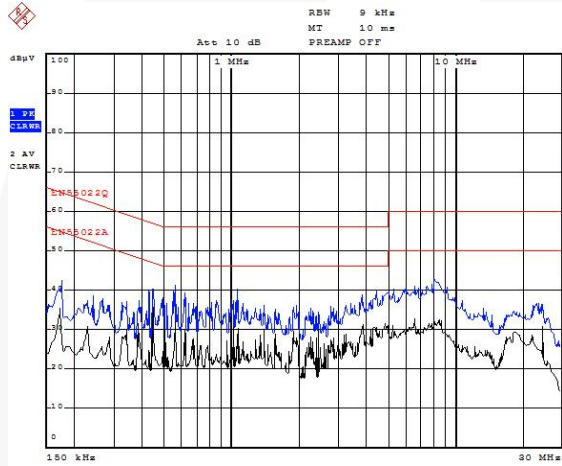

Date: 29.AUG.2011 17:49:58

Figure 40. Conduction Neutral at 115V_{AC} 25% Load

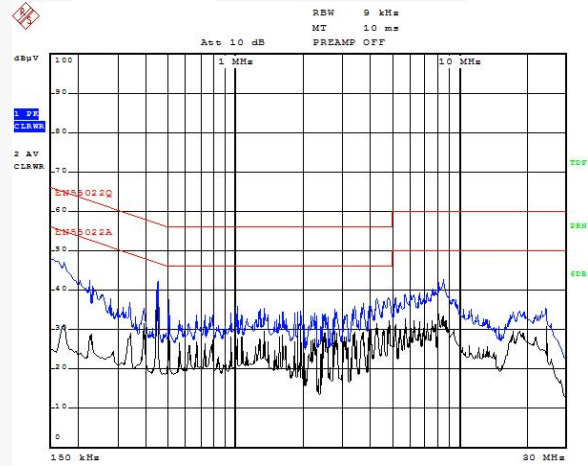

Date: 29.AUG.2011 17:37:59

Figure 41. Conduction Neutral at 230V_{AC} 25% Load

21. Surge Test

Mode	Polarity	Phase	Voltage	Condition
L-PE	±	0°	6KV	PASS
	±	90°		PASS
	±	180°		PASS
	±	270°		PASS
N-PE	±	0°	6KV	PASS
	±	90°		PASS
	±	180°		PASS
	±	270°		PASS
L-N	±	0°	1KV	PASS
	±	90°		PASS
	±	180°		PASS
	±	270°		PASS

22. ESD Test

Air Discharge (16.5KV)		Contact Discharge (8.8KV)	
PASS	PASS	PASS	PASS

23. System Reliability Test

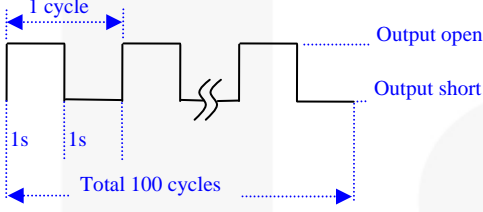
No.	Test Item	Test Condition	Test Result
1.	Output Open/Short	<p>$V_{IN} = 264V_{AC}$ $T_A = \text{Room Temperature}$ Output – Press output short-circuit protect for 1 second and release for 1 second for one test cycle (see Figure 42). Continue test cycle is 100 cycles.</p>  <p style="text-align: center;">Figure 42. Output Open / Short Diagram</p>	PASS
2.	Power Supply ON/OFF	<p>$V_{IN} = \text{Power on 10s (264V}_{AC}\text{); power off 30s}$ Output = Full Load $T_A = 95^\circ\text{C}$ Test Time = 72 Hours</p>	PASS
3.	High-Temperature / High-Humidity Operation	<p>① $V_{IN} = 90V_{AC}$ ② $V_{IN} = 264V_{AC}$ Output = Full Load $T_A = 80^\circ\text{C}$ Humidity = 90% Test Time = ① 24 Hours ② 24 Hours</p>	PASS PASS
4.	Low-Temperature Operation	<p>① $V_{IN} = 90V_{AC}$ ② $V_{IN} = 264V_{AC}$ $T_A = -5^\circ\text{C}$ Test Time = ① 24 Hours ② 24 Hours</p>	PASS PASS
5.	Low-Temperature Starting Test	<p>① $V_{IN} = 90V_{AC}$ ② $V_{IN} = 264V_{AC}$ Output = Full Load Startup After $5^\circ\text{C} / 2 \text{ Hours}$</p>	PASS PASS

24. Photographs



Figure 43. Top View

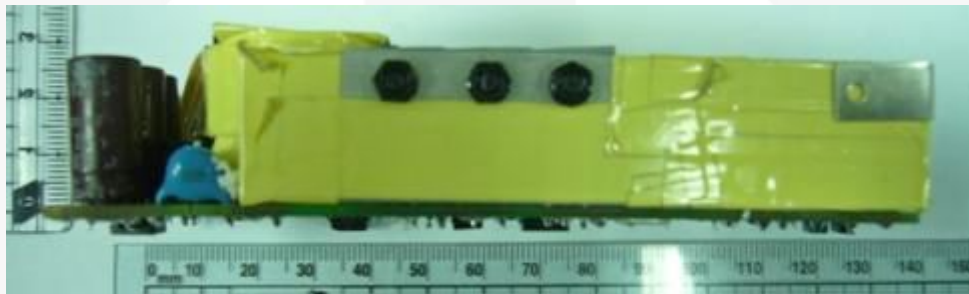

Figure 44. Lateral View

26. Board Layout

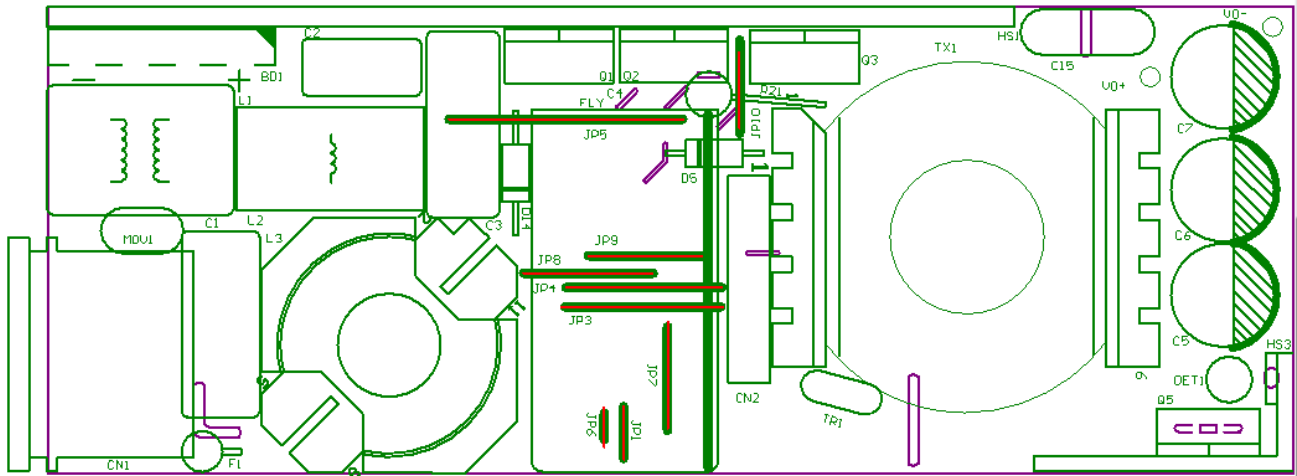

Figure 46. Evaluation Board Layout (Mother Board), Top Overlay

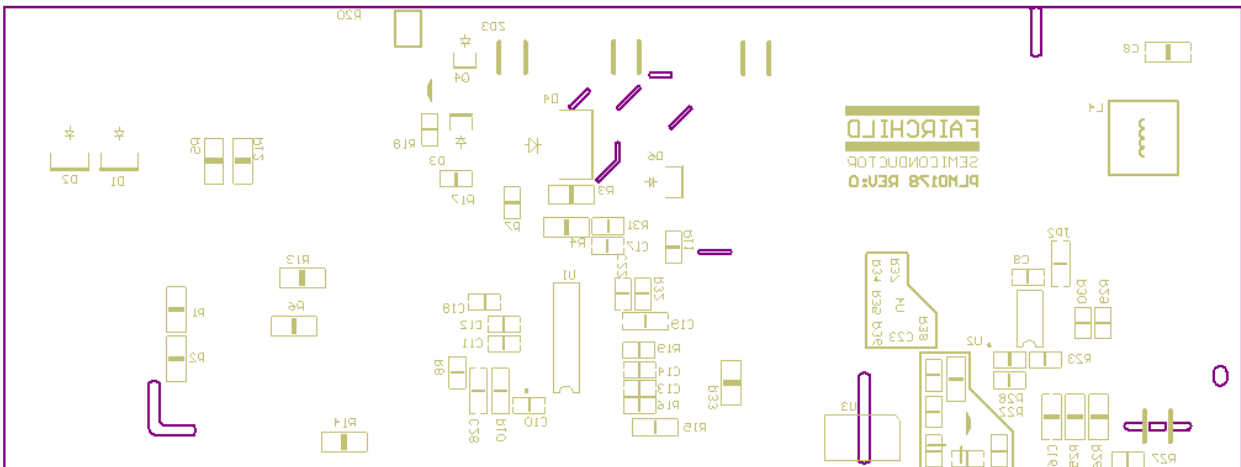

Figure 47. Evaluation Board Layout (Mother Board), Bottom Overlay

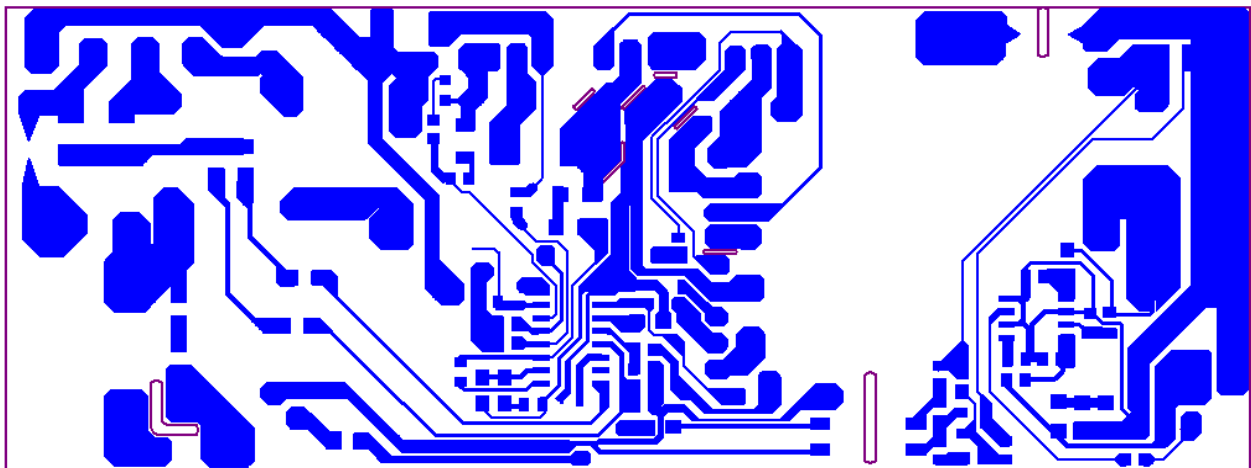

Figure 48. Evaluation Board Layout (Mother Board), Bottom Layer

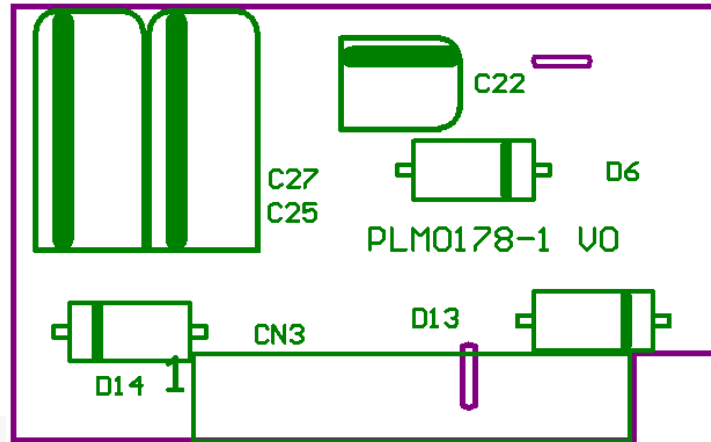

Figure 49. Evaluation Board Layout (Daughter Card), Top Overlay

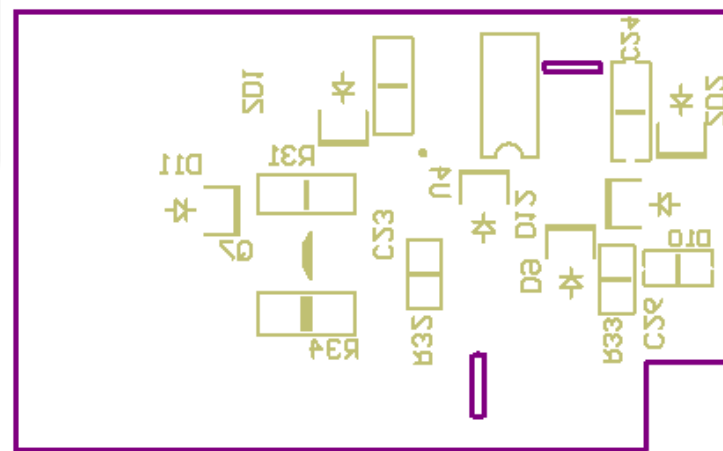

Figure 50. Evaluation Board Layout (Daughter Card), Bottom Overlay

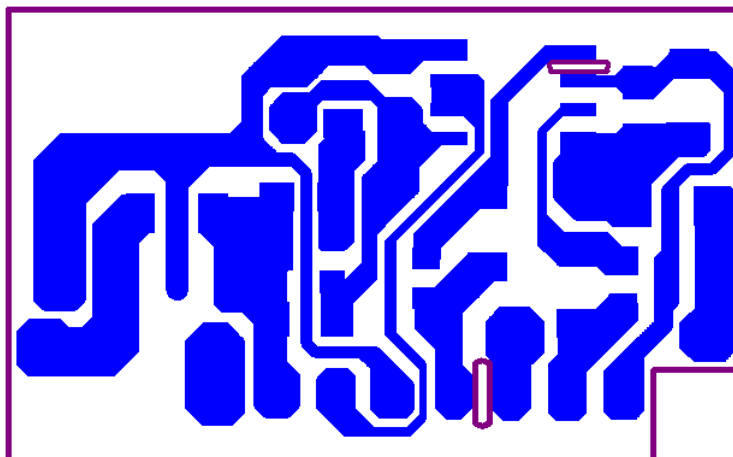

Figure 51. Evaluation Board Layout (Daughter Card), Bottom Layer

27. Bill of Materials, Main Board

Component	Qty.	Part No.	Manufacturer	Reference
JUMPER WIRE 0.8ψ(mm)	9			JP6 JP1 JP10 JP7 JP9 JP8 JP3 JP4 JP5
AC WIRE 1.5ψ(mm)	1			JP11
Non-Inductive Wire Wound Resistor 1W 0Ω27 ±5%	1			R21
SMD Resistor 0805 0Ω±5%	1			R27
SMD Resistor 0805 49.9Ω±5%	1			R17
SMD Resistor 0805 150Ω±5%	1			R18
SMD Resistor 0805 220Ω±5%	2			R7 R11
SMD Resistor 0805 330Ω±5%	1			R34
SMD Resistor 0805 560Ω±5%	1			R15
SMD Resistor 0805 1KΩ±5%	1			R36
SMD Resistor 0805 3.6KΩ±5%	1			R19
SMD Resistor 0805 8.25KΩ±1%	1			R23
SMD Resistor 0805 10KΩ±1%	2			R35 R38
SMD Resistor 0805 12.1KΩ±1%	1			R30
SMD Resistor 0805 16.2KΩ±1%	1			R32
SMD Resistor 0805 47.5KΩ±1%	1			R29
SMD Resistor 0805 66.5KΩ±1%	1			R37
SMD Resistor 0805 78.7KΩ±1%	1			R31
SMD Resistor 0805 165KΩ±1%	1			R16
SMD Resistor 0805 220KΩ±1%	1			R22
SMD Resistor 0805 249KΩ±1%	1			R8
SMD Resistor 1206 0Ω±5%	1			JP2
SMD Resistor 1206 49.9Ω±5%	2			R25 R26
SMD Resistor 1206 37.4KΩ±5%	2			R12 R13
SMD Resistor 1206 47.5KΩ±5%	1			R14
SMD Resistor 1206 100KΩ±5%	1			R33
SMD Resistor 1206 1.5MΩ±5%	2			R1 R2
SMD Resistor 1206 4.7MΩ±1%	4			R3 R4 R5 R6
SMD Resistor 2512 0.15 ±1% 2W	1			R20
NTC Thermistor 5ψ 100kΩ	1			TR1
SMD 0805 471P 50V ±10%	2			C11, C12
SMD 0805 102P 50V ±10%	2			C14, C17
SMD 0805 103P 50V ±10%	1			C23
SMD 0805 104P 50V ±10%	1			C9
SMD 0805 224P 50V ±10%	2			C13 C28
SMD 0805 105P 50V ±10%	1			C18
SMD 1206 102P 100V ±10%	1			C16
SMD 1206 103P 50V ±10%	1			C19

Component	Qty.	Part No.	Manufacturer	Reference
SMD 1206 104P 50V ±10%	1			C8
Electrolytic Cap. 820μ 25V 105°C	3	KZH	NCC	C5 C6 C7
Electrolytic Cap. 120μ 420V 105°C	1	PAG	NCC	C4
MPE Cap. 0.33μ 450V ±10%	1			C2
MPE Cap. 1μ 450V ±10%	1			C3
X1 Cap. 0.47μ 250V ±20%	1			C1
Y1 Cap. 102P/250V ±20%	1			C15
Bridge Rectifier 6A/600V	1	GBU6J	Fairchild	BD1
Ultra-Fast Diode 3A/600V DO-214AB	1	ES3J	Fairchild	D4
Ultra-Fast Diode 1A/600V DO-214AC	1	ES1J	Fairchild	D6
Ultra-Fast Diode 1A/1000V DO-41	1	UF1007	Fairchild	D5
General-Purpose Rectifier 1A/1000V	2	S1M	Fairchild	D1 D2
Schottky Diode 1A/40V DO-41	1	1N5819	Fairchild	D14
SMD Diode	1	LL4148		D3
SMD Zener Diode 1/2W 30V	1	MMSZ5256B	Fairchild	ZD3
PNP Transistor SOT-23	1	MMBT2907A	Fairchild	Q4
MOSFET 600V/16A TO-220	3	FCP16N60	Fairchild	Q1 Q2 Q3
MOSFET 75V/235A TO-220	1	FDP032N08	Fairchild	Q5
Filter Inductor	1	TRN0184	SEN HUEI	L2
Common Mode Choke	1	FS1606H-1LB	SHING GA	L1
Choke 47nH	1	FP2-S047-R	COOPER Bussmann	L4
PFC Inductor RM10 400μH	1	TRN0321	SEN HUEI	L3
PWM transformer POT-3319 1000μH	1	TRN0320	SEN HUEI	TX1
Shunt Regulator ±2%	1	KA431SAMF2	Fairchild	U4
Phototransistor Output Opto-coupler SMDIP-B	1	FOD817B	Fairchild	U3
FUSE GLASS 4A/250V QUICK	1			F1
Varistor 7ψ 470V	1	471KD07		MOV1
AC Inlet 2P 90°	1			CN1
Heat Sink (Primary)	1	MCH0646		HS1
Heat Sink (Secondary)	1	MCH0637		HS2
IC FAN6920MRMY	1		Fairchild	U1
IC FAN6204MY	1		Fairchild	U2
PCB PLM0178 V0	1			PCB
FAN7382 Card	1			CN2

27.1. Bill of Materials, FAN7382 Card

Component	Qty.	Part No.	Manufacturer	Reference
SMD Resistor 0805 59Ω±1%	2			R32 R33
SMD Resistor 1206 0Ω±5%	3			R34 D10 D11
SMD 1206 104P 50V ±10%	1			C24
SMD 1206 105P 50V ±10%	1			C23
SMD Diode	2	LL4148		D9 D12
SMD Zener Diode 1/2W 20V	1			ZD2
Fast Recovery Rectifier 1A/200V, DO-41	2	1N4935	Fairchild	D13 D14
Ultra Fast Diode 1A/1000V DO-41	1	UF1007	Fairchild	D6
Electrolytic Cap. 47μ 50V 105°C	2	LHK	JACKCON	C25 C27
PIN HDR 1*8P 2.54mm 90°	1			CN3
IC FAN7382MX	1		Fairchild	U4
PCB PLM0178-1 V0	1			PCB

28. Specification Approval

Customer	SYSTEM GENERAL CORP.			P/N:	FS1606H-1LB
DATE	11/10/2009	Version	A	Page	1/1

1. OUT LINE DIMENSION:

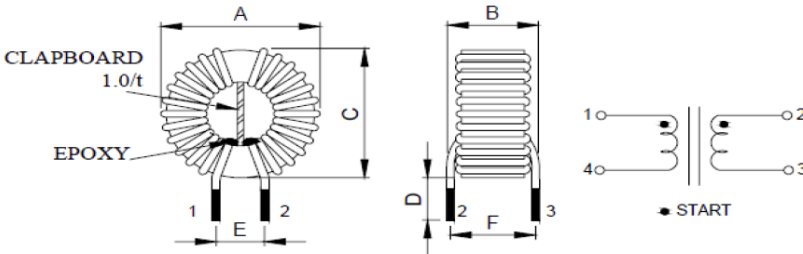

SPEC.(mm)	
A	21.0 MAX
B	13.0 MAX
C	20.0 MAX
D	10.0±1.0
E	10.0±1.0
F	10.0±1.0

NOTE: 1、进出线与隔板之结合处需点 G-9008 黑胶固定;





2.WINDING & ELECTRONICS: (150KHz, 0.1V)25°C

ITEM	START	FINISH	MATERIAL	TURNS	COLOR	INDUCTANCE	DCR(mΩ)
N1	1	4	2UEW φ0.4*1P	50TS	N	11.5 mH MIN	210.0 MAX
N2	2	3	2UEW φ0.4*1P	50TS	N		

3.TEST INSTRUMENTS: L.C.R.CH-1062A;502B

4.MATERIAL LIST:

NO	ITEM	MATERIAL	SUPPLIER	UL NO.	CLASS
1	CORE	FS1606H-1LB	FRIENDLHIP ELECTRONICS CO.,LTD		
2	WIRE	2UEW	PACIFIC ELECTRIC WIRE & CABLE CO.,LTD.	E201757	130°C
3	EPOXY	G-9008	DONGGUANCITYGUDAKELECTRONICMATERI ALS CO.,LTD.		
4	CLAPBOARD	FR-4	HUIZHOUJIANYONGINDUSTRIALPRODUCTCO. .LTD	E123995	150°C

APPROVED	RECHECKED	CHECKED	DRAWN
			

Customer	SYSTEM GENERAL CORP.			P/N:	TRN-0184
DATE	04/02/2004	Version	A	Page	1/1

1.DIMENSION :

UNIT : mm

A	19.5 max
B	11.5.max
C	10 ± 1
D	5 ± 1
E	φ0.6±0.1

2.RLECTRICL SPCIFICATON : at 1KHz,0.25V

2.1 INSDUCTANCE : L1=400 uH ± 20%

2.2 DC RESISTANCE : R1=0.15 mOhm max

2.3 TURN & WIRE : N1 : φ0.60x84TS(2UEW)

MATERIALS LIST :

COMPONENTM	MAT'L	MANUFACTURE	UL FILE NO.
1.CORE	6026 Or equal	core 6026 TECH-MOUNT.	
2.WIRE	UEW-B	Chuen Yih wire co.,ltd	E154709(S)
	UEW-2	Jung Shing wire co.,ltd	E79029(S)
	UEW	Tai-1 electric wire & cable co.,ltd	E85640(S)

UNIT	m/m	DRAWN	CHECK	TITLE	
TEL	(02)29450588	Ci wun Chen	Guo long Huang	IDENT N O.	TRN-0184
FAX	(02)29447647	SEN HUEI INDUSTRIAL CO.,LTD.		D W G N O.	I0051
No.26-1, Lane 128, Sec. 2, Singnan Rd., Jhonghe City, Taipei County 235, Taiwan (R.O.C.)					

Customer	SYSTEM GENERAL CORP.			P/N:	TRN-0321
DATE	08/24/2011	Version	A	Page	1/5
1.DIMENSION					
UNIT	m/m	DRAWN	CHECK	TITLE	
TEL	(02)29450588	Ci wun Chen	Guo long Huang	IDENT N O.	TRN-0321
FAX	(02)29447647	SEN HUEI INDUSTRIAL CO.,LTD.		D W G N O.	
No.26-1, Lane 128, Sec. 2, Singnan Rd., Jhonghe City, Taipei County 235, Taiwan (R.O.C.)					

Customer	SYSTEM GENERAL CORP.			P/N:	TRN-0321
DATE	08/24/2011	Version	A	Page	2/5

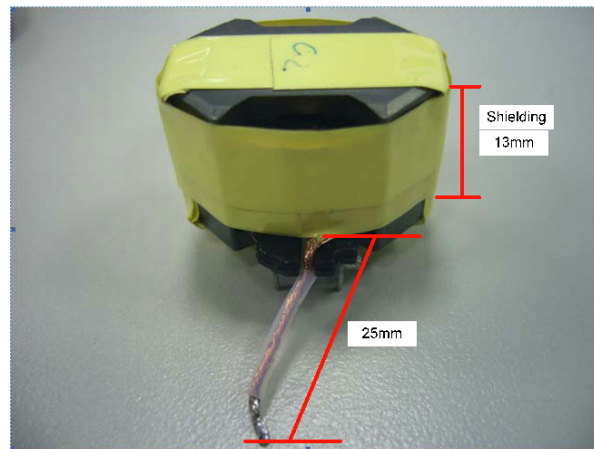

Note :

1. Remove pin 1,3,5,6,7,10 and 12
2. Reserve a short length of fly-wire of N1 winding at the starting point, where is between pin 2 and pin 11.
3. As shown in picture, the length of fly-wire is 25mm. The fly-wire is covered with insulated tube.
4. The width of external shielding is at least greater than 13mm. Make sure the external shielding forms a closed loop by soldering. Connect the shielding to pin 11 with cooper wire. Cover the shielding with 2 to 3 layers of 14mm insulated tape.

UNIT	m/m	DRAWN	CHECK	TITLE	
TEL	(02)29450588	Ci wun Chen	Guo long Huang	IDENT N O.	TRN-0321
FAX	(02)29447647	SEN HUEI INDUSTRIAL CO.,LTD.		D W G N O.	
No.26-1, Lane 128, Sec. 2, Singnan Rd., Zhonghe City, Taipei County 235, Taiwan (R.O.C.)					

Customer	SYSTEM GENERAL CORP.			P/N:	TRN-0321
DATE	08/24/2011	Version	A	Page	3/5

2.SCHEMATIC :

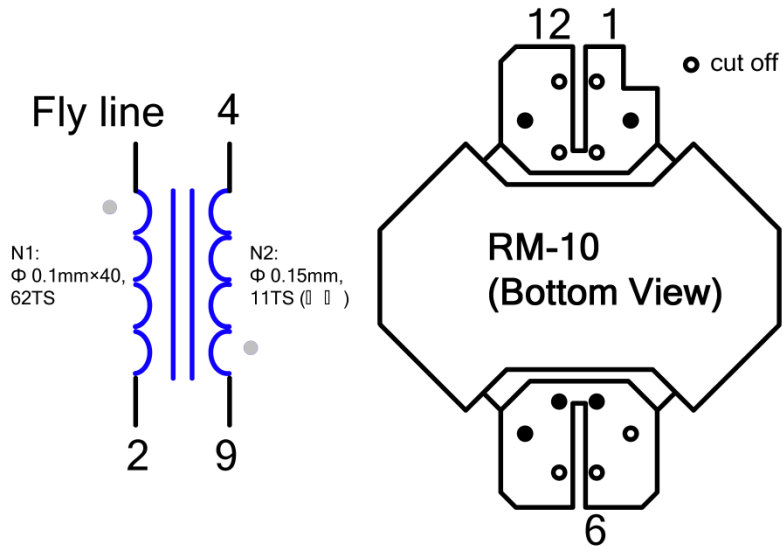

2.1SCHEMATIC :

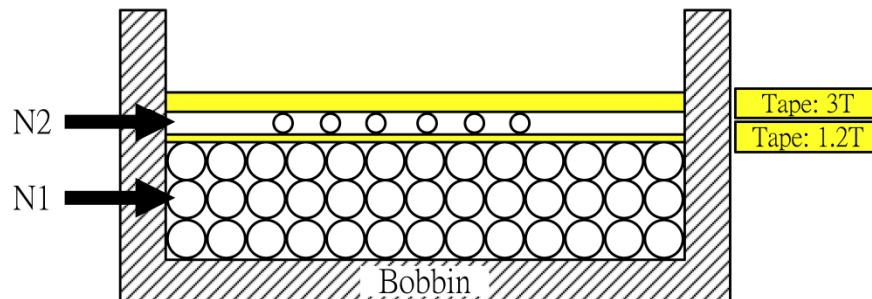

UNIT	m/m	DRAWN	CHECK	TITLE	
TEL	(02)29450588	Ci wun Chen	Guo long Huang	IDENT N O.	TRN-0321
FAX	(02)29447647	SEN HUEI INDUSTRIAL CO.,LTD.		D W G N O.	
No.26-1, Lane 128, Sec. 2, Singnan Rd., Jhonghe City, Taipei County 235, Taiwan (R.O.C.)					

Customer	SYSTEM GENERAL CORP.			P/N:	TRN-0321
DATE	08/24/2011	Version	A	Page	4/5
<p>3.ELECTRICAL SPECIFICATION :</p> <p>3.1 Inductance test : at 1KHz ,1V P(2-Fly line) : 400 uH ± 10%</p> <p>3.2 DC Resistance test at 25 ° C P(2-Fly line) : 0.37Ohmo max</p> <p>3.3 Hi-pot test :</p> <p>AC 3.0 KV/60Hz/0.5mA hi-pot for one minute between pri to sec. AC 1.5 KV/60Hz/0.5mA hi-pot for one minute between pri to core.</p> <p>3.4 Insulation test :</p> <p>The insulation resistance is between pri to sec and windings to core measured by DC 500V, must be over 100 MOhm.</p> <p>3.5 Terminal strength :</p> <p>1.0 Kg on terminals for 30 seconds, test the breakdown.</p>					
UNIT	m/m	DRAWN		CHECK	
TEL	(02)29450588	Ci wun Chen		Guo long Huang	IDENT N O. TRN-0321
FAX	(02)29447647	SEN HUEI INDUSTRIAL CO.,LTD.		D W G N O.	
No.26-1, Lane 128, Sec. 2, Singnan Rd., Jhonghe City, Taipei County 235, Taiwan (R.O.C.)					

Customer	SYSTEM GENERAL CORP.			P/N:	TRN-0321
DATE	08/24/2011	Version	A	Page	5/5
MATERIALS LIST : (UL: E196468)					
COMPONENTM	MAT'L	MANUFACTURE		FILE NO.	
1.Bobbin	Phenolic 94v-0,T373J,150°C	RM-10			
2.Core	-	RM-10			
3.Wire	UEWE 130°C	Tai-I electric wire & cable CO., Ltd.		E85640 (S)	
	UEW-2 130°C	Jung Shing wire CO., Ltd.		E174837	
	UEW-B 130°C	Chuen Yih wire CO., Ltd.		E154709 (S)	
4.Varnish	BC-346A 180°C	John C Dolph CO., Ltd.		E51047 (M)	
	468-2FC 130°C	Ripley resin engineering co inc.		E81777 (N)	
5.Tape 0.025tmm	Polyester 3M #1350 130°C	Minnesota mining & MFG CO., Ltd.		E17385 (N)	
	#31CT 130°C	Nitto denko CORP.		E34833 (M)	
6.Tube	Teflon tube TFS 600V,200°C	Great holding industries CO., Ltd.		E156256 (S)	
7.Terminals	Tin coated- Copper wire	Will for special wire CORP.			
8.Shield	Copper foil	Hitachi cable ltd. (copper foil : 0.025x10mm)			
UNIT	m/m	DRAWN	CHECK	TITLE	
TEL	(02)29450588	Ci wun Chen	Guo long Huang	IDENT N O.	TRN-0321
FAX	(02)29447647	SEN HUEI INDUSTRIAL CO.,LTD.		D W G N O.	
No.26-1, Lane 128, Sec. 2, Singnan Rd., Jhonghe City, Taipei County 235, Taiwan (R.O.C.)					

Customer	SYSTEM GENERAL CORP.			P/N:	TRN-0320
DATE	08/24/2011	Version	A	Page	1/5
1.DIMENSION :					
UNIT	m/m	DRAWN	CHECK	TITLE	
TEL	(02)29450588	Ci wun Chen	Guo long Huang	IDENT N O.	TRN-0321
FAX	(02)29447647	SEN HUEI INDUSTRIAL CO.,LTD.		DW G N O.	
No.26-1, Lane 128, Sec. 2, Singnan Rd., Jhonghe City, Taipei County 235, Taiwan (R.O.C.)					

Customer	SYSTEM GENERAL CORP.			P/N:	TRN-0320
DATE	08/24/2011	Version	A	Page	2/5

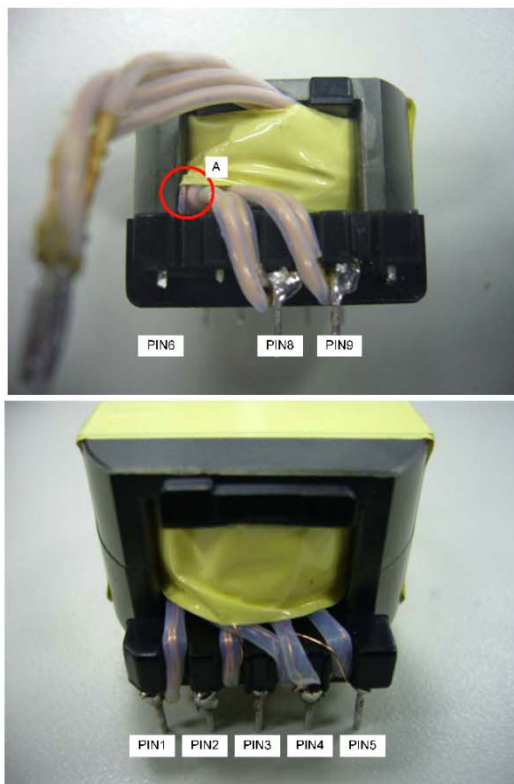

Note :

1. Use pin 6 to be the temporarily starting point of N1 winding. Connect N4 and N1 winding together. After N6 winding is finished, cover N6 with 1.2 turns of insulated tape. Put the contact node of N4 and N1 to point A, as shown in the picture above. Finally, cover the contact node with 3 turns of insulated tape.
2. As shown in the picture, the length of fly-wire requires 4.2cm
3. As shown in the picture, insulated tube is required to cover the fly-wire.
4. Cut off pin 6,7,10

UNIT	m/m	DRAWN	CHECK	TITLE	
TEL	(02)29450588	Ci wun Chen	Guo long Huang	IDENT N O.	TRN-0321
FAX	(02)29447647	SEN HUEI INDUSTRIAL CO.,LTD.		D W G N O.	
No.26-1, Lane 128, Sec. 2, Singnan Rd., Jhonghe City, Taipei County 235, Taiwan (R.O.C.)					

Customer	SYSTEM GENERAL CORP.			P/N:	TRN-0320
DATE	08/24/2011	Version	A	Page	3/5

2. SCHEMATIC :

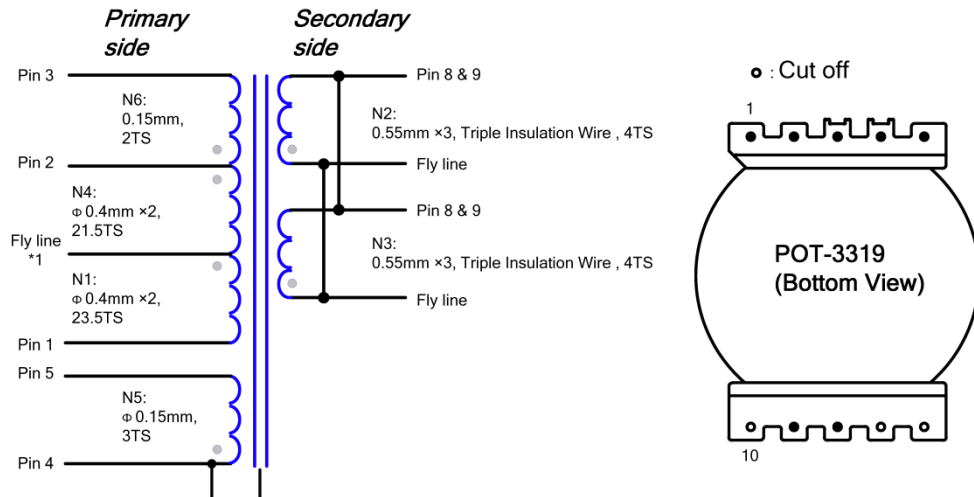

2.1 SCHEMATIC :

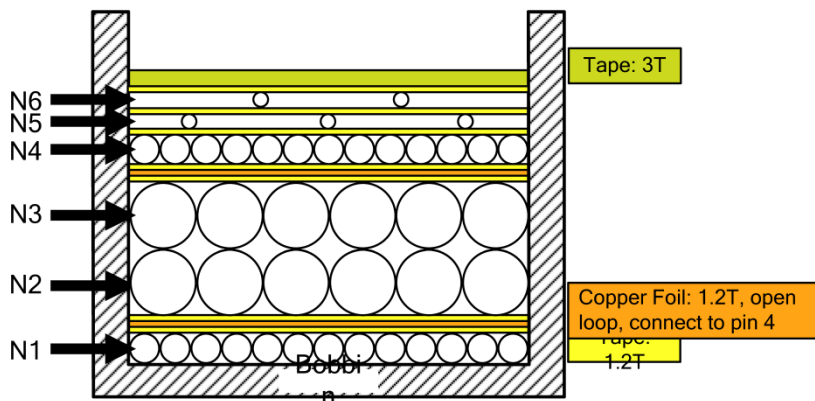

UNIT	m/m	DRAWN	CHECK	TITLE	
TEL	(02)29450588	Ci wun Chen	Guo long Huang	IDENT N O.	TRN-0321
FAX	(02)29447647	SEN HUEI INDUSTRIAL CO.,LTD.		D W G N O.	
No.26-1, Lane 128, Sec. 2, Singnan Rd., Jhonghe City, Taipei County 235, Taiwan (R.O.C.)					

Customer	SYSTEM GENERAL CORP.			P/N:	TRN-0320
DATE	08/24/2011	Version	A	Page	4/5
<p>3.ELECTRICAL SPECIFICATION :</p> <p>3.1 Inductance test : at 1KHz ,1V</p> <p>P(6-5) : 1000 μH\pm 5%</p> <p>3.2 DC Resistance test at 25 ° C</p> <p>P(6-5) : 1.07 Ohmo max</p> <p>3.4 Hi-pot test :</p> <p>AC 3.0K V /60Hz/0.5mA hi-pot for one minute between pri to sec.</p> <p>AC 1.5K V /60Hz/0.5mA hi-pot for one minute between pri to core.</p> <p>3.5 Insulation test :</p> <p>The insulation resistance is between pri to sec and windings to core measured by DC 500V, must Be over 100 MOhm.</p> <p>3.6 Terminal strength :</p> <p>1.0 Kg on terminals for 30 seconds, test the breakdown.</p>					
UNIT	m/m	DRAWN	CHECK	TITLE	
TEL	(02)29450588	Ci wun Chen	Guo long Huang	IDENT N O.	TRN-0321
FAX	(02)29447647	SEN HUEI INDUSTRIAL CO.,LTD.		D W G N O.	
No.26-1, Lane 128, Sec. 2, Singnan Rd., Jhonghe City, Taipei County 235, Taiwan (R.O.C.)					

Customer	SYSTEM GENERAL CORP.			P/N:	TRN-0320
DATE	08/24/2011	Version	A	Page	5/5
MATERIALS LIST :					
COMPONENTM	MAT'L	MANUFACTURE		FILE NO.	
1.Bobbin	Phenlic	POT-3319 Taiwan Shulin Exterprise Co. Ltd.		E5981(S)	
2.Core	PC-44,BH2,2E6 3C85,NC-2H	Ferrite core POT-3319 TDK Tokin. Tomita.Philip.Nicera.			
3.Wire	UEWE 130°C	Tai-I electric wire & cable CO., Ltd.		E85640 (S)	
	UEW-2 130°C	Jung Shing wire CO., Ltd.		E174837	
	UEW-B 130°C	Chuen Yih wire CO., Ltd.		E154709 (S)	
4.Varnish	BC-346A 180°C	John C Dolph CO., Ltd.		E51047 (M)	
	468-2FC 130°C	Ripley resin engineering co inc.		E81777 (N)	
5.Tape 0.025tmm	Polyester 3M #1350 130°C	Minnesota mining & MFG CO., Ltd.		E17385 (N)	
	#31CT 130°C	Nitto denko CORP.		E34833 (M)	
6.Tube	Teflon tube TFS 600V,200°C	Great holding industries CO., Ltd.		E156256 (S)	
7.Terminals	Tin coated- Copper wire	Will for special wire CORP.			
8.Shiel	Copper foil	Hitachi cable ltd. (copper foil : 0.025tx3mm+TAPE)			
UNIT	m/m	DRAWN	CHECK	TITLE	
TEL	(02)29450588	Ci wun Chen	Guo long Huang	IDENT N O.	TRN-0321
FAX	(02)29447647	SEN HUEI INDUSTRIAL CO.,LTD.		D W G N O.	
No.26-1, Lane 128, Sec. 2, Singnan Rd., Jhonghe City, Taipei County 235, Taiwan (R.O.C.)					

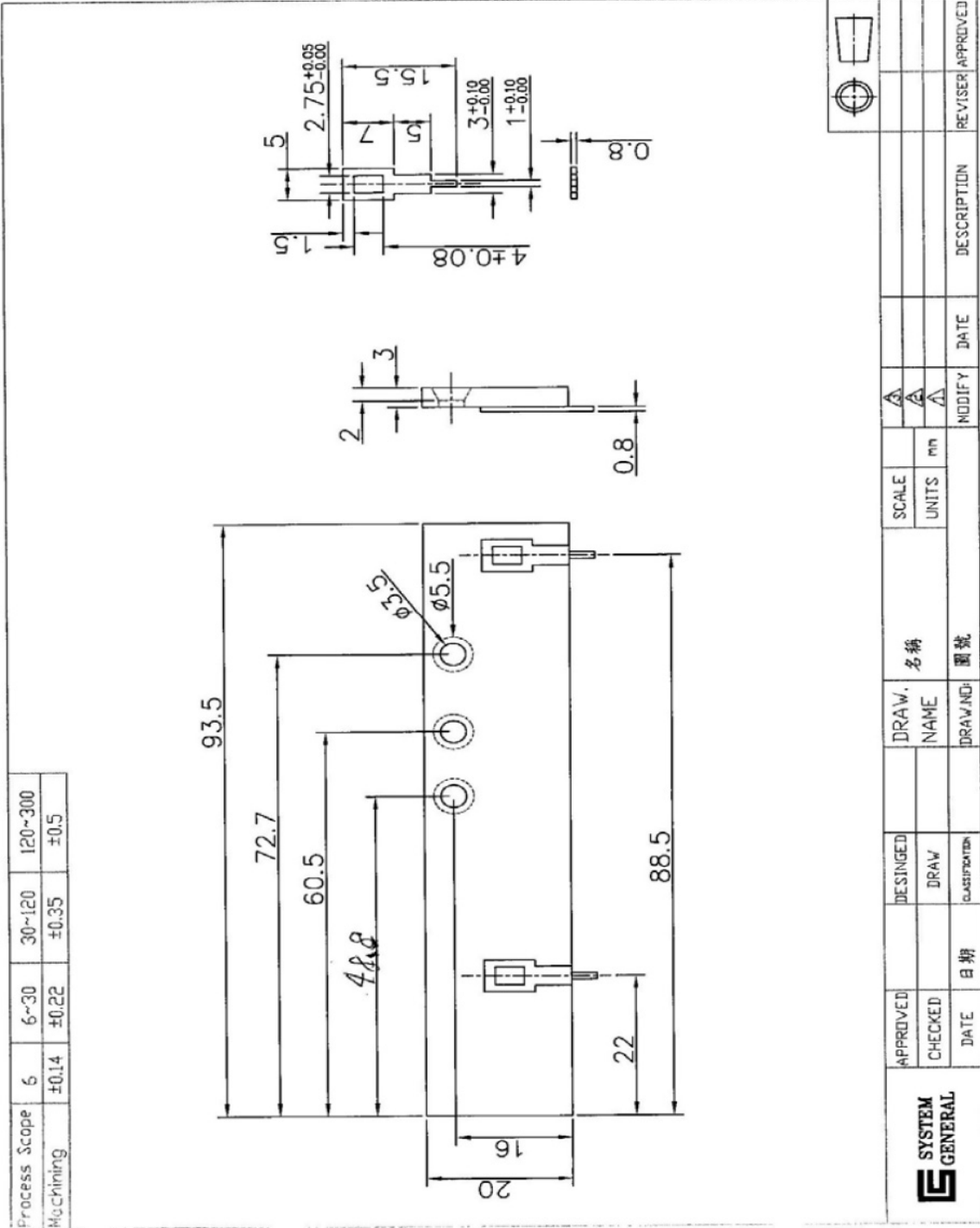

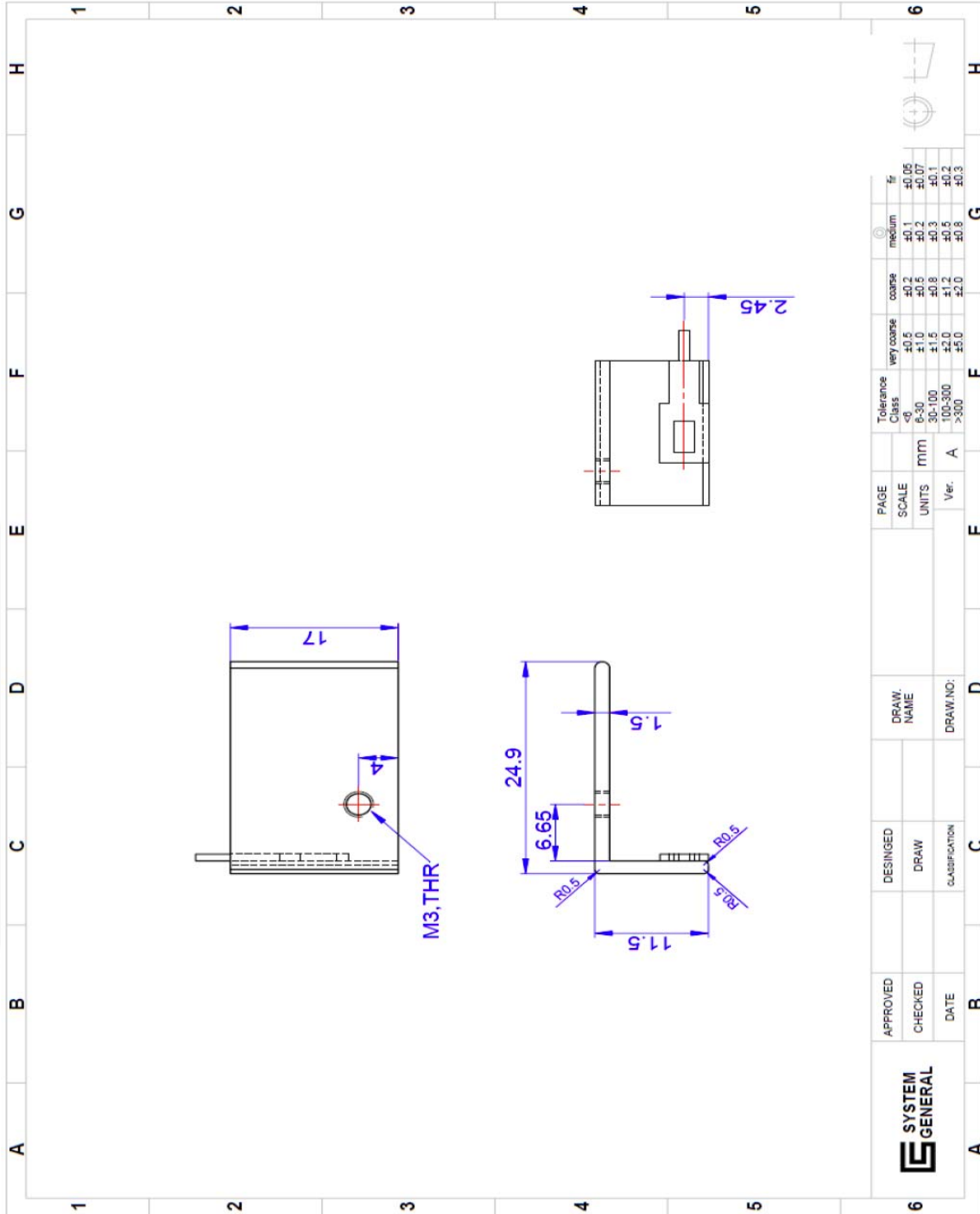

29. Revision History

Rev.	Date	Description
1.0.0	2/2012	Initial release

WARNING AND DISCLAIMER

Replace components on the Evaluation Board only with those parts shown on the parts list (or Bill of Materials) in the Users' Guide. Contact an authorized Fairchild representative with any questions.

This board is intended to be used by certified professionals, in a lab environment, following proper safety procedures. Use at your own risk. The Evaluation board (or kit) is for demonstration purposes only and neither the Board nor this User's Guide constitute a sales contract or create any kind of warranty, whether express or implied, as to the applications or products involved. Fairchild warrants that its products meet Fairchild's published specifications, but does not guarantee that its products work in any specific application. Fairchild reserves the right to make changes without notice to any products described herein to improve reliability, function, or design. Either the applicable sales contract signed by Fairchild and Buyer or, if no contract exists, Fairchild's standard Terms and Conditions on the back of Fairchild invoices, govern the terms of sale of the products described herein.

DISCLAIMER

FAIRCHILD SEMICONDUCTOR RESERVES THE RIGHT TO MAKE CHANGES WITHOUT FURTHER NOTICE TO ANY PRODUCTS HEREIN TO IMPROVE RELIABILITY, FUNCTION, OR DESIGN. FAIRCHILD DOES NOT ASSUME ANY LIABILITY ARISING OUT OF THE APPLICATION OR USE OF ANY PRODUCT OR CIRCUIT DESCRIBED HEREIN; NEITHER DOES IT CONVEY ANY LICENSE UNDER ITS PATENT RIGHTS, NOR THE RIGHTS OF OTHERS.

LIFE SUPPORT POLICY

FAIRCHILD'S PRODUCTS ARE NOT AUTHORIZED FOR USE AS CRITICAL COMPONENTS IN LIFE SUPPORT DEVICES OR SYSTEMS WITHOUT THE EXPRESS WRITTEN APPROVAL OF THE PRESIDENT OF FAIRCHILD SEMICONDUCTOR CORPORATION.

As used herein:

- Life support devices or systems are devices or systems which, (a) are intended for surgical implant into the body, or (b) support or sustain life, or (c) whose failure to perform when properly used in accordance with instructions for use provided in the labeling, can be reasonably expected to result in significant injury to the user.
- A critical component is any component of a life support device or system whose failure to perform can be reasonably expected to cause the failure of the life support device or system, or to affect its safety or effectiveness.

ANTI-COUNTERFEITING POLICY

Fairchild Semiconductor Corporation's Anti-Counterfeiting Policy. Fairchild's Anti-Counterfeiting Policy is also stated on our external website, www.fairchildsemi.com, under Sales Support.

Counterfeiting of semiconductor parts is a growing problem in the industry. All manufacturers of semiconductor products are experiencing counterfeiting of their parts. Customers who inadvertently purchase counterfeit parts experience many problems such as loss of brand reputation, substandard performance, failed applications, and increased cost of production and manufacturing delays. Fairchild is taking strong measures to protect ourselves and our customers from the proliferation of counterfeit parts. Fairchild strongly encourages customers to purchase Fairchild parts either directly from Fairchild or from Authorized Fairchild Distributors who are listed by country on our web page cited above. Products customers buy either from Fairchild directly or from Authorized Fairchild Distributors are genuine parts, have full traceability, meet Fairchild's quality standards for handling and storage and provide access to Fairchild's full range of up-to-date technical and product information. Fairchild and our Authorized Distributors will stand behind all warranties and will appropriately address any warranty issues that may arise. Fairchild will not provide any warranty coverage or other assistance for parts bought from Unauthorized Sources. Fairchild is committed to combat this global problem and encourage our customers to do their part in stopping this practice by buying direct or from authorized distributors.

EXPORT COMPLIANCE STATEMENT

These commodities, technology, or software were exported from the United States in accordance with the Export Administration Regulations for the ultimate destination listed on the commercial invoice. Diversion contrary to U.S. law is prohibited.

U.S. origin products and products made with U.S. origin technology are subject to U.S Re-export laws. In the event of re-export, the user will be responsible to ensure the appropriate U.S. export regulations are followed.