

ON Semiconductor

Is Now

onsemi™

To learn more about onsemi™, please visit our website at
www.onsemi.com

onsemi and **onsemi** and other names, marks, and brands are registered and/or common law trademarks of Semiconductor Components Industries, LLC dba "**onsemi**" or its affiliates and/or subsidiaries in the United States and/or other countries. **onsemi** owns the rights to a number of patents, trademarks, copyrights, trade secrets, and other intellectual property. A listing of **onsemi** product/patent coverage may be accessed at www.onsemi.com/site/pdf/Patent-Marking.pdf. **onsemi** reserves the right to make changes at any time to any products or information herein, without notice. The information herein is provided "as-is" and **onsemi** makes no warranty, representation or guarantee regarding the accuracy of the information, product features, availability, functionality, or suitability of its products for any particular purpose, nor does **onsemi** assume any liability arising out of the application or use of any product or circuit, and specifically disclaims any and all liability, including without limitation special, consequential or incidental damages. Buyer is responsible for its products and applications using **onsemi** products, including compliance with all laws, regulations and safety requirements or standards, regardless of any support or applications information provided by **onsemi**. "Typical" parameters which may be provided in **onsemi** data sheets and/or specifications can and do vary in different applications and actual performance may vary over time. All operating parameters, including "Typicals" must be validated for each customer application by customer's technical experts. **onsemi** does not convey any license under any of its intellectual property rights nor the rights of others. **onsemi** products are not designed, intended, or authorized for use as a critical component in life support systems or any FDA Class 3 medical devices or medical devices with a same or similar classification in a foreign jurisdiction or any devices intended for implantation in the human body. Should Buyer purchase or use **onsemi** products for any such unintended or unauthorized application, Buyer shall indemnify and hold **onsemi** and its officers, employees, subsidiaries, affiliates, and distributors harmless against all claims, costs, damages, and expenses, and reasonable attorney fees arising out of, directly or indirectly, any claim of personal injury or death associated with such unintended or unauthorized use, even if such claim alleges that **onsemi** was negligent regarding the design or manufacture of the part. **onsemi** is an Equal Opportunity/Affirmative Action Employer. This literature is subject to all applicable copyright laws and is not for resale in any manner. Other names and brands may be claimed as the property of others.



High Voltage HB-LED Driver

ON Semiconductor

Device	Application	Input Voltage	Output Current	Topology	I/O Isolation
NCP1034	LED Driver	20-58 V	<60 W	BUCK	NONE

Other Specifications				
	Output 1	Output 2	Output 3	Output 4
Output Voltage	2-46 V	N/A	N/A	N/A
Nominal Output Voltage	36 V	N/A	N/A	N/A
Nominal Input Voltage	48 V	N/A	N/A	N/A
Current Ripple	<30 mA	N/A	N/A	N/A
Output Current	1.3 A	N/A	N/A	N/A
Operation frequency	400 kHz	N/A	N/A	N/A

Efficiency	92%
------------	-----

Circuit Description

This circuit is intended for driving high power LEDs, such as the Cree XLAMP™ series, Lumileds Luxeon™ Rebel and K2 and OSRAM, Golden and Platinum Dragon™ as well as the OSTAR™. Typical application is for example street lighting. It is designed for wide input and output voltage range. An optional dimming PWM input is included. The circuit is based on NCP1034 operation at 400 kHz in a non-isolated configuration.

Key Features

- Buck mode
- Wide input and output operation voltage
- Precise line and load regulation
- Dimming capability
- High operation frequency
- Minimal output current ripple
- Output short circuit protection
- Synchronization capability
- Ceramic capacitors only

DN06047/D

Schematic

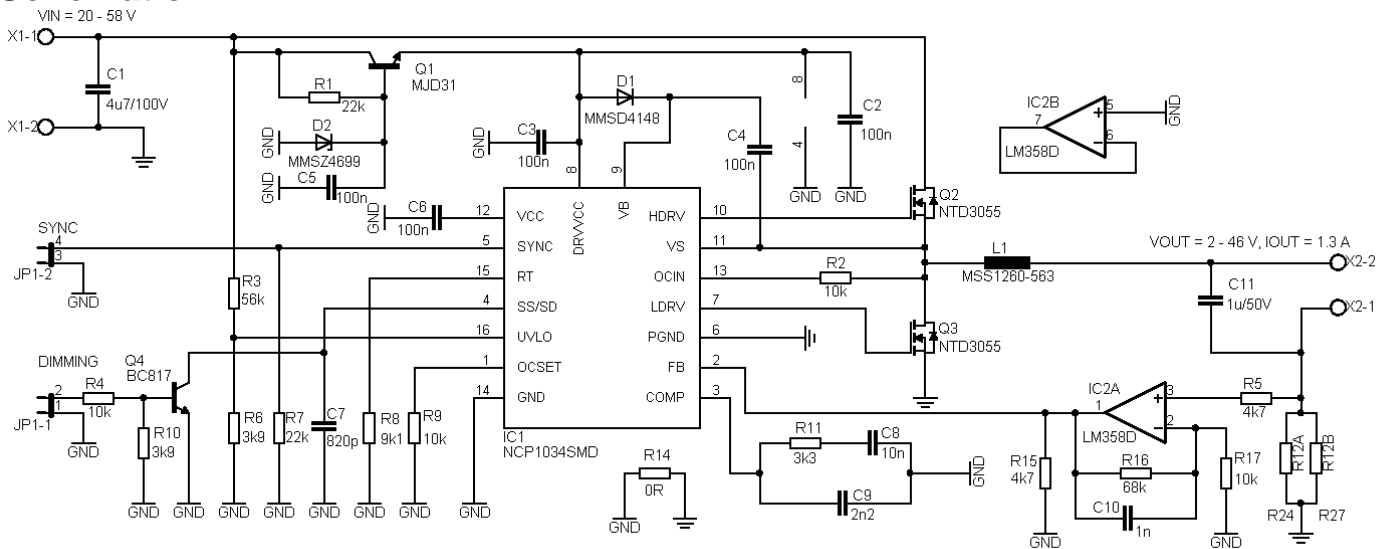

Figure 1 – LED driver schematic

Design Notes

The LED driver is based on typical NCP1034 application except for the feedback path. The feedback voltage is sensed at the current sense resistors in series with the LED string. An Op Amp is used to amplify the voltage drop on current sense resistors. The voltage drop is only 0.16 V against the internal 1.25 V feedback voltage. This results in a reduced power loss from 1.6 W to only 0.2 W at nominal load. The output current can be set by sensing resistors R12A and R12B and by Op Amp gain set resistors R16 and R17.

IC's and Op Amp supply voltage is stabilized by Q1, D2, R1 and C5 circuit. If the input voltage range is narrower then Q1 can be replaced by R1 with higher power loss. Automatic calculation of this and other parameters can be found on web at the following link <http://www.onsemi.com/pub/Collateral/NCP1034%20DESIGN%20WORKSHEET.XLS>.

The dimming signal can be connected to JP1-1. Up to 300 Hz dimming frequency is acceptable. Higher frequency increases the power loss and increases the offset dimming characteristic. The dimming signal can have an amplitude of 0 – 5 V.

External synchronization signal or another NCP1034 can be connected to JP1-2 to decrease EMI.

Measurements

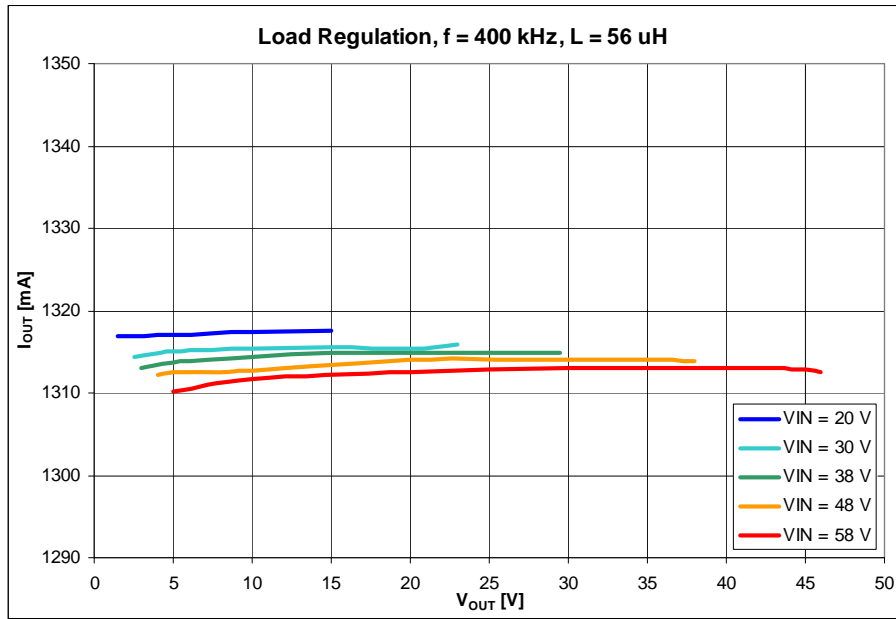

Figure 2 – Load regulation

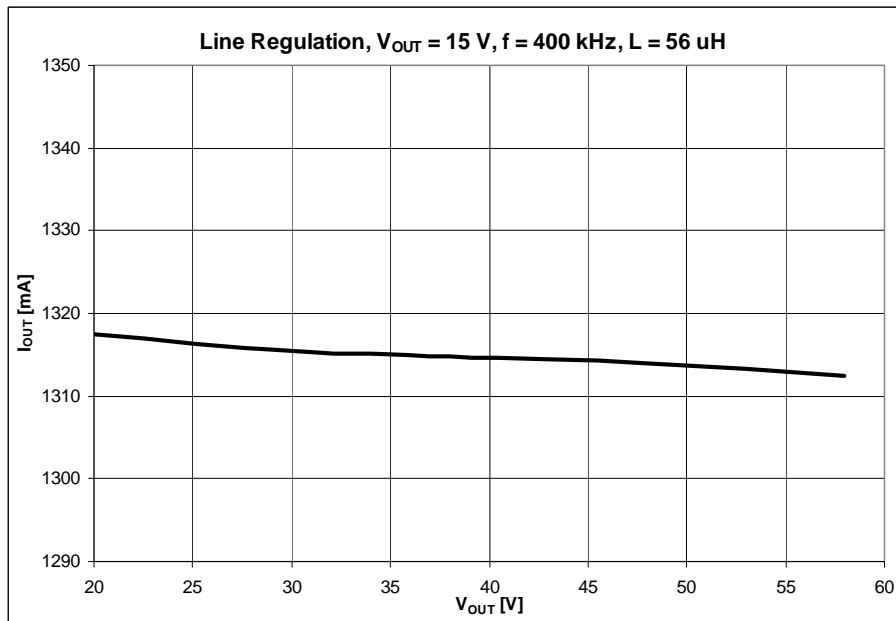

Figure 3 – Line regulation

DN06047/D

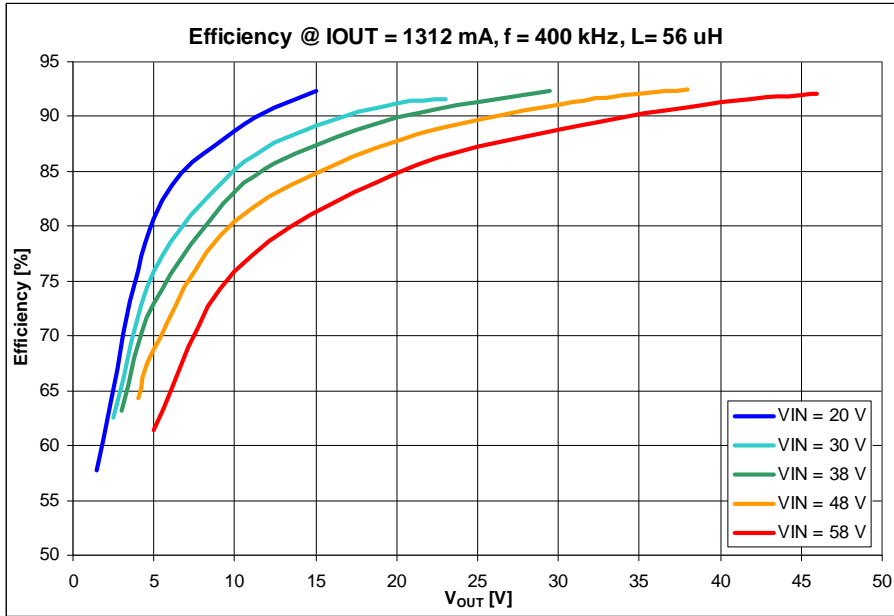

Figure 4 - Efficiency

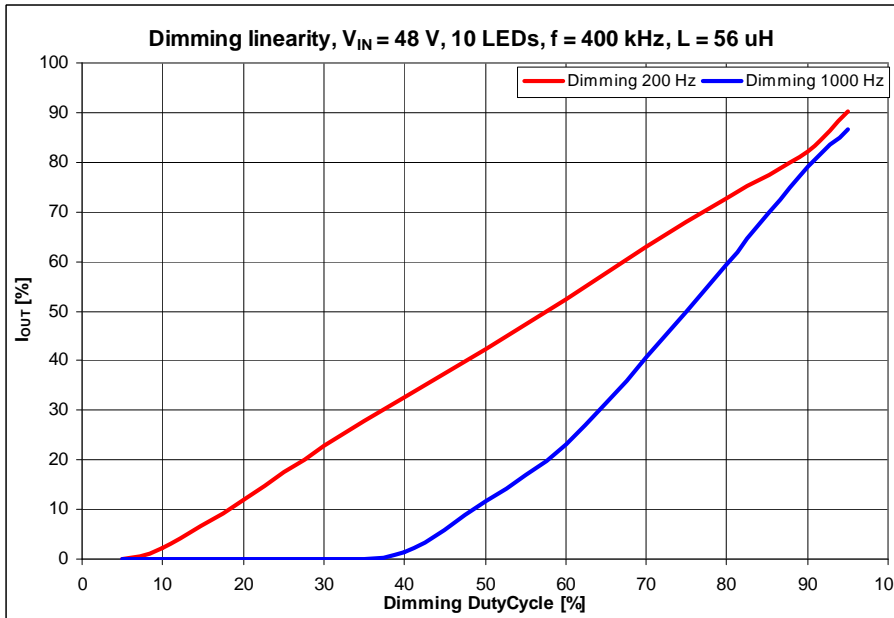

Figure 5 – Dimming linearity

CH1 – Output Voltage

CH2 – Bridge

CH4 – Inductor Current 200mA/div

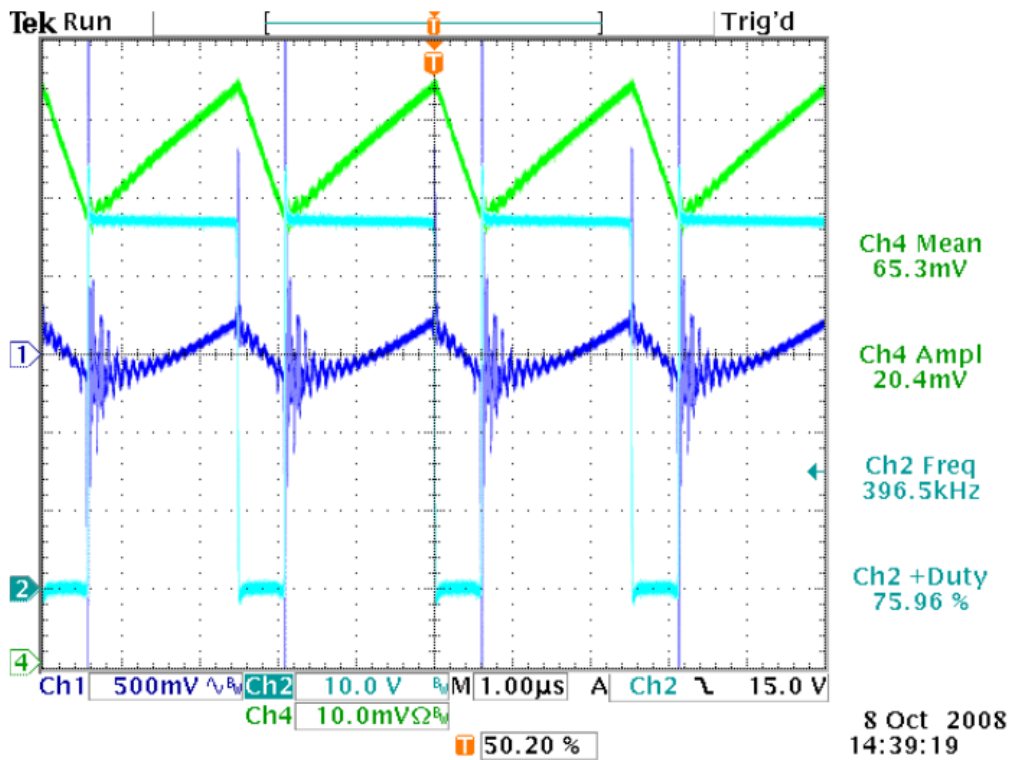

Figure 6 – Inductor current 10 LEDs, $V_{IN} = 48 V$

CH4 – Output capacitor current 100mA/div

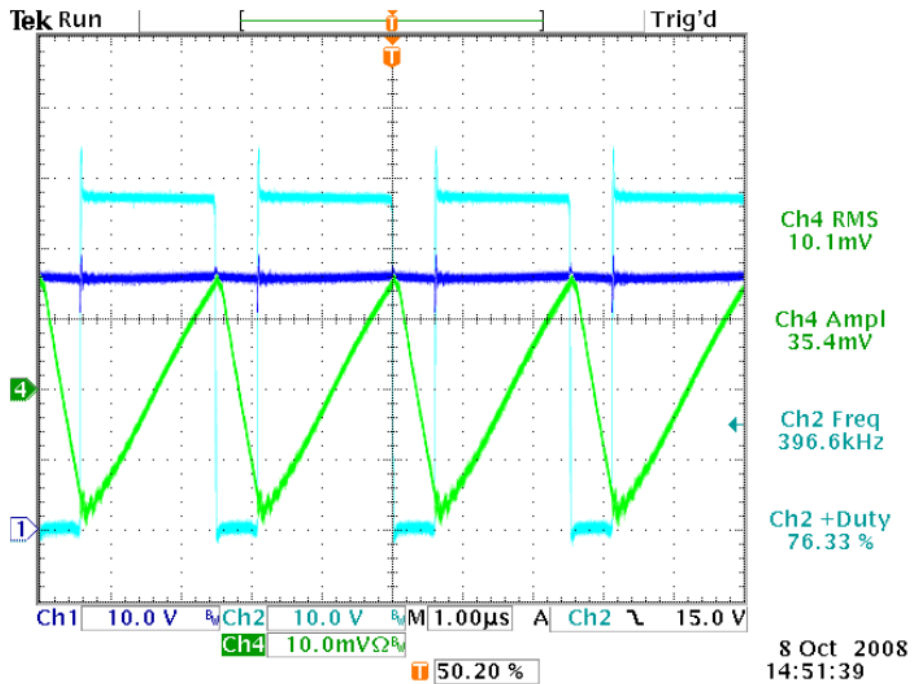

Figure 7 – Output capacitor current 10 LEDs, $V_{IN} = 48 V$

CH4 – Output current 10mA/div

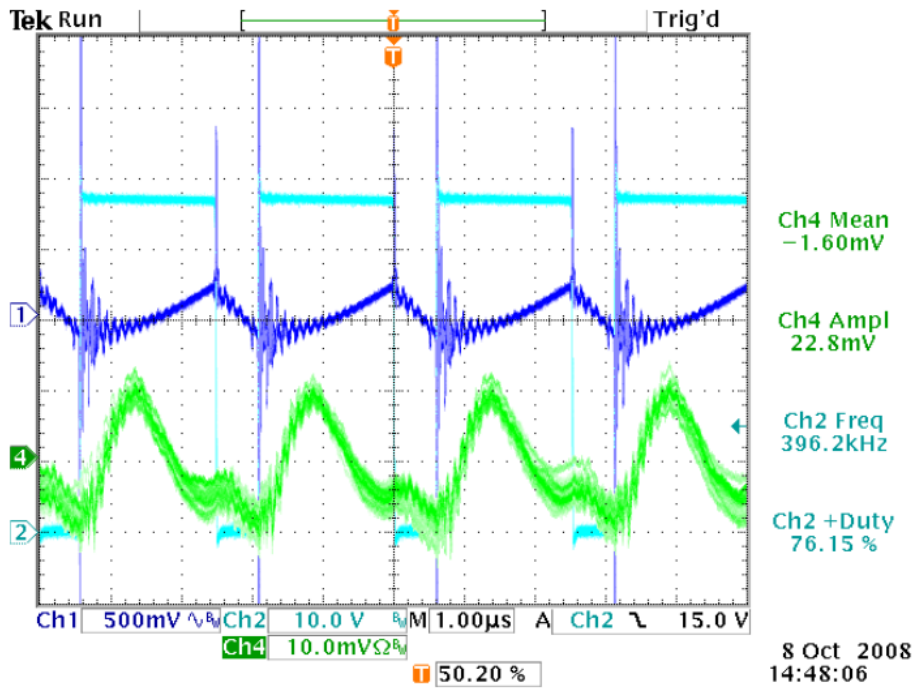

Figure 8 – Output current ripple 10 LEDs, $V_{IN} = 48 V$

CH3 – Dimming input signal (high level – output disable)

CH4 – Output current 200mA/div

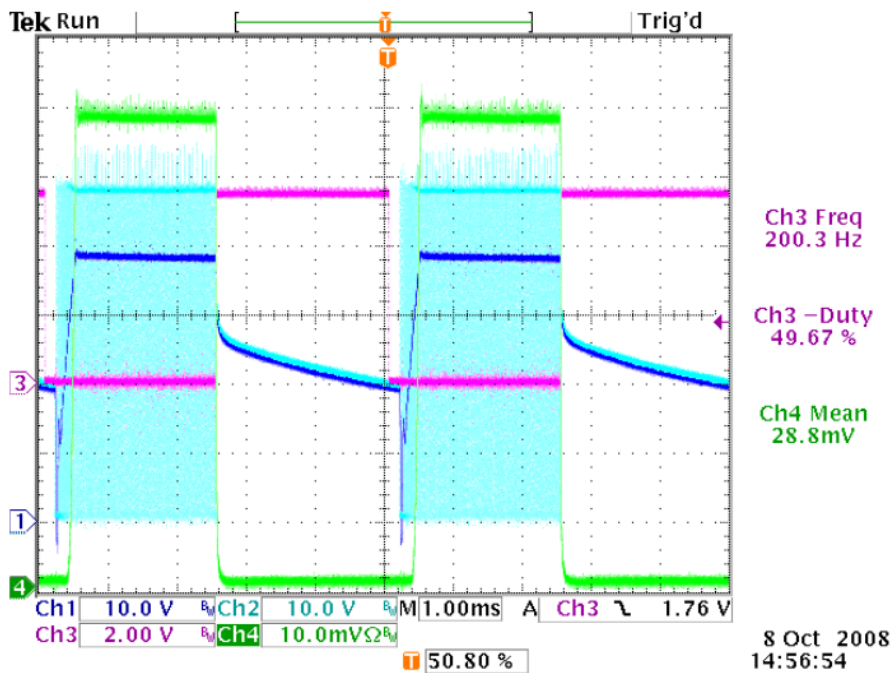

Figure 9 – Dimming 200 Hz, 10 LEDs, $V_{IN} = 48 V$

DN06047/D

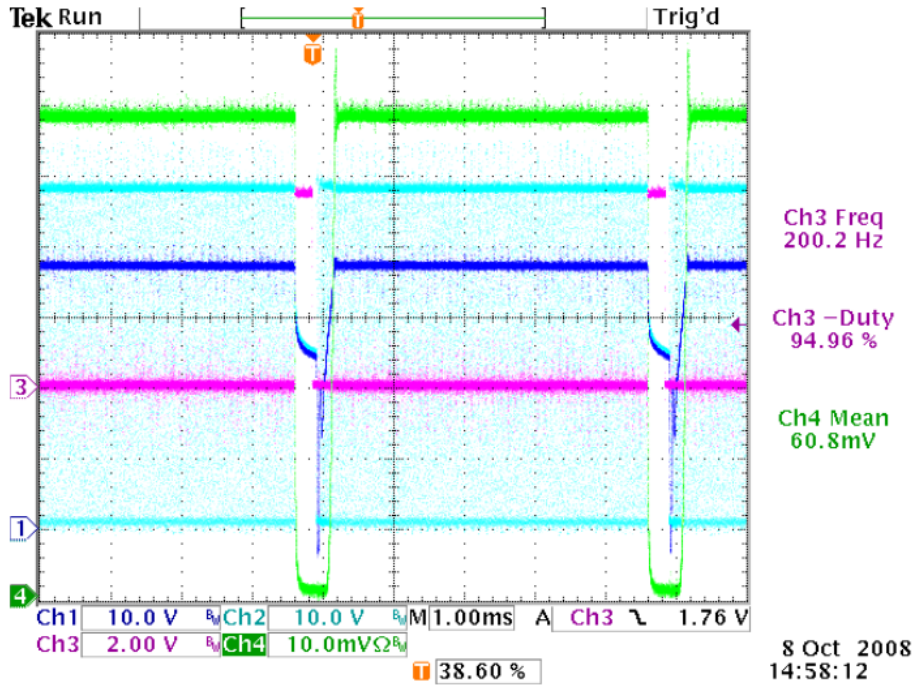

Figure 10 – Dimming 200Hz high duty cycle, 10 LEDs, $V_{IN} = 48 V$

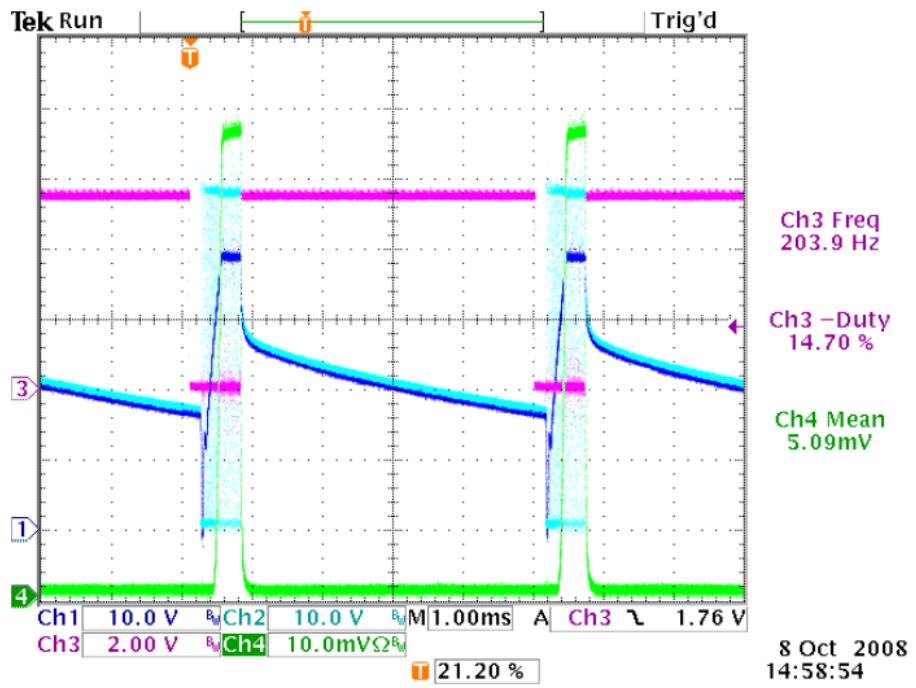

Figure 11 – Dimming 200Hz low duty cycle, 10 LEDs, $V_{IN} = 48 V$

DN06047/D

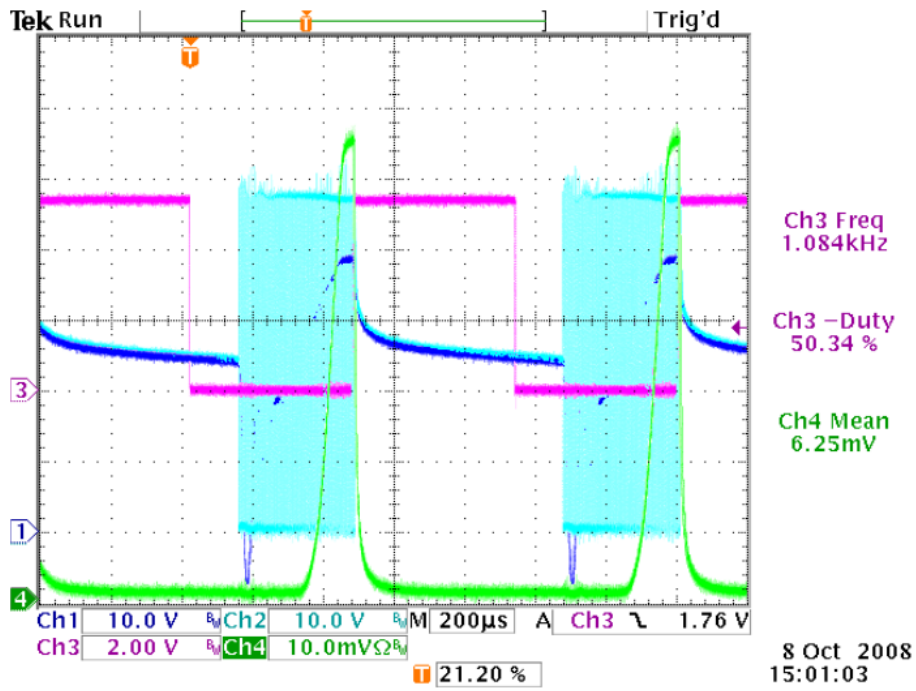

Figure 12 – Dimming 1000 Hz, 10 LEDs, $V_{IN} = 48 V$

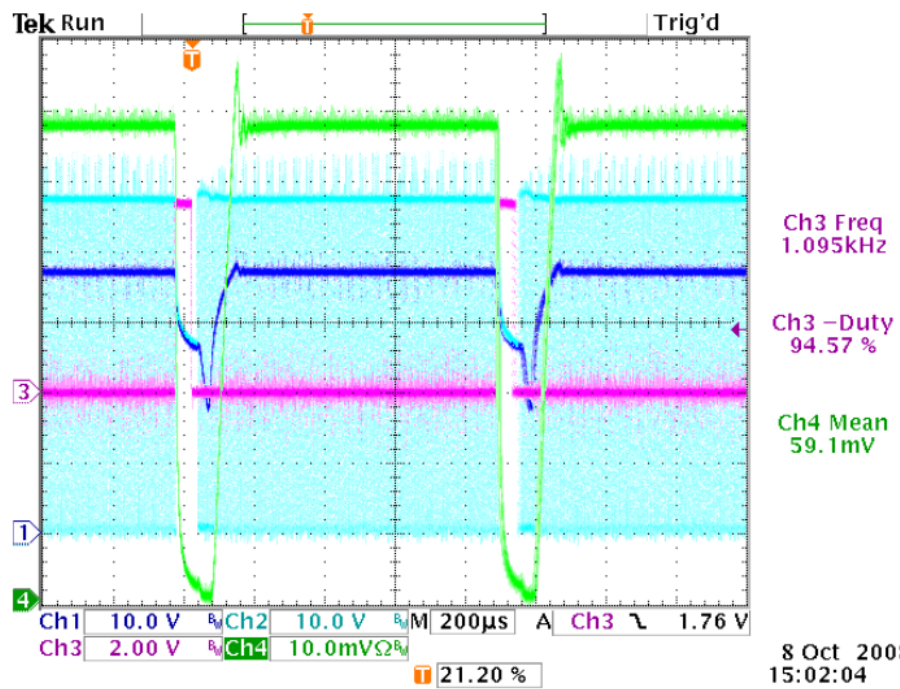

Figure 13 – Dimming 1000Hz high duty cycle, 10 LEDs, $V_{IN} = 48 V$

DN06047/D

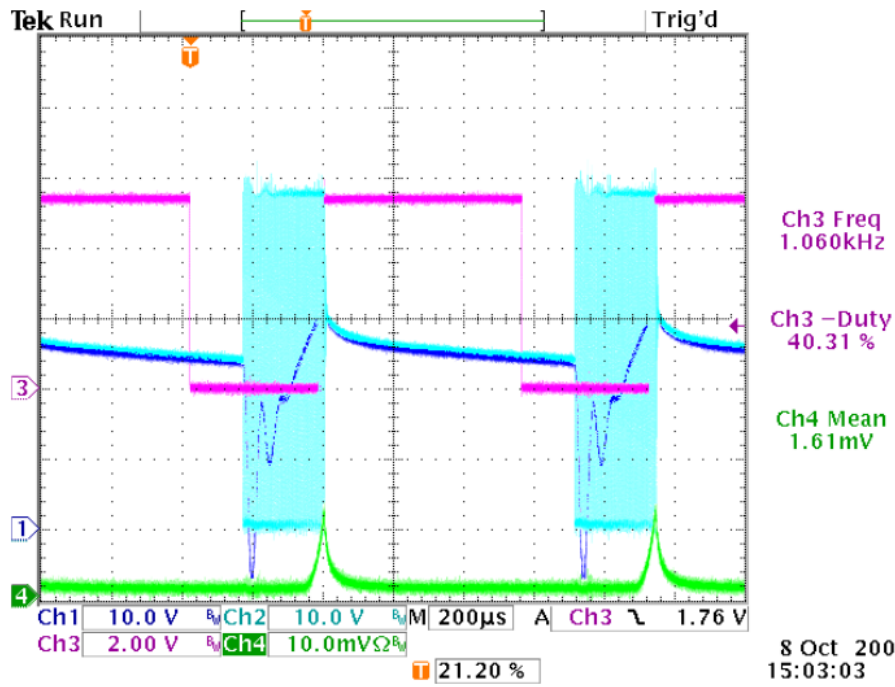

Figure 14 – Dimming 1000Hz low duty cycle, 10 LEDs, $V_{IN} = 48 V$

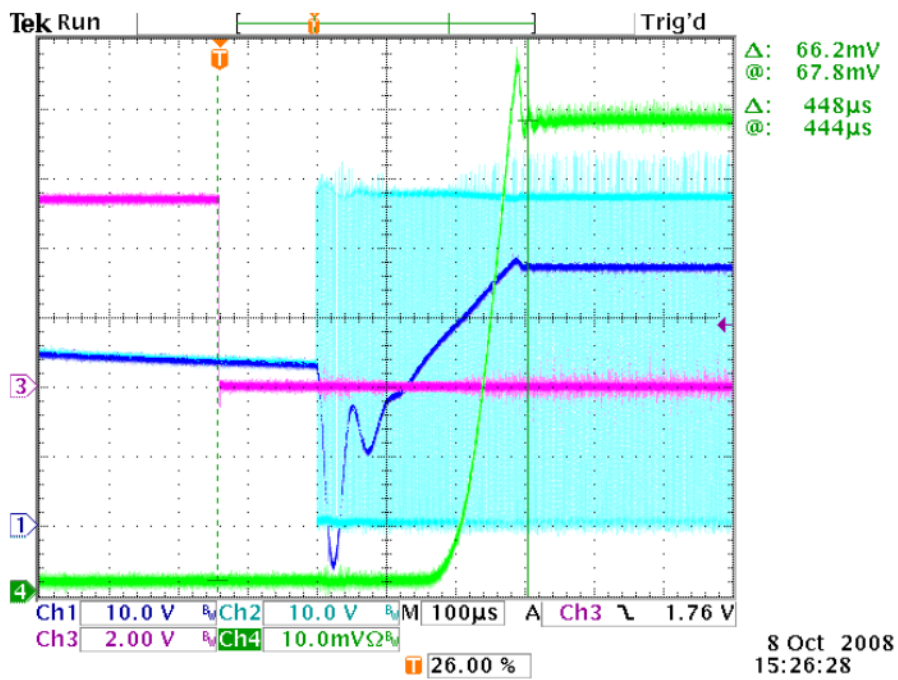

Figure 15 – Switch-on delay 10 LEDs, $V_{IN} = 48 V$

DN06047/D

Table 1 – Bill of materials

Designator	Qty.	Description	Value	Tol.	Footprint	Manufacturer	Manufacturer Part Number	Subst. Allowed	Lead Free	Comments
R14	1	Resistor	0R	1%	1206	Vishay	CRCW1206000Z0EA	Yes	Yes	
R11	1	Resistor	3k3	1%	1206	Vishay	CRCW12063K30FKEA	Yes	Yes	
R6, R10	2	Resistor	3k9	1%	1206	Vishay	CRCW12063K90FKEA	Yes	Yes	
R5, R15	2	Resistor	4k7	1%	1206	Vishay	CRCW12064K70FKEA	Yes	Yes	
R8	1	Resistor	9k1	1%	1206	Vishay	CRCW12069K10FKEA	Yes	Yes	
R2, R4, R9, R17	4	Resistor	10k	1%	1206	Vishay	CRCW120610K0FKEA	Yes	Yes	
R1, R7	2	Resistor	22k	1%	1206	Vishay	CRCW120622K0FKEA	Yes	Yes	
R3	1	Resistor	56k	1%	1206	Vishay	CRCW120656K0FKEA	Yes	Yes	
R16	1	Resistor	68k	1%	1206	Vishay	CRCW120668K0FKEA	Yes	Yes	
R12A	1	Resistor	R24	1%	1206	Rohm	MCR18EZHFLR240	Yes	Yes	
R12B	1	Resistor	R27	1%	1206	Rohm	MCR18EZHFLR270	Yes	Yes	
C10	1	Ceramic Capacitor	1n	10%	1206	Kemet	C1206C102K5RACTU	Yes	Yes	
C9	1	Ceramic Capacitor	2n2	10%	1206	Kemet	C1206C222K5RACTU	Yes	Yes	
C8	1	Ceramic Capacitor	10n	10%	1206	Kemet	C1206C103K5RACTU	Yes	Yes	
C7	1	Ceramic Capacitor	820p	10%	1206	Kemet	C1206C821K5RACTU	Yes	Yes	
C2, C3, C4, C5, C6	5	Ceramic Capacitor	100n	10%	1206	Kemet	C1206F104K1RACTU	Yes	Yes	
C11	1	Ceramic Capacitor	1u/50V	10%	1206	TDK	C3216X7R1H105K	Yes	Yes	
C1	1	Ceramic Capacitor	4u7/100V	10%	1812	United Chemi-Con	KTS101B475K43N0T00	Yes	Yes	
L1	1	Inductor SMD	56u	10%	13x13	Coilcraft	MSS1260-563	Yes	Yes	
D1	1	Switching Diode	MMSD4148	-	SOD123	ON Semiconductor	MMSD4148T1G	Yes	Yes	
D2	1	Zener Diode 12V	MMSZ4699	-	SOD123	ON Semiconductor	MMSZ4699T1G	Yes	Yes	
Q1	1	NPN Transistor	MJD31	-	DPAK	ON Semiconductor	MJD31T4G	Yes	Yes	
Q2, Q3	1	Power N-MOSFET	NTD3055	-	DPAK	ON Semiconductor	NTD3055-150G	Yes	Yes	
Q4	1	Small NPN Transistor	BC817	-	SOT-23	ON Semiconductor	BC81740LT1G	Yes	Yes	
IC2	1	Dual OPAMP	LM358	-	SOIC8	ON Semiconductor	LM358DR2G	No	Yes	
IC1	1	Synchronous PWM buck controller	NCP1034	-	SOIC16	ON Semiconductor	NCP1034DR2G	No	Yes	

© 2008 ON Semiconductor.

Disclaimer: ON Semiconductor is providing this design note "AS IS" and does not assume any liability arising from its use; nor does ON Semiconductor convey any license to its or any third party's intellectual property rights. This document is provided only to assist customers in evaluation of the referenced circuit implementation and the recipient assumes all liability and risk associated with its use, including, but not limited to, compliance with all regulatory standards. ON Semiconductor may change any of its products at any time, without notice.

Design note created by Tomáš Tichý, e-mail: Tomas.Tichy@onsemi.com