

Bridge Rectifiers

GBU8A - GBU8M

Features

- Glass–Passivated Junction
- Surge Overload Rating: 200 A Peak
- Reliable Low–Cost Construction Utilizing Molded Plastic Technique
- Ideal for Printed Circuit Board
- UL Certified: UL #E258596

PACKAGE MARKING AND ORDERING INFORMATION

Part Number	Marking	Package	Packing Method
GBU8A	GBU8A	GBU 4L	Rail
GBU8B	GBU8B		
GBU8D	GBU8D		
GBU8G	GBU8G		
GBU8J	GBU8J		
GBU8K	GBU8K		
GBU8M	GBU8M		



SIP4
CASE 127EL

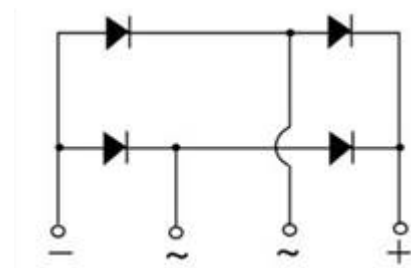

MARKING DIAGRAM

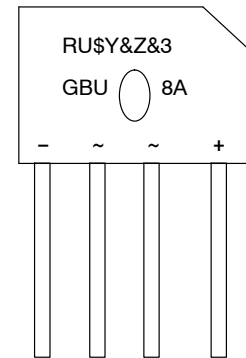

- | | |
|-------|-------------------------|
| RU | = UL Marking |
| \$Y | = ON Semiconductor Logo |
| &Z | = Assembly Plant Code |
| &3 | = Numeric Date Code |
| GBU8A | = Specific Device Code |

GBU8A – GBU8M

ABSOLUTE MAXIMUM RATINGS ($T_A = 25^\circ\text{C}$ unless otherwise noted)

Symbol	Parameter	Value							Units	
		8A	8B	8D	8G	8J	8K	8M		
V_{RRM}	Maximum Repetitive Reverse Voltage	50	100	200	400	600	800	1000	V	
V_{RMS}	Maximum RMS Bridge Input Voltage	35	70	140	280	420	560	700	V	
V_R	DC Reverse Voltage (Rated V_R)	50	100	200	400	600	800	1000	V	
$I_{F(AV)}$	Average Rectified Forward Current	$T_A = 100^\circ\text{C}$							8.0	A
		$T_A = 45^\circ\text{C}$							6.0	A
I_{FSM}	Non-Repetitive Peak Forward Surge Current 8.3 ms Single Half-Sine-Wave	200							A	
T_{STG}	Storage Temperature Range	-55 to +150							$^\circ\text{C}$	
T_J	Operating Junction Temperature	-55 to +150							$^\circ\text{C}$	

Stresses exceeding those listed in the Maximum Ratings table may damage the device. If any of these limits are exceeded, device functionality should not be assumed, damage may occur and reliability may be affected.

THERMAL CHARACTERISTICS ($T_A = 25^\circ\text{C}$ unless otherwise noted)

Symbol	Parameter	Value	Units
P_D	Power Dissipation	16	W
$R_{\theta JA}$	Thermal Resistance per Leg, Junction to Ambient (Note 1)	18	$^\circ\text{C}/\text{W}$
$R_{\theta JL}$	Thermal Resistance per Leg, Junction to Case (Note 2)	3	$^\circ\text{C}/\text{W}$

1. Device mounted on PCB with 0.5×0.5 inch (12×12 mm)
2. Heat sink mounting, $4 \times 4 \times 0.15$ inch copper plate

ELECTRICAL CHARACTERISTICS ($T_J = 25^\circ\text{C}$ unless otherwise noted)

Symbol	Parameter	Value	Units
V_F	Forward Voltage, per Element	8.0 A	1.0 V
I_R	Reverse Current, per Element at Rated V_R	$T_A = 25^\circ\text{C}$	5.0 μA
		$T_A = 100^\circ\text{C}$	500 μA
I^2t	I^2t Rating for Fusing	$t < 8.35$ ms	166 A^2s

Product parametric performance is indicated in the Electrical Characteristics for the listed test conditions, unless otherwise noted. Product performance may not be indicated by the Electrical Characteristics if operated under different conditions.

GBU8A – GBU8M

TYPICAL PERFORMANCE CHARACTERISTICS

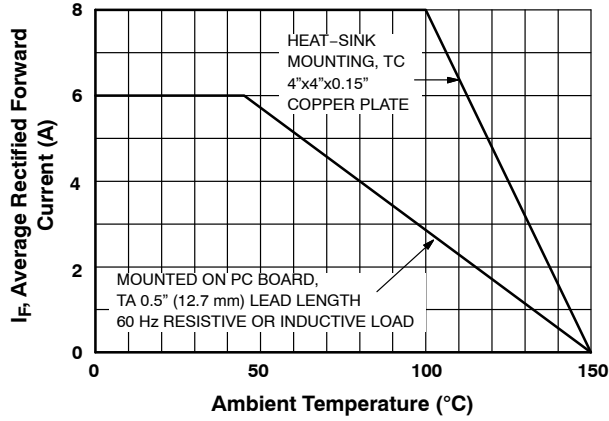

Figure 1. Forward Current Derating Curve

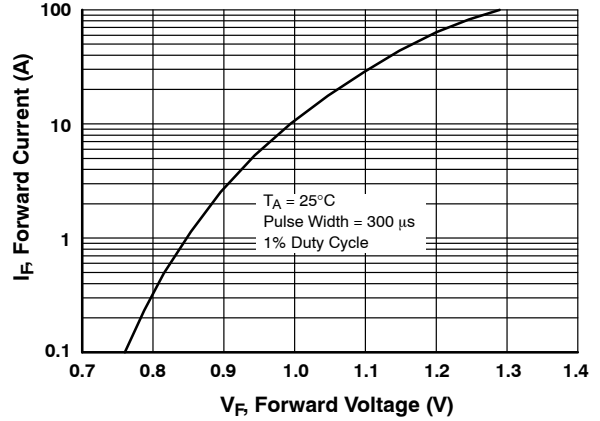

Figure 2. Forward Voltage Characteristics

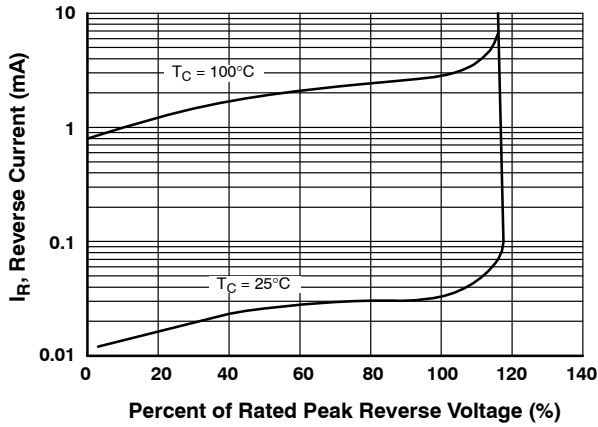

Figure 3. Reverse Current vs. Reverse Voltage

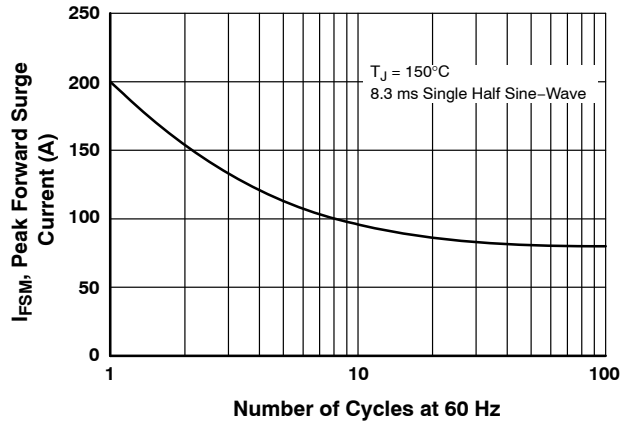

Figure 4. Non-Repetitive Surge Current

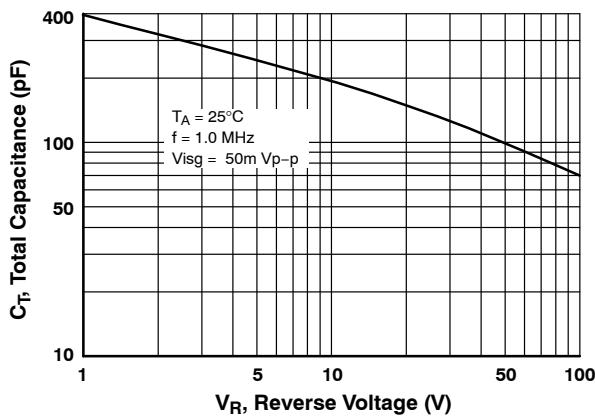
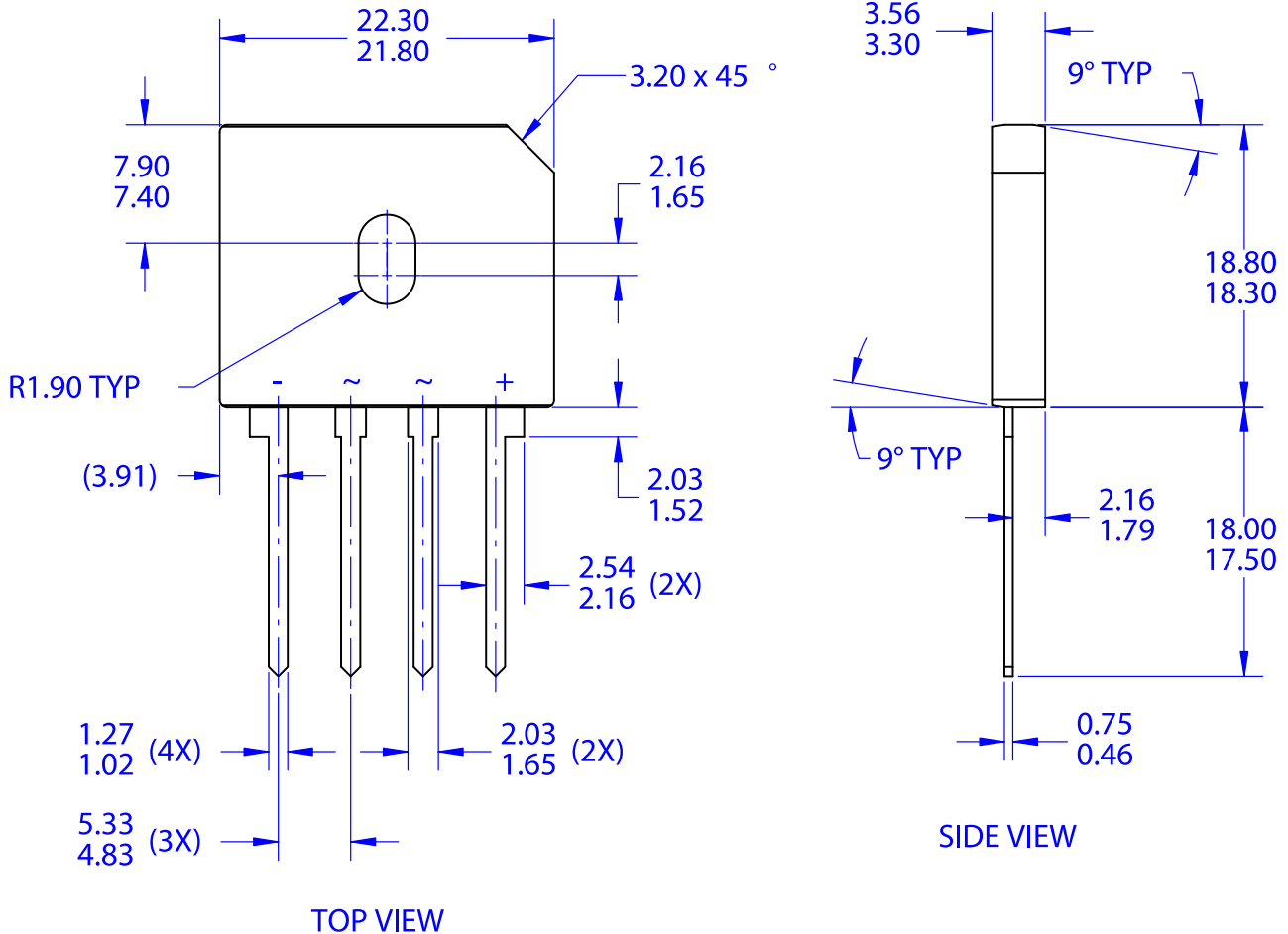

Figure 5. Total Capacitance

SIP4 22.05x18.55
CASE 127EL
ISSUE 0

DATE 31 DEC 2016



- NOTES:
- A. NO INDUSTRY STANDARD APPLIES TO THIS PACKAGE
 - B. ALL DIMENSIONS ARE IN MILLIMETERS
 - C. DIMENSIONS ARE EXCLUSIVE OF BURRS, MOLD FLASH AND TIE BAR PROTRUSIONS.
 - D. DIMENSIONS AND TOLERANCES AS PER ASME Y14.5-2009

DOCUMENT NUMBER:	98AON13717G	Electronic versions are uncontrolled except when accessed directly from the Document Repository. Printed versions are uncontrolled except when stamped "CONTROLLED COPY" in red.
DESCRIPTION:	SIP4 22.05x18.55	PAGE 1 OF 1

onsemi and ONSEMI are trademarks of Semiconductor Components Industries, LLC dba onsemi or its subsidiaries in the United States and/or other countries. onsemi reserves the right to make changes without further notice to any products herein. onsemi makes no warranty, representation or guarantee regarding the suitability of its products for any particular purpose, nor does onsemi assume any liability arising out of the application or use of any product or circuit, and specifically disclaims any and all liability, including without limitation special, consequential or incidental damages. onsemi does not convey any license under its patent rights nor the rights of others.

onsemi, **Onsemi**, and other names, marks, and brands are registered and/or common law trademarks of Semiconductor Components Industries, LLC dba "**onsemi**" or its affiliates and/or subsidiaries in the United States and/or other countries. **onsemi** owns the rights to a number of patents, trademarks, copyrights, trade secrets, and other intellectual property. A listing of **onsemi**'s product/patent coverage may be accessed at www.onsemi.com/site/pdf/Patent-Marking.pdf. **onsemi** reserves the right to make changes at any time to any products or information herein, without notice. The information herein is provided "as-is" and **onsemi** makes no warranty, representation or guarantee regarding the accuracy of the information, product features, availability, functionality, or suitability of its products for any particular purpose, nor does **onsemi** assume any liability arising out of the application or use of any product or circuit, and specifically disclaims any and all liability, including without limitation special, consequential or incidental damages. Buyer is responsible for its products and applications using **onsemi** products, including compliance with all laws, regulations and safety requirements or standards, regardless of any support or applications information provided by **onsemi**. "Typical" parameters which may be provided in **onsemi** data sheets and/or specifications can and do vary in different applications and actual performance may vary over time. All operating parameters, including "Typicals" must be validated for each customer application by customer's technical experts. **onsemi** does not convey any license under any of its intellectual property rights nor the rights of others. **onsemi** products are not designed, intended, or authorized for use as a critical component in life support systems or any FDA Class 3 medical devices or medical devices with a same or similar classification in a foreign jurisdiction or any devices intended for implantation in the human body. Should Buyer purchase or use **onsemi** products for any such unintended or unauthorized application, Buyer shall indemnify and hold **onsemi** and its officers, employees, subsidiaries, affiliates, and distributors harmless against all claims, costs, damages, and expenses, and reasonable attorney fees arising out of, directly or indirectly, any claim of personal injury or death associated with such unintended or unauthorized use, even if such claim alleges that **onsemi** was negligent regarding the design or manufacture of the part. **onsemi** is an Equal Opportunity/Affirmative Action Employer. This literature is subject to all applicable copyright laws and is not for resale in any manner.

ADDITIONAL INFORMATION

TECHNICAL PUBLICATIONS:

Technical Library: www.onsemi.com/design/resources/technical-documentation
onsemi Website: www.onsemi.com

ONLINE SUPPORT: www.onsemi.com/support

For additional information, please contact your local Sales Representative at www.onsemi.com/support/sales