

# Integrated Load Switch

## FDC6329L

### Description

This device is particularly suited for compact power management in portable electronic equipment where 2.5 V to 8 V input and 2.5 A output current capability are needed. This load switch integrates a small N-Channel power MOSFET (Q1) which drives a large P-Channel power MOSFET (Q2) in one tiny SUPERSOT™-6 package.

### Features

- $V_{DROPP} = 0.20\text{ V @ } V_{IN} = 5\text{ V, } I_L = 2.8\text{ A, } R_{(on)} = 0.07\ \Omega$
- $V_{DROPP} = 0.20\text{ V @ } V_{IN} = 2.5\text{ V, } I_L = 1.9\text{ A, } R_{(on)} = 0.105\ \Omega$
- Control MOSFET (Q1) Includes Zener Protection for ESD Ruggedness (> 6 kV Human Body Model)
- High Performance Trench Technology for Extremely Low On-Resistance
- SUPERSOT-6 Package Design Using Copper Lead Frame for Superior Thermal and Electrical Capabilities
- This is a Pb-Free and Halide Free Device

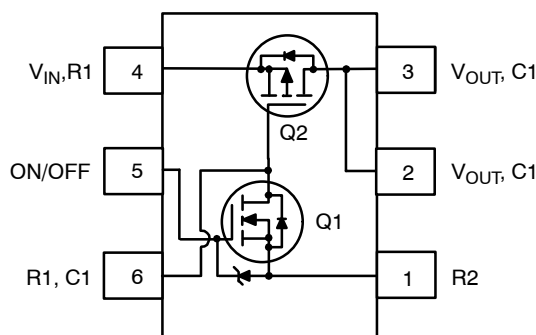

See Application Circuit (Figure 3)

Figure 1.

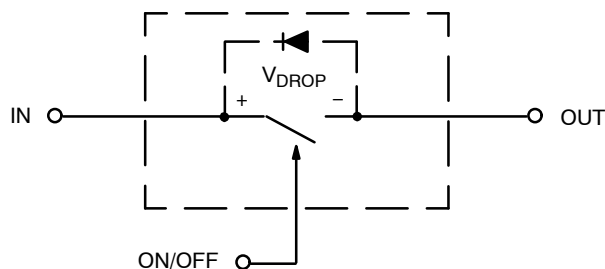

Figure 2. Equivalent Circuit



ON Semiconductor®

[www.onsemi.com](http://www.onsemi.com)



TSOT-23-6  
CASE 419BL

### MARKING DIAGRAM

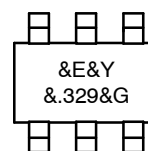

- &E = Designates Space
- &Y = Binary Calendar Year Coding Scheme
- &. = Pin One Dot
- 329 = Specific Device Code
- &G = Date Code

### ORDERING INFORMATION

Device	Package	Shipping†
FDC6329L	TSOT-23-6 (Pb-Free)	3000 / Tape & Reel

†For information on tape and reel specifications, including part orientation and tape sizes, please refer to our Tape and Reel Packaging Specification Brochure, BRD8011/D.

# FDC6329L

## ABSOLUTE MAXIMUM RATINGS $T_A = 25^\circ\text{C}$ unless otherwise noted

Symbol	Parameter	Value	Unit
$V_{IN}$	Input Voltage Range (Note 1)	2.5–8	V
$V_{ON/OFF}$	On/Off Voltage Range	1.5–8	V
$I_L$	Load Current – Continuous (Note 2)	2.5	A
	Load Current – Pulsed	10	
$P_D$	Maximum Power Dissipation (Note 2)	0.7	W
$T_J, T_{STG}$	Operating and Storage Temperature Range	–55 to 150	$^\circ\text{C}$
ESD	Electrostatic Discharge Rating MIL–STD–883D Human Body Model (100 pF / 1500 $\Omega$ )	6	kV

Stresses exceeding those listed in the Maximum Ratings table may damage the device. If any of these limits are exceeded, device functionality should not be assumed, damage may occur and reliability may be affected.

## THERMAL CHARACTERISTICS $T_A = 25^\circ\text{C}$ unless otherwise noted

Symbol	Parameter	Value	Unit
$R_{\theta JA}$	Thermal Resistance, Junction–to–Ambient (Note 2)	180	$^\circ\text{C}/\text{W}$
$R_{\theta JC}$	Thermal Resistance, Junction–to–Case (Note 2)	60	$^\circ\text{C}/\text{W}$

## ELECTRICAL CHARACTERISTICS $T_A = 25^\circ\text{C}$ unless otherwise noted

Symbol	Parameter	Test Conditions	Min	Typ	Max	Unit
--------	-----------	-----------------	-----	-----	-----	------

### OFF CHARACTERISTICS

$I_{FL}$	Forward Leakage Current	$V_{IN} = 8\text{ V}, V_{ON/OFF} = 0\text{ V}$	–	–	1	$\mu\text{A}$
----------	-------------------------	--	---	---	---	---------------

### ON CHARACTERISTICS (Note 3)

$V_{DROP}$	Conduction Voltage	$V_{IN} = 5\text{ V}, V_{ON/OFF} = 3.3\text{ V}, I_L = 2.8\text{ A}$	–	0.12	0.2	V
		$V_{IN} = 2.5\text{ V}, V_{ON/OFF} = 3.3\text{ V}, I_L = 1.9\text{ A}$	–	0.14	0.2	
$R_{DS(on)}$	Q <sub>2</sub> – Static On–Resistance	$V_{GS} = -5\text{ V}, I_D = -2.5\text{ A}$	–	0.047	0.07	$\Omega$
		$V_{GS} = -2.5\text{ V}, I_D = -2.0\text{ A}$	–	0.073	0.105	
$I_L$	Load Current	$V_{DROP} = 0.2\text{ V}, V_{IN} = 5\text{ V}, V_{ON/OFF} = 3.3\text{ V}$	2.8	–	–	A
		$V_{DROP} = 0.2\text{ V}, V_{IN} = 2.5\text{ V}, V_{ON/OFF} = 3.3\text{ V}$	1.9	–	–	

Product parametric performance is indicated in the Electrical Characteristics for the listed test conditions, unless otherwise noted. Product performance may not be indicated by the Electrical Characteristics if operated under different conditions.

### NOTES:

- Range of  $V_{IN}$  can be up to 8 V, but  $R_1$  and  $R_2$  must be scaled such that  $V_{GS}$  of Q<sub>2</sub> does not exceed –8 V.
- $R_{\theta JA}$  is the sum of the junction–to–case and case–to–ambient thermal resistance where the case thermal reference is defined as the solder mounting surface of the drain pins.  $R_{\theta JC}$  is guaranteed by design while  $R_{\theta CA}$  is determined by the user’s board design.
- Pulse Test: Pulse Width  $\leq 300\ \mu\text{s}$ , Duty Cycle  $\leq 2.0\%$ .

# FDC6329L

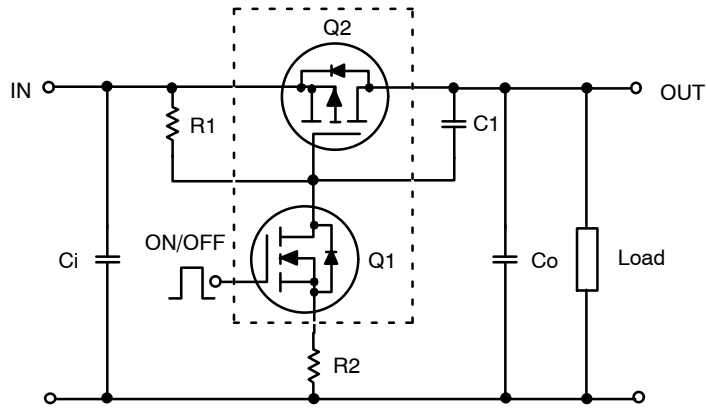

Figure 3. FDC6329L Load Switch Application

## External Component Recommendation:

For applications where  $C_o \leq 1 \mu\text{F}$ .

For slew rate control, select R2 in the range of 1k – 4.7 k $\Omega$ .

For additional in-rush current control,  $C_1 \leq 1000 \text{ pF}$  can be added.

Select R1 so that the R1/R2 ratio ranges from 10 – 100. R1 is required to turn Q2 off.

## TYPICAL CHARACTERISTICS

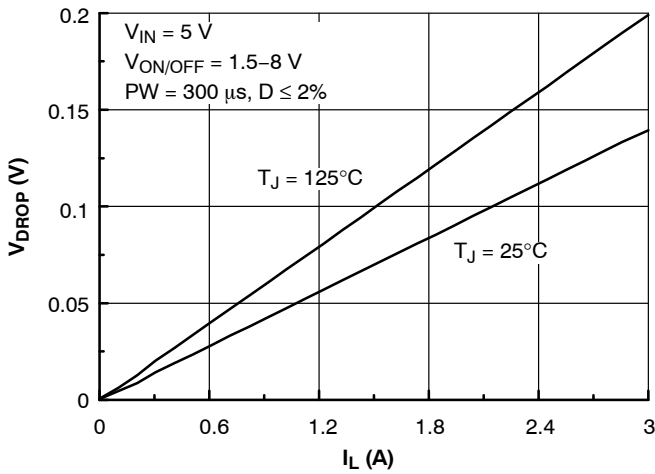

Figure 4. Conduction Voltage Drop Variation with Load Current

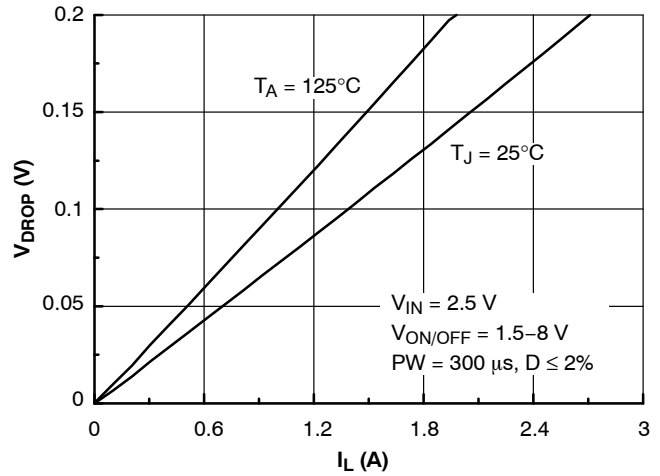

Figure 5. Conduction Voltage Drop Variation with Load Current

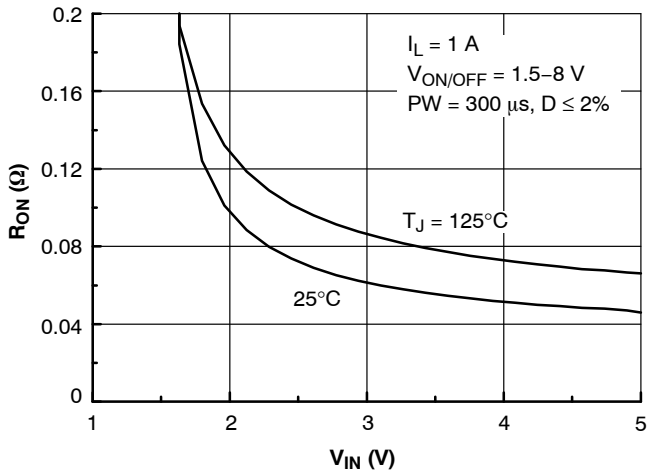

Figure 6. On-Resistance Variation with Input Voltage

TYPICAL CHARACTERISTICS (continued)

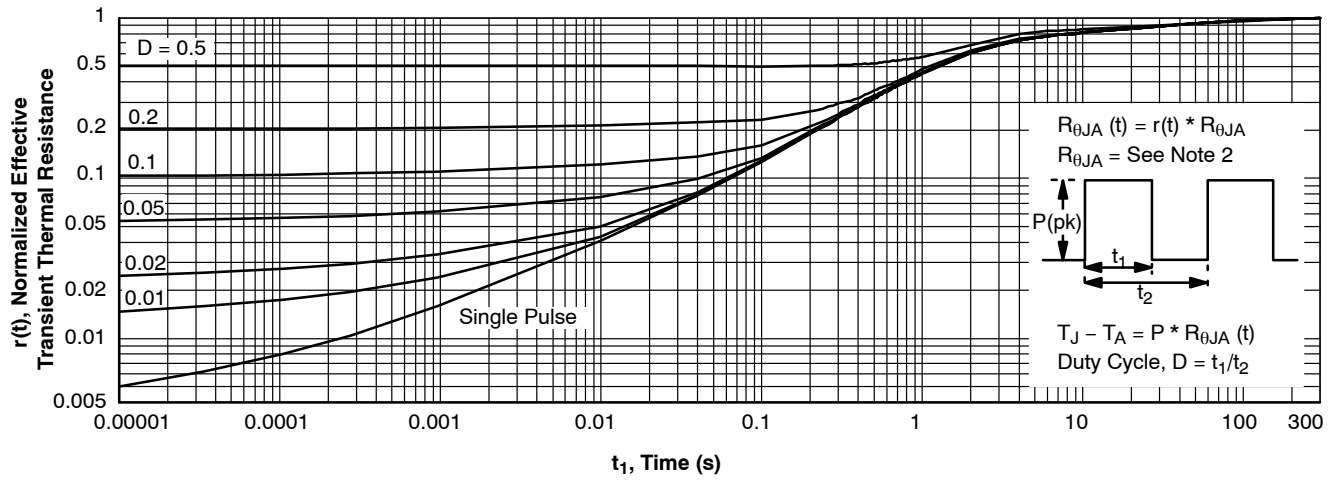

Figure 7. Transient Thermal Response Curve

NOTE: Thermal characterization performed on the conditions described in Note 2.  
 Transient thermal response will change depending on the circuit board design.



1  
SCALE 2:1

TSOT23 6-Lead  
CASE 419BL  
ISSUE A

DATE 31 AUG 2020

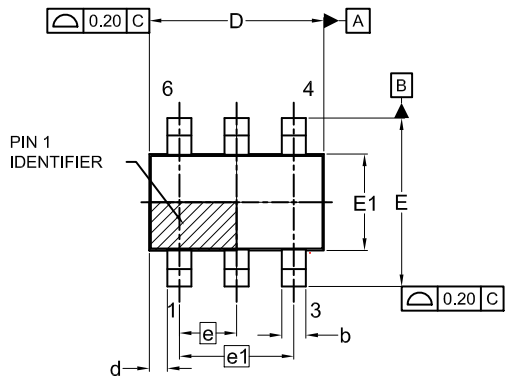

TOP VIEW

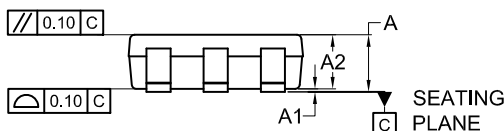

FRONT VIEW

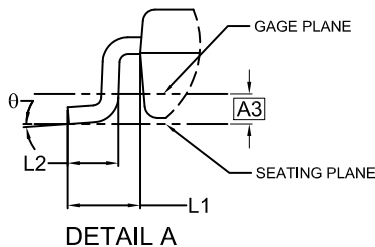

DETAIL A

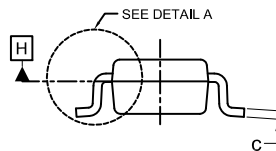

SIDE VIEW

SYMM  
⌀

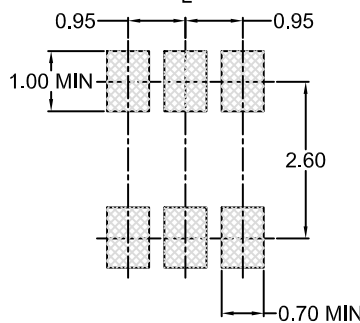

LAND PATTERN  
RECOMMENDATION

\*FOR ADDITIONAL INFORMATION ON OUR  
Pb-FREE STRATEGY AND SOLDERING DETAILS,  
PLEASE DOWNLOAD THE ON SEMICONDUCTOR  
SOLDERING AND MOUNTING TECHNIQUES  
REFERENCE MANUAL, SOLDERRM/D.

NOTES:

1. DIMENSIONING AND TOLERANCING PER ASME Y14.5M, 2009.
2. CONTROLLING DIMENSION: MILLIMETERS
3. DIMENSIONS D AND E1 DO NOT INCLUDE MOLD FLASH, PROTRUSIONS, OR GATE BURRS. MOLD FLASH, PROTRUSIONS OR GATE BURRS SHALL NOT EXCEED 0.25MM PER END. DIMENSIONS D AND E1 ARE DETERMINED AT DATUM H.
4. SEATING PLANE IS DEFINED BY THE TERMINALS. "A1" IS DEFINED AS THE DISTANCE FROM THE SEATING PLANE TO THE LOWEST POINT ON THE PACKAGE BODY.

DIM	MILLIMETERS		
	MIN.	NOM.	MAX.
A	0.90	1.00	1.10
A1	0.00	0.05	0.10
A2	0.70	0.85	1.00
A3	0.25 BSC		
b	0.25	0.38	0.50
c	0.10	0.18	0.26
D	2.80	2.95	3.10
d	0.30 REF		
E	2.50	2.75	3.00
E1	1.30	1.50	1.70
e	0.95 BSC		
e1	1.90 BSC		
L1	0.60 REF		
L2	0.20	0.40	0.60
⊖	0°	--	10°

GENERIC  
MARKING DIAGRAM\*

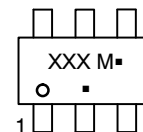

XXX = Specific Device Code  
M = Date Code  
▪ = Pb-Free Package

(Note: Microdot may be in either location)

\*This information is generic. Please refer to device data sheet for actual part marking. Pb-Free indicator, "G" or microdot "▪", may or may not be present. Some products may not follow the Generic Marking.

DOCUMENT NUMBER:	98AON83292G	Electronic versions are uncontrolled except when accessed directly from the Document Repository. Printed versions are uncontrolled except when stamped "CONTROLLED COPY" in red.
DESCRIPTION:	TSOT23 6-Lead	PAGE 1 OF 1

onsemi and Onsemi are trademarks of Semiconductor Components Industries, LLC dba onsemi or its subsidiaries in the United States and/or other countries. onsemi reserves the right to make changes without further notice to any products herein. onsemi makes no warranty, representation or guarantee regarding the suitability of its products for any particular purpose, nor does onsemi assume any liability arising out of the application or use of any product or circuit, and specifically disclaims any and all liability, including without limitation special, consequential or incidental damages. onsemi does not convey any license under its patent rights nor the rights of others.

**onsemi**, **Onsemi**, and other names, marks, and brands are registered and/or common law trademarks of Semiconductor Components Industries, LLC dba "**onsemi**" or its affiliates and/or subsidiaries in the United States and/or other countries. **onsemi** owns the rights to a number of patents, trademarks, copyrights, trade secrets, and other intellectual property. A listing of **onsemi**'s product/patent coverage may be accessed at [www.onsemi.com/site/pdf/Patent-Marking.pdf](http://www.onsemi.com/site/pdf/Patent-Marking.pdf). **onsemi** reserves the right to make changes at any time to any products or information herein, without notice. The information herein is provided "as-is" and **onsemi** makes no warranty, representation or guarantee regarding the accuracy of the information, product features, availability, functionality, or suitability of its products for any particular purpose, nor does **onsemi** assume any liability arising out of the application or use of any product or circuit, and specifically disclaims any and all liability, including without limitation special, consequential or incidental damages. Buyer is responsible for its products and applications using **onsemi** products, including compliance with all laws, regulations and safety requirements or standards, regardless of any support or applications information provided by **onsemi**. "Typical" parameters which may be provided in **onsemi** data sheets and/or specifications can and do vary in different applications and actual performance may vary over time. All operating parameters, including "Typicals" must be validated for each customer application by customer's technical experts. **onsemi** does not convey any license under any of its intellectual property rights nor the rights of others. **onsemi** products are not designed, intended, or authorized for use as a critical component in life support systems or any FDA Class 3 medical devices or medical devices with a same or similar classification in a foreign jurisdiction or any devices intended for implantation in the human body. Should Buyer purchase or use **onsemi** products for any such unintended or unauthorized application, Buyer shall indemnify and hold **onsemi** and its officers, employees, subsidiaries, affiliates, and distributors harmless against all claims, costs, damages, and expenses, and reasonable attorney fees arising out of, directly or indirectly, any claim of personal injury or death associated with such unintended or unauthorized use, even if such claim alleges that **onsemi** was negligent regarding the design or manufacture of the part. **onsemi** is an Equal Opportunity/Affirmative Action Employer. This literature is subject to all applicable copyright laws and is not for resale in any manner.

---

## ADDITIONAL INFORMATION

### TECHNICAL PUBLICATIONS:

Technical Library: [www.onsemi.com/design/resources/technical-documentation](http://www.onsemi.com/design/resources/technical-documentation)  
onsemi Website: [www.onsemi.com](http://www.onsemi.com)

### ONLINE SUPPORT: [www.onsemi.com/support](http://www.onsemi.com/support)

For additional information, please contact your local Sales Representative at [www.onsemi.com/support/sales](http://www.onsemi.com/support/sales)