

NTD4302

MOSFET – Power, N-Channel, DPAK/IPAK 68 A, 30 V



ON Semiconductor®

<http://onsemi.com>

Features

- Ultra Low $R_{DS(on)}$
- Higher Efficiency Extending Battery Life
- Logic Level Gate Drive
- Diode Exhibits High Speed, Soft Recovery
- Avalanche Energy Specified
- I_{DSS} Specified at Elevated Temperature
- DPAK Mounting Information Provided
- These Devices are Pb-Free and are RoHS Compliant

Applications

- DC-DC Converters
- Low Voltage Motor Control
- Power Management in Portable and Battery Powered Products: i.e., Computers, Printers, Cellular and Cordless Telephones, and PCMCIA Cards

MAXIMUM RATINGS ($T_C = 25^\circ\text{C}$ unless otherwise noted)

| Rating | Symbol | Value | Unit |
|--|-----------------|------------|---------------------------|
| Drain-to-Source Voltage | V_{DSS} | 30 | Vdc |
| Gate-to-Source Voltage – Continuous | V_{GS} | ± 20 | Vdc |
| Thermal Resistance – Junction-to-Case | $R_{\theta JC}$ | 1.65 | $^\circ\text{C}/\text{W}$ |
| Total Power Dissipation @ $T_C = 25^\circ\text{C}$ | P_D | 75 | W |
| Continuous Drain Current @ $T_C = 25^\circ\text{C}$ (Note 4) | I_D | 68 | A |
| Continuous Drain Current @ $T_C = 100^\circ\text{C}$ | I_D | 43 | A |
| Thermal Resistance – Junction-to-Ambient (Note 2) | $R_{\theta JA}$ | 67 | $^\circ\text{C}/\text{W}$ |
| Total Power Dissipation @ $T_A = 25^\circ\text{C}$ | P_D | 1.87 | W |
| Continuous Drain Current @ $T_A = 25^\circ\text{C}$ | I_D | 11.3 | A |
| Continuous Drain Current @ $T_A = 100^\circ\text{C}$ | I_D | 7.1 | A |
| Pulsed Drain Current (Note 3) | I_{DM} | 36 | A |
| Thermal Resistance – Junction-to-Ambient (Note 1) | $R_{\theta JA}$ | 120 | $^\circ\text{C}/\text{W}$ |
| Total Power Dissipation @ $T_A = 25^\circ\text{C}$ | P_D | 1.04 | W |
| Continuous Drain Current @ $T_A = 25^\circ\text{C}$ | I_D | 8.4 | A |
| Continuous Drain Current @ $T_A = 100^\circ\text{C}$ | I_D | 5.3 | A |
| Pulsed Drain Current (Note 3) | I_{DM} | 28 | A |
| Operating and Storage Temperature Range | T_J, T_{stg} | -55 to 150 | $^\circ\text{C}$ |
| Single Pulse Drain-to-Source Avalanche Energy – Starting $T_J = 25^\circ\text{C}$ ($V_{DD} = 30 \text{ Vdc}$, $V_{GS} = 10 \text{ Vdc}$, Peak $I_L = 17 \text{ Apk}$, $L = 5.0 \text{ mH}$, $R_G = 25 \Omega$) | E_{AS} | 722 | mJ |
| Maximum Lead Temperature for Soldering Purposes, 1/8 in from case for 10 seconds | T_L | 260 | $^\circ\text{C}$ |

Stresses exceeding those listed in the Maximum Ratings table may damage the device. If any of these limits are exceeded, device functionality should not be assumed, damage may occur and reliability may be affected.

1. When surface mounted to an FR4 board using the minimum recommended pad size.
2. When surface mounted to an FR4 board using 0.5 sq. in. drain pad size.
3. Pulse Test: Pulse Width = 300 μs , Duty Cycle = 2%.
4. Current Limited by Internal Lead Wires.

| $V_{(BR)DSS}$ | $R_{DS(on)}$ TYP | I_D MAX |
|---------------|-----------------------|-----------|
| 30 V | 7.8 m Ω @ 10 V | 68 A |

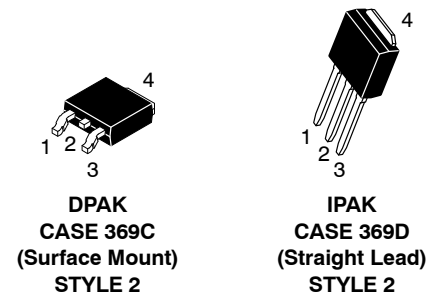
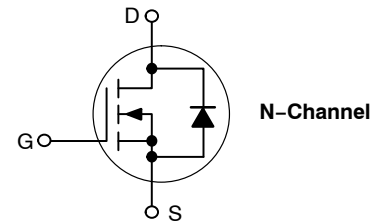

MARKING DIAGRAMS & PIN ASSIGNMENTS

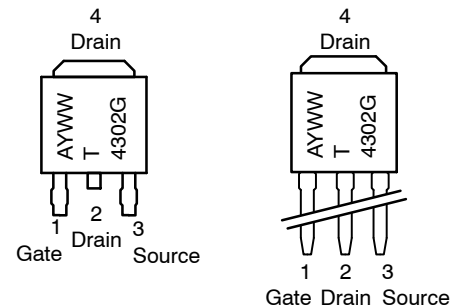

- A = Assembly Location*
- Y = Year
- WW = Work Week
- T4302 = Device Code
- G = Pb-Free Package

* The Assembly Location code (A) is front side optional. In cases where the Assembly Location is stamped in the package, the front side assembly code may be blank.

ORDERING INFORMATION

See detailed ordering and shipping information in the package dimensions section on page 5 of this data sheet.

NTD4302

ELECTRICAL CHARACTERISTICS (T_J = 25°C unless otherwise noted)

| Characteristic | Symbol | Min | Typ | Max | Unit |
|----------------|--------|-----|-----|-----|------|
|----------------|--------|-----|-----|-----|------|

OFF CHARACTERISTICS

| | | | | | |
|--|----------------------|---------|---------|-----------|--------------|
| Drain-Source Breakdown Voltage (V _{GS} = 0 Vdc, I _D = 250 μA) Positive Temperature Coefficient | V _{(BR)DSS} | 30 - | - 25 | - - | Vdc mV/°C |
| Zero Gate Voltage Drain Current (V _{GS} = 0 Vdc, V _{DS} = 30 Vdc, T _J = 25°C) (V _{GS} = 0 Vdc, V _{DS} = 30 Vdc, T _J = 125°C) | I _{DSS} | - - | - - | 1.0 10 | μAdc |
| Gate-Body Leakage Current (V _{GS} = ±20 Vdc, V _{DS} = 0 Vdc) | I _{GSS} | - | - | ±100 | nAdc |

ON CHARACTERISTICS

| | | | | | |
|--|---------------------|-------------|---------------------------|-------------------------|------|
| Gate Threshold Voltage (V _{DS} = V _{GS} , I _D = 250 μAdc) Negative Temperature Coefficient | V _{GS(th)} | 1.0 - | 1.9 -3.8 | 3.0 - | Vdc |
| Static Drain-Source On-State Resistance (V _{GS} = 10 Vdc, I _D = 20 Adc) (V _{GS} = 10 Vdc, I _D = 10 Adc) (V _{GS} = 4.5 Vdc, I _D = 5.0 Adc) | R _{DS(on)} | - - - | 0.0078 0.0078 0.010 | 0.010 0.010 0.013 | Ω |
| Forward Transconductance (V _{DS} = 15 Vdc, I _D = 10 Adc) | g _{FS} | - | 20 | - | Mhos |

DYNAMIC CHARACTERISTICS

| | | | | | | |
|------------------------------|---|------------------|---|------|------|----|
| Input Capacitance | (V _{DS} = 24 Vdc, V _{GS} = 0 Vdc, f = 1.0 MHz) | C _{iss} | - | 2050 | 2400 | pF |
| Output Capacitance | | C _{oss} | - | 640 | 800 | |
| Reverse Transfer Capacitance | | C _{rss} | - | 225 | 310 | |

SWITCHING CHARACTERISTICS (Note 6)

| | | | | | | |
|---------------------|--|----------------------|---|-----|-----|----|
| Turn-On Delay Time | (V _{DD} = 25 Vdc, I _D = 1.0 Adc, V _{GS} = 10 Vdc, R _G = 6.0 Ω) | t _{d(on)} | - | 11 | 20 | ns |
| Rise Time | | t _r | - | 15 | 25 | |
| Turn-Off Delay Time | | t _{d(off)} | - | 85 | 130 | |
| Fall Time | | t _f | - | 55 | 90 | |
| Turn-On Delay Time | (V _{DD} = 25 Vdc, I _D = 1.0 Adc, V _{GS} = 10 Vdc, R _G = 2.5 Ω) | t _{d(on)} | - | 11 | 20 | ns |
| Rise Time | | t _r | - | 13 | 20 | |
| Turn-Off Delay Time | | t _{d(off)} | - | 55 | 90 | |
| Fall Time | | t _f | - | 40 | 75 | |
| Turn-On Delay Time | (V _{DD} = 24 Vdc, I _D = 20 Adc, V _{GS} = 10 Vdc, R _G = 2.5 Ω) | t _{d(on)} | - | 15 | - | ns |
| Rise Time | | t _r | - | 25 | - | |
| Turn-Off Delay Time | | t _{d(off)} | - | 40 | - | |
| Fall Time | | t _f | - | 58 | - | |
| Gate Charge | (V _{DS} = 24 Vdc, I _D = 2.0 Adc, V _{GS} = 10 Vdc) | Q _T | - | 55 | 80 | nC |
| | | Q _{gs} (Q1) | - | 5.5 | - | |
| | | Q _{gd} (Q2) | - | 15 | - | |

BODY-DRAIN DIODE RATINGS (Note 5)

| | | | | | | |
|--|--|-----------------|----------------------|---------------|-----|----|
| Diode Forward On-Voltage (I _S = 2.3 Adc, V _{GS} = 0 Vdc) (I _S = 20 Adc, V _{GS} = 0 Vdc) (I _S = 2.3 Adc, V _{GS} = 0 Vdc, T _J = 125°C) | V _{SD} | - - - | 0.75 0.90 0.65 | 1.0 - - | Vdc | |
| Reverse Recovery Time | (I _S = 2.3 Adc, V _{GS} = 0 Vdc, di _S /dt = 100 A/μs) | t _{rr} | - | 39 | 65 | ns |
| | | t _a | - | 20 | - | |
| | | t _b | - | 19 | - | |
| Reverse Recovery Stored Charge | Q _{rr} | - | 0.043 | - | μC | |

Product parametric performance is indicated in the Electrical Characteristics for the listed test conditions, unless otherwise noted. Product performance may not be indicated by the Electrical Characteristics if operated under different conditions.

5. Indicates Pulse Test: Pulse Width = 300 μsec max, Duty Cycle ≤ 2%.

6. Switching characteristics are independent of operating junction temperature.

TYPICAL CHARACTERISTICS

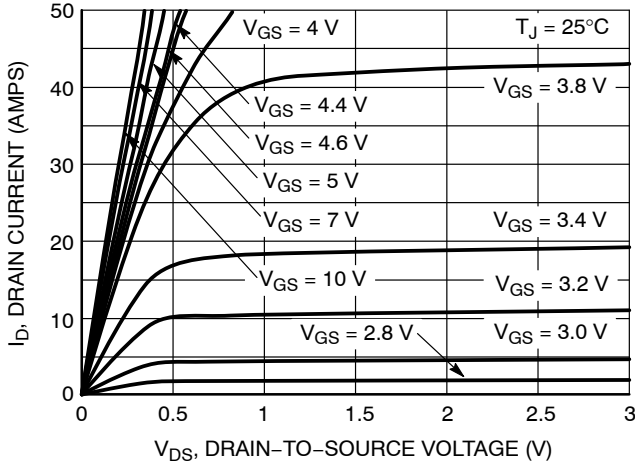

Figure 1. On-Region Characteristics

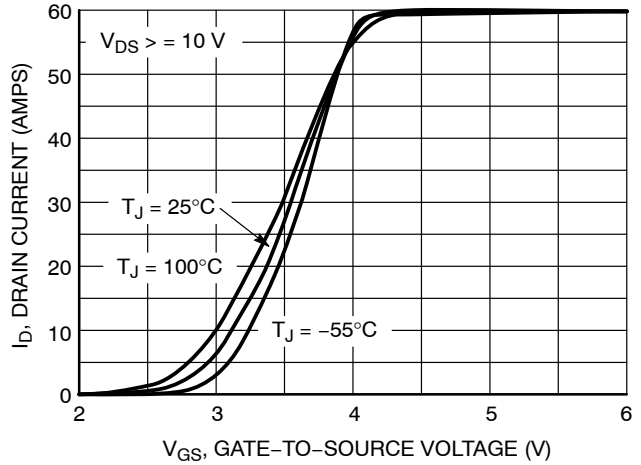

Figure 2. Transfer Characteristics

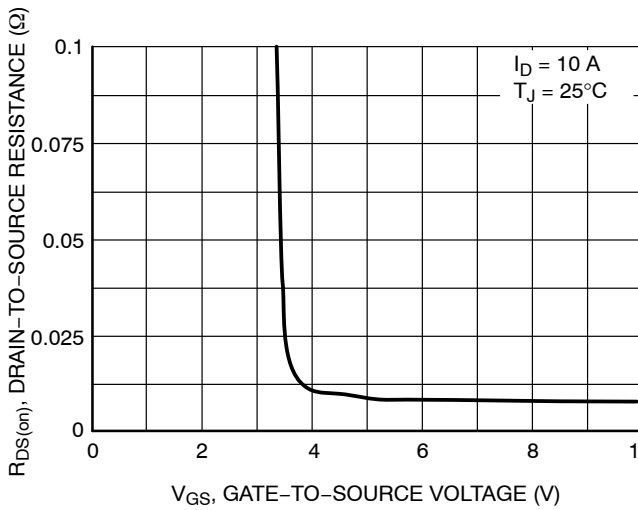

Figure 3. On-Resistance vs. Gate-to-Source Voltage

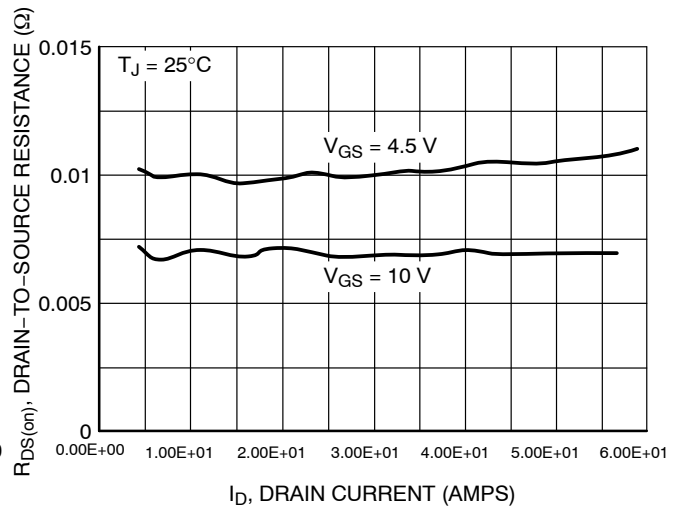

Figure 4. On-Resistance vs. Drain Current and Gate Voltage

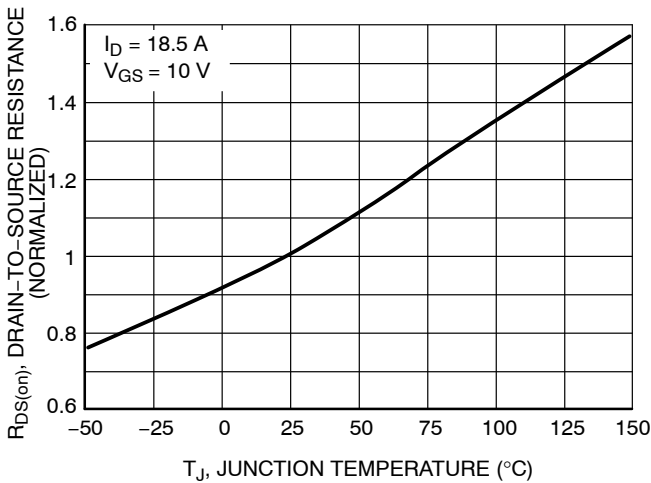

Figure 5. On-Resistance Variation with Temperature

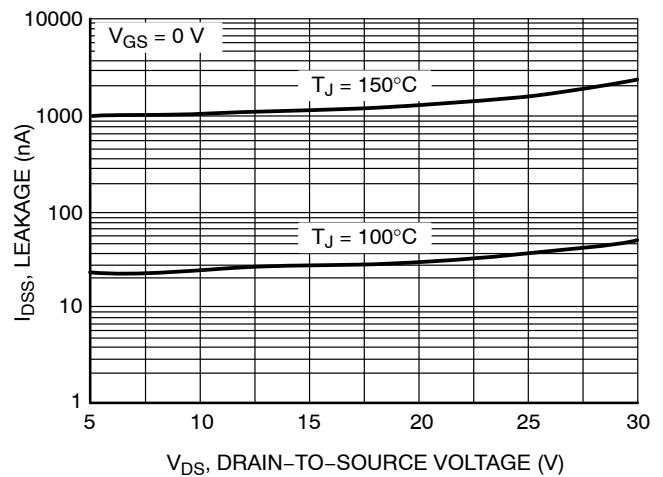

Figure 6. Drain-to-Source Leakage Current vs. Voltage

TYPICAL CHARACTERISTICS

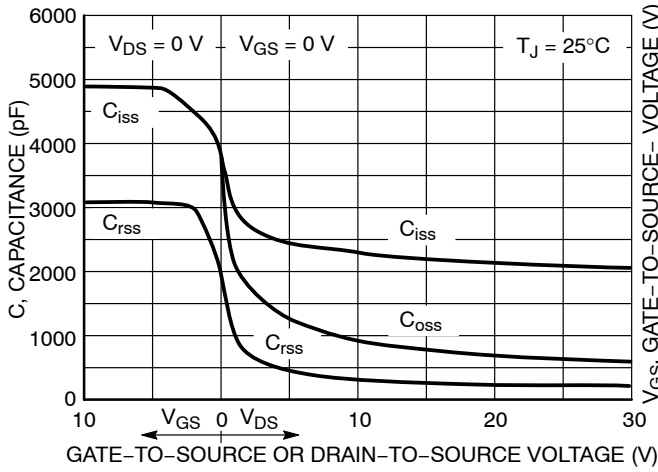

Figure 7. Capacitance Variation

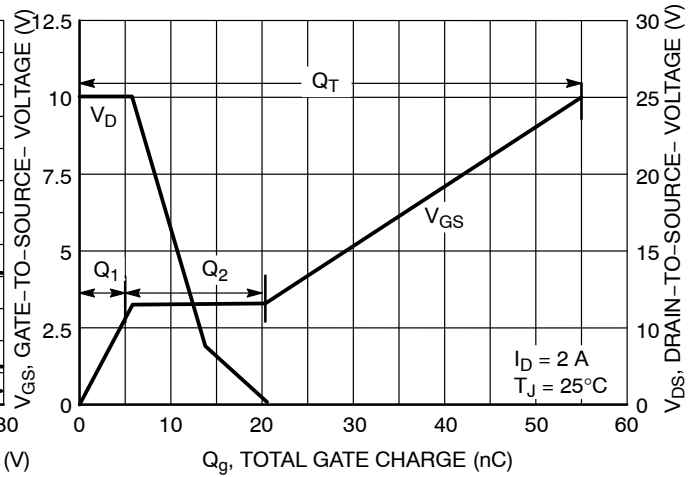

Figure 8. Gate-to-Source and Drain-to-Source Voltage vs. Total Charge

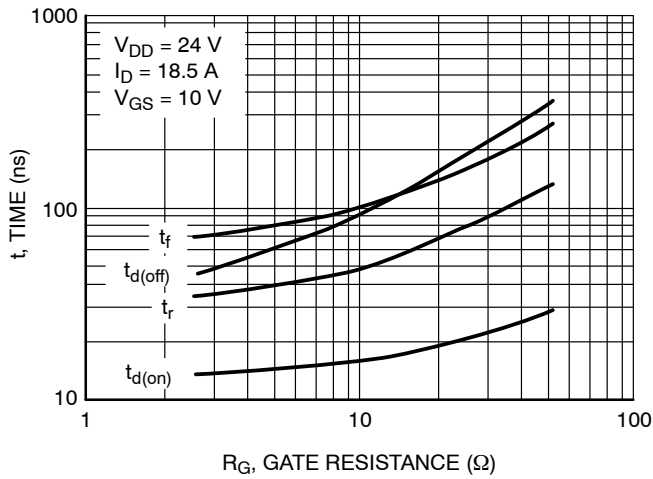

Figure 9. Resistive Switching Time Variation vs. Gate Resistance

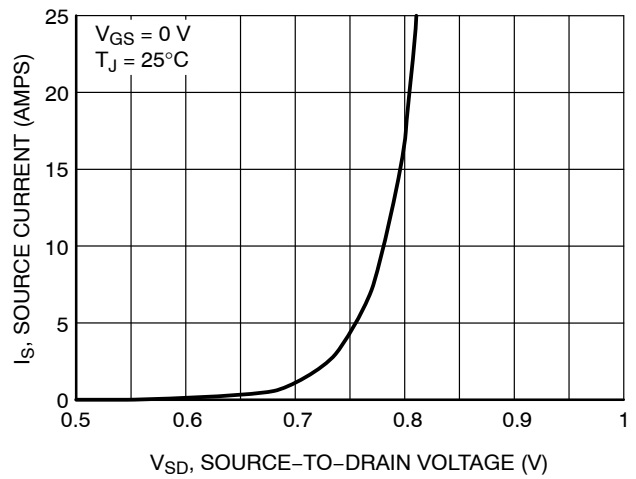

Figure 10. Diode Forward Voltage vs. Current

NTD4302

TYPICAL CHARACTERISTICS

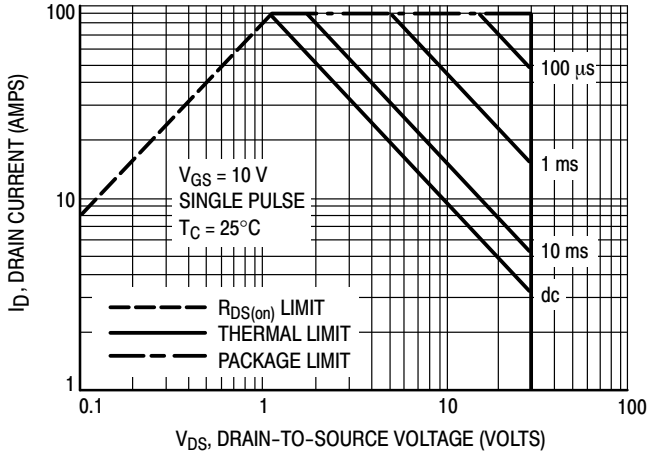

Figure 11. Maximum Rated Forward Biased Safe Operating Area

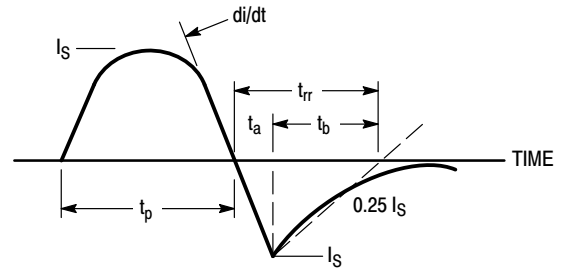

Figure 12. Diode Reverse Recovery Waveform

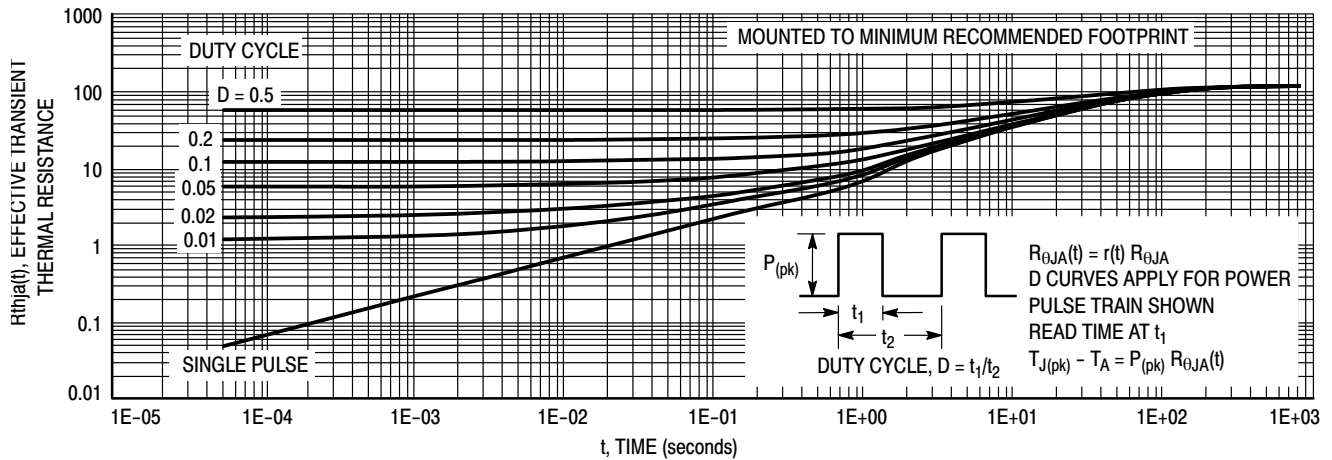

Figure 13. Thermal Response - Various Duty Cycles

ORDERING INFORMATION

| Device | Package Type | Package | Shipping [†] |
|------------|--------------|-------------------|-----------------------|
| NTD4302G | DPAK | 369C (Pb-Free) | 75 Units / Rail |
| NTD4302-1G | IPAK | 369D (Pb-Free) | 75 Units / Rail |
| NTD4302T4G | DPAK | 369C (Pb-Free) | 2500 Tape & Reel |

[†]For information on tape and reel specifications, including part orientation and tape sizes, please refer to our Tape and Reel Packaging Specifications Brochure, BRD8011/D.

MECHANICAL CASE OUTLINE

PACKAGE DIMENSIONS

ON Semiconductor®



IPAK CASE 369D-01 ISSUE C

DATE 15 DEC 2010

SCALE 1:1



- NOTES:
- DIMENSIONING AND TOLERANCING PER ANSI Y14.5M, 1982.
 - CONTROLLING DIMENSION: INCH.

| DIM | INCHES | | MILLIMETERS | |
|-----|--------|-------|-------------|------|
| | MIN | MAX | MIN | MAX |
| A | 0.235 | 0.245 | 5.97 | 6.35 |
| B | 0.250 | 0.265 | 6.35 | 6.73 |
| C | 0.086 | 0.094 | 2.19 | 2.38 |
| D | 0.027 | 0.035 | 0.69 | 0.88 |
| E | 0.018 | 0.023 | 0.46 | 0.58 |
| F | 0.037 | 0.045 | 0.94 | 1.14 |
| G | 0.090 | BSC | 2.29 | BSC |
| H | 0.034 | 0.040 | 0.87 | 1.01 |
| J | 0.018 | 0.023 | 0.46 | 0.58 |
| K | 0.350 | 0.380 | 8.89 | 9.65 |
| R | 0.180 | 0.215 | 4.45 | 5.45 |
| S | 0.025 | 0.040 | 0.63 | 1.01 |
| V | 0.035 | 0.050 | 0.89 | 1.27 |
| Z | 0.155 | --- | 3.93 | --- |

- | | | | |
|--|---|--|--|
| <p>STYLE 1: PIN 1. BASE 2. COLLECTOR 3. EMITTER 4. COLLECTOR</p> | <p>STYLE 2: PIN 1. GATE 2. DRAIN 3. SOURCE 4. DRAIN</p> | <p>STYLE 3: PIN 1. ANODE 2. CATHODE 3. ANODE 4. CATHODE</p> | <p>STYLE 4: PIN 1. CATHODE 2. ANODE 3. GATE 4. ANODE</p> |
| <p>STYLE 5: PIN 1. GATE 2. ANODE 3. CATHODE 4. ANODE</p> | <p>STYLE 6: PIN 1. MT1 2. MT2 3. GATE 4. MT2</p> | <p>STYLE 7: PIN 1. GATE 2. COLLECTOR 3. EMITTER 4. COLLECTOR</p> | |

MARKING DIAGRAMS



- xxxxxxxx = Device Code
A = Assembly Location
IL = Wafer Lot
Y = Year
WW = Work Week

| | | |
|------------------|-----------------------------|--|
| DOCUMENT NUMBER: | 98AON10528D | Electronic versions are uncontrolled except when accessed directly from the Document Repository. Printed versions are uncontrolled except when stamped "CONTROLLED COPY" in red. |
| DESCRIPTION: | IPAK (DPAK INSERTION MOUNT) | PAGE 1 OF 1 |

ON Semiconductor and are trademarks of Semiconductor Components Industries, LLC dba ON Semiconductor or its subsidiaries in the United States and/or other countries. ON Semiconductor reserves the right to make changes without further notice to any products herein. ON Semiconductor makes no warranty, representation or guarantee regarding the suitability of its products for any particular purpose, nor does ON Semiconductor assume any liability arising out of the application or use of any product or circuit, and specifically disclaims any and all liability, including without limitation special, consequential or incidental damages. ON Semiconductor does not convey any license under its patent rights nor the rights of others.

MECHANICAL CASE OUTLINE

PACKAGE DIMENSIONS

ON Semiconductor®



SCALE 1:1

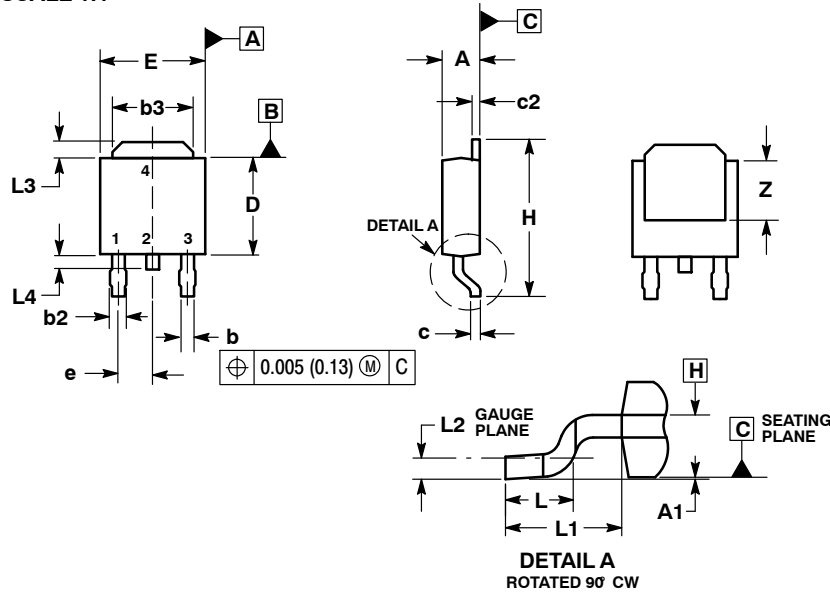

DPAK (SINGLE GAUGE)

CASE 369AA-01

ISSUE B

DATE 03 JUN 2010

NOTES:

- DIMENSIONING AND TOLERANCING PER ASME Y14.5M, 1994.
- CONTROLLING DIMENSION: INCHES.
- THERMAL PAD CONTOUR OPTIONAL WITHIN DIMENSIONS b3, L3 and Z.
- DIMENSIONS D AND E DO NOT INCLUDE MOLD FLASH, PROTRUSIONS, OR BURRS. MOLD FLASH, PROTRUSIONS, OR GATE BURRS SHALL NOT EXCEED 0.006 INCHES PER SIDE.
- DIMENSIONS D AND E ARE DETERMINED AT THE OUTERMOST EXTREMES OF THE PLASTIC BODY.
- DATUMS A AND B ARE DETERMINED AT DATUM PLANE H.

| DIM | INCHES | | MILLIMETERS | |
|-----|-----------|-------|-------------|-------|
| | MIN | MAX | MIN | MAX |
| A | 0.086 | 0.094 | 2.18 | 2.38 |
| A1 | 0.000 | 0.005 | 0.00 | 0.13 |
| b | 0.025 | 0.035 | 0.63 | 0.89 |
| b2 | 0.030 | 0.045 | 0.76 | 1.14 |
| b3 | 0.180 | 0.215 | 4.57 | 5.46 |
| c | 0.018 | 0.024 | 0.46 | 0.61 |
| c2 | 0.018 | 0.024 | 0.46 | 0.61 |
| D | 0.235 | 0.245 | 5.97 | 6.22 |
| E | 0.250 | 0.265 | 6.35 | 6.73 |
| e | 0.090 BSC | | 2.29 BSC | |
| H | 0.370 | 0.410 | 9.40 | 10.41 |
| L | 0.055 | 0.070 | 1.40 | 1.78 |
| L1 | 0.108 REF | | 2.74 REF | |
| L2 | 0.020 BSC | | 0.51 BSC | |
| L3 | 0.035 | 0.050 | 0.89 | 1.27 |
| L4 | --- | 0.040 | --- | 1.01 |
| Z | 0.155 | --- | 3.93 | --- |

- | | | | |
|--|---|--|--|
| <p>STYLE 1: PIN 1. BASE 2. COLLECTOR 3. EMITTER 4. COLLECTOR</p> | <p>STYLE 2: PIN 1. GATE 2. DRAIN 3. SOURCE 4. DRAIN</p> | <p>STYLE 3: PIN 1. ANODE 2. CATHODE 3. ANODE 4. CATHODE</p> | <p>STYLE 4: PIN 1. CATHODE 2. ANODE 3. GATE 4. ANODE</p> |
| <p>STYLE 5: PIN 1. GATE 2. ANODE 3. CATHODE 4. ANODE</p> | <p>STYLE 6: PIN 1. MT1 2. MT2 3. GATE 4. MT2</p> | <p>STYLE 7: PIN 1. GATE 2. COLLECTOR 3. EMITTER 4. COLLECTOR</p> | |

GENERIC MARKING DIAGRAM*



IC Discrete

- XXXXXX = Device Code
- A = Assembly Location
- L = Wafer Lot
- Y = Year
- WW = Work Week
- G = Pb-Free Package

*This information is generic. Please refer to device data sheet for actual part marking.

SOLDERING FOOTPRINT*



SCALE 3:1 (mm/inches)

*For additional information on our Pb-Free strategy and soldering details, please download the ON Semiconductor Soldering and Mounting Techniques Reference Manual, SOLDERRM/D.

| | | |
|------------------|---------------------|--|
| DOCUMENT NUMBER: | 98AON13126D | Electronic versions are uncontrolled except when accessed directly from the Document Repository. Printed versions are uncontrolled except when stamped "CONTROLLED COPY" in red. |
| DESCRIPTION: | DPAK (SINGLE GAUGE) | PAGE 1 OF 1 |

ON Semiconductor and ON are trademarks of Semiconductor Components Industries, LLC dba ON Semiconductor or its subsidiaries in the United States and/or other countries. ON Semiconductor reserves the right to make changes without further notice to any products herein. ON Semiconductor makes no warranty, representation or guarantee regarding the suitability of its products for any particular purpose, nor does ON Semiconductor assume any liability arising out of the application or use of any product or circuit, and specifically disclaims any and all liability, including without limitation special, consequential or incidental damages. ON Semiconductor does not convey any license under its patent rights nor the rights of others.

onsemi, **Onsemi**, and other names, marks, and brands are registered and/or common law trademarks of Semiconductor Components Industries, LLC dba "**onsemi**" or its affiliates and/or subsidiaries in the United States and/or other countries. **onsemi** owns the rights to a number of patents, trademarks, copyrights, trade secrets, and other intellectual property. A listing of **onsemi**'s product/patent coverage may be accessed at www.onsemi.com/site/pdf/Patent-Marking.pdf. **onsemi** reserves the right to make changes at any time to any products or information herein, without notice. The information herein is provided "as-is" and **onsemi** makes no warranty, representation or guarantee regarding the accuracy of the information, product features, availability, functionality, or suitability of its products for any particular purpose, nor does **onsemi** assume any liability arising out of the application or use of any product or circuit, and specifically disclaims any and all liability, including without limitation special, consequential or incidental damages. Buyer is responsible for its products and applications using **onsemi** products, including compliance with all laws, regulations and safety requirements or standards, regardless of any support or applications information provided by **onsemi**. "Typical" parameters which may be provided in **onsemi** data sheets and/or specifications can and do vary in different applications and actual performance may vary over time. All operating parameters, including "Typicals" must be validated for each customer application by customer's technical experts. **onsemi** does not convey any license under any of its intellectual property rights nor the rights of others. **onsemi** products are not designed, intended, or authorized for use as a critical component in life support systems or any FDA Class 3 medical devices or medical devices with a same or similar classification in a foreign jurisdiction or any devices intended for implantation in the human body. Should Buyer purchase or use **onsemi** products for any such unintended or unauthorized application, Buyer shall indemnify and hold **onsemi** and its officers, employees, subsidiaries, affiliates, and distributors harmless against all claims, costs, damages, and expenses, and reasonable attorney fees arising out of, directly or indirectly, any claim of personal injury or death associated with such unintended or unauthorized use, even if such claim alleges that **onsemi** was negligent regarding the design or manufacture of the part. **onsemi** is an Equal Opportunity/Affirmative Action Employer. This literature is subject to all applicable copyright laws and is not for resale in any manner.

ADDITIONAL INFORMATION

TECHNICAL PUBLICATIONS:

Technical Library: www.onsemi.com/design/resources/technical-documentation
onsemi Website: www.onsemi.com

ONLINE SUPPORT: www.onsemi.com/support

For additional information, please contact your local Sales Representative at www.onsemi.com/support/sales