

NCP7800

1.0 A Positive Voltage Regulators

The NCP7800 series consists of 3 pin, fixed output, positive linear voltage regulators, suitable for a wide variety of applications. These regulators are extremely rugged, incorporating internal current limiting, thermal shutdown and safe-area compensation. With adequate heat sinking they can deliver output currents in excess of 1.0 A. Designed as direct replacements for the popular MC7800 family, these products offer enhanced ESD protection.

Features

- Output Current in Excess of 1.0 A
- No External Components Required
- Internal Thermal Overload Protection
- Internal Short Circuit Current Limiting
- Output Transistor Safe-Area Compensation
- Output Voltage Offered in 4% Tolerance
- Available in Standard 3-Lead Transistor Packages
- For Tighter Tolerances and Extended Operating Range Refer to MC7800
- Enhanced ESD Tolerance: HBM 4 kV (5 V and 8 V Options), 3 kV (12 V and 15 V Options), and MM 400 V
- These are Pb-Free Devices

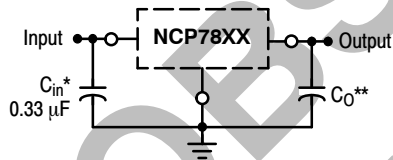

A common ground is required between the input and the output voltages. The input voltage must remain typically 2.0 V above the output voltage even during the low point on the input ripple voltage.

XX These two digits of the type number indicate nominal voltage.

* C_{in} is required if regulator is located an appreciable distance from power supply filter.

** C_o is not needed for stability; however, it does improve transient response. Values of less than 0.1 μ F could cause instability.

Figure 1. Application Schematic



ON Semiconductor®

<http://onsemi.com>

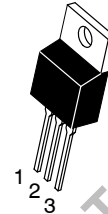

TO-220-3
T SUFFIX
CASE 221AB

PIN CONNECTIONS

- Pin 1. Input
2. Ground
3. Output

Heatsink surface
connected to Pin 2

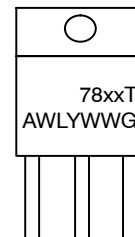

MARKING DIAGRAM

- xx = 05, 08, 12 or 15
A = Assembly Location
WL, L = Wafer Lot
Y = Year
WW = Work Week
G = Pb-Free Device

ORDERING INFORMATION

See detailed ordering and shipping information in the package dimensions section on page 11 of this data sheet.

NCP7800

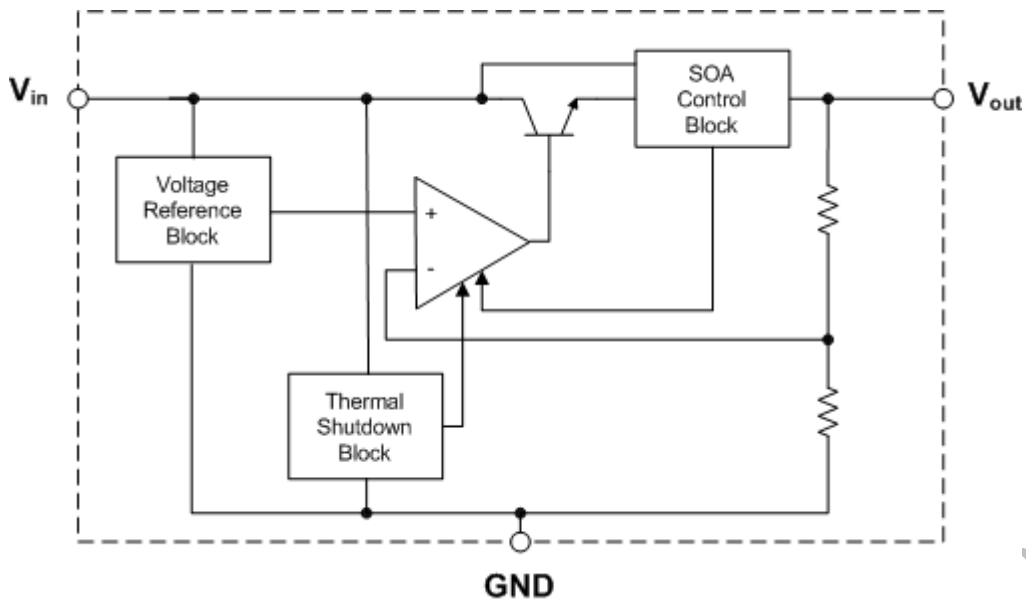

Figure 2. Simplified Block Diagram

Table 1. PIN FUNCTION DESCRIPTION

Pin No.	Pin Name	Description
1	V_{in}	Positive Power Supply Input.
2	GND	Power Supply Ground; Device Substrate.
3	V_{out}	Regulated Output Voltage.

NCP7800

Table 2. ABSOLUTE MAXIMUM RATINGS (Note 1)

Rating	Symbol	Value	Unit
Input Voltage Range (for V_{out} : 5.0 – 15 V)	V_{in}	-0.3 to 35	V
Power Dissipation	P_D	Internally Limited	W
Maximum Junction Temperature	$T_{J(max)}$	150	°C
Storage Temperature Range	T_{stg}	-65 to +150	°C
ESD Capability, Human Body Model (Note 2)	ESD _{HBM}	4	kV
NCP7805, NCP7808 NCP7812, NCP7815		3	
ESD Capability, Machine Model (Note 2)	ESD _{MM}	400	V

Stresses exceeding Maximum Ratings may damage the device. Maximum Ratings are stress ratings only. Functional operation above the Recommended Operating Conditions is not implied. Extended exposure to stresses above the Recommended Operating Conditions may affect device reliability.

1. Refer to ELECTRICAL CHARACTERISTICS and APPLICATION INFORMATION for Safe Operating Area.
2. This device series incorporates ESD protection and is tested by the following methods:
 ESD Human Body Model tested per EIA/JESD22-A114
 ESD Machine Model tested per EIA/JESD22-A115
 Latchup Current Maximum Rating: ≤ 150 mA per JEDEC standard: JESD78

Table 3. THERMAL CHARACTERISTICS

Rating	Symbol	Value	Unit
Thermal Characteristics, TO-220-3 (Note 3) Thermal Resistance, Junction-to-Case Thermal Resistance, Junction-to-Air (Note 4)	$R_{\theta JC}$ $R_{\theta JA}$	7.5 65	°C/W

3. Refer to ELECTRICAL CHARACTERISTICS and APPLICATION INFORMATION for Safe Operating Area.
4. Value based on thermal measurement in a test socket.

Table 4. OPERATING RANGES (Note 5)

Rating	Symbol	Min	Max	Unit
Input Voltage (Note 6) (for V_{out} : 5.0 – 15 V)	V_{in}	7.0	35	V
Junction Temperature	T_J	0	125	°C

5. Refer to ELECTRICAL CHARACTERISTICS and APPLICATION INFORMATION for Safe Operating Area.
6. Minimum $V_{in} = 7.0$ V or $(V_{out} + V_{DO})$, whichever is higher.

NCP7800

Table 5. ELECTRICAL CHARACTERISTICS ($V_{in} = 10\text{ V}$, $I_O = 500\text{ mA}$, $T_J = 0^\circ\text{C}$ to 125°C , unless otherwise noted) (Note 7)

Characteristic	Symbol	NCP7805			Unit
		Min	Typ	Max	
Output Voltage ($T_J = 25^\circ\text{C}$)	V_O	4.8	5.0	5.2	Vdc
Output Voltage ($5.0\text{ mA} \leq I_O \leq 1.0\text{ A}$, $P_D \leq 15\text{ W}$) $7.0\text{ Vdc} \leq V_{in} \leq 20\text{ Vdc}$	V_O	4.75	5.0	5.25	Vdc
Line Regulation ($T_J = 25^\circ\text{C}$) $7.5\text{ Vdc} \leq V_{in} \leq 20\text{ Vdc}$ $8.0\text{ Vdc} \leq V_{in} \leq 12\text{ Vdc}$	Reg_{line}	– –	1.1 0.6	100 50	mV
Load Regulation ($T_J = 25^\circ\text{C}$) $5.0\text{ mA} \leq I_O \leq 1.0\text{ A}$ $5.0\text{ mA} \leq I_O \leq 1.5\text{ A}$	Reg_{load}	– –	1.5 2.9	50 100	mV
Quiescent Current ($T_J = 25^\circ\text{C}$)	I_B	–	3.0	8	mA
Quiescent Current Change $7.0\text{ Vdc} \leq V_{in} \leq 25\text{ Vdc}$ $5.0\text{ mA} \leq I_O \leq 1.0\text{ A}$	ΔI_B	– –	0.28 0.07	1.3 0.5	mA
Ripple Rejection (Note 8) $8.0\text{ Vdc} \leq V_{in} \leq 18\text{ Vdc}$, $f = 120\text{ Hz}$	RR	62	75	–	dB
Dropout Voltage ($I_O = 1.0\text{ A}$, $T_J = 25^\circ\text{C}$) (Note 8)	$V_I - V_O$	–	2.0	–	Vdc
Output Noise Voltage ($T_J = 25^\circ\text{C}$) (Note 8) $10\text{ Hz} \leq f \leq 100\text{ kHz}$	V_n	–	6.8	–	$\mu\text{V}/V_O$
Output Resistance $f = 1.0\text{ kHz}$ (Note 8)	r_O	–	2.2	–	$\text{m}\Omega$
Short Circuit Current Limit ($T_J = 25^\circ\text{C}$) (Note 8) $V_{in} = 35\text{ Vdc}$	I_{sc}	–	0.3	–	A
Peak Output Current ($T_J = 25^\circ\text{C}$) (Note 8)	I_{max}	–	2.4	–	A
Average Temperature Coefficient of Output Voltage (Note 8)	TCV_O	–	0.13	–	$\text{mV}/^\circ\text{C}$

7. Performance guaranteed over the indicated operating temperature range by design and/or characterization, production tested at $T_J = T_A = 25^\circ\text{C}$. Low duty cycle pulse techniques are used during testing to maintain the junction temperature as close to ambient as possible.
8. Value based on design and/or characterization.

NCP7800

Table 6. ELECTRICAL CHARACTERISTICS ($V_{in} = 14\text{ V}$, $I_O = 500\text{ mA}$, $T_J = 0^\circ\text{C}$ to 125°C , unless otherwise noted) (Note 9)

Characteristic	Symbol	NCP7808			Unit
		Min	Typ	Max	
Output Voltage ($T_J = 25^\circ\text{C}$)	V_O	7.68	8.0	8.32	Vdc
Output Voltage ($5.0\text{ mA} \leq I_O \leq 1.0\text{ A}$, $P_D \leq 15\text{ W}$) $10.5\text{ Vdc} \leq V_{in} \leq 23\text{ Vdc}$	V_O	7.60	8.0	8.40	Vdc
Line Regulation ($T_J = 25^\circ\text{C}$) $10.5\text{ Vdc} \leq V_{in} \leq 25\text{ Vdc}$ $11.0\text{ Vdc} \leq V_{in} \leq 17\text{ Vdc}$	Reg_{line}	– –	1.8 1.0	160 80	mV
Load Regulation ($T_J = 25^\circ\text{C}$) $5.0\text{ mA} \leq I_O \leq 1.5\text{ A}$	Reg_{load}	–	3.7	160	mV
Quiescent Current ($T_J = 25^\circ\text{C}$)	I_B	–	3.0	8.0	mA
Quiescent Current Change $10.5\text{ Vdc} \leq V_{in} \leq 25\text{ Vdc}$ $5.0\text{ mA} \leq I_O \leq 1.0\text{ A}$	ΔI_B	– –	– –	1.0 0.5	mA
Ripple Rejection (Note 10) $11.5\text{ Vdc} \leq V_{in} \leq 21.5\text{ Vdc}$, $f = 120\text{ Hz}$	RR	56	72	–	dB
Dropout Voltage ($I_O = 1.0\text{ A}$, $T_J = 25^\circ\text{C}$) (Note 10)	$V_I - V_O$	–	2.0	–	Vdc
Output Noise Voltage ($T_J = 25^\circ\text{C}$) (Note 10) $10\text{ Hz} \leq f \leq 100\text{ kHz}$	V_n	–	6.8	–	$\mu\text{V}/V_O$
Output Resistance $f = 1.0\text{ kHz}$ (Note 10)	r_O	–	2.7	–	$\text{m}\Omega$
Short Circuit Current Limit ($T_J = 25^\circ\text{C}$) (Note 10) $V_{in} = 35\text{ Vdc}$	I_{SC}	–	0.3	–	A
Peak Output Current ($T_J = 25^\circ\text{C}$) (Note 10)	I_{max}	–	2.4	–	A
Average Temperature Coefficient of Output Voltage (Note 10)	TCV_O	–	0.24	–	$\text{mV}/^\circ\text{C}$

9. Performance guaranteed over the indicated operating temperature range by design and/or characterization, production tested at $T_J = T_A = 25^\circ\text{C}$. Low duty cycle pulse techniques are used during testing to maintain the junction temperature as close to ambient as possible.
10. Value based on design and/or characterization.

NCP7800

Table 7. ELECTRICAL CHARACTERISTICS ($V_{in} = 19\text{ V}$, $I_O = 500\text{ mA}$, $T_J = 0^\circ\text{C}$ to 125°C , unless otherwise noted) (Note 11)

Characteristic	Symbol	NCP7812			Unit
		Min	Typ	Max	
Output Voltage ($T_J = 25^\circ\text{C}$)	V_O	11.52	12	12.48	Vdc
Output Voltage ($5.0\text{ mA} \leq I_O \leq 1.0\text{ A}$, $P_D \leq 15\text{ W}$) $14.5\text{ Vdc} \leq V_{in} \leq 27\text{ Vdc}$	V_O	11.40	12	12.60	Vdc
Line Regulation ($T_J = 25^\circ\text{C}$) $14.5\text{ Vdc} \leq V_{in} \leq 30\text{ Vdc}$ $16\text{ Vdc} \leq V_{in} \leq 22\text{ Vdc}$	Reg_{line}	–	2.7 1.4	240 120	mV
Load Regulation ($T_J = 25^\circ\text{C}$) $5.0\text{ mA} \leq I_O \leq 1.5\text{ A}$	Reg_{load}	–	5.5	240	mV
Quiescent Current ($T_J = 25^\circ\text{C}$)	I_B	–	3.0	8.0	mA
Quiescent Current Change $14.5\text{ Vdc} \leq V_{in} \leq 30\text{ Vdc}$ $5.0\text{ mA} \leq I_O \leq 1.0\text{ A}$	ΔI_B	–	–	1.0 0.5	mA
Ripple Rejection (Note 12) $15\text{ Vdc} \leq V_{in} \leq 25\text{ Vdc}$, $f = 120\text{ Hz}$	RR	55	71	–	dB
Dropout Voltage ($I_O = 1.0\text{ A}$, $T_J = 25^\circ\text{C}$) (Note 12)	$V_I - V_O$	–	2.0	–	Vdc
Output Noise Voltage ($T_J = 25^\circ\text{C}$) (Note 12) $10\text{ Hz} \leq f \leq 100\text{ kHz}$	V_n	–	6.8	–	$\mu\text{V}/V_O$
Output Resistance $f = 1.0\text{ kHz}$ (Note 12)	r_O	–	3.6	–	$\text{m}\Omega$
Short Circuit Current Limit ($T_J = 25^\circ\text{C}$) (Note 12) $V_{in} = 35\text{ Vdc}$	I_{SC}	–	0.3	–	A
Peak Output Current ($T_J = 25^\circ\text{C}$) (Note 12)	I_{max}	–	2.4	–	A
Average Temperature Coefficient of Output Voltage (Note 12)	TCV_O	–	0.47	–	$\text{mV}/^\circ\text{C}$

11. Performance guaranteed over the indicated operating temperature range by design and/or characterization, production tested at $T_J = T_A = 25^\circ\text{C}$. Low duty cycle pulse techniques are used during testing to maintain the junction temperature as close to ambient as possible.
 12. Value based on design and/or characterization.

NCP7800

Table 8. ELECTRICAL CHARACTERISTICS ($V_{in} = 23\text{ V}$, $I_O = 500\text{ mA}$, $T_J = 0^\circ\text{C}$ to 125°C , unless otherwise noted) (Note 13)

Characteristic	Symbol	NCP7815			Unit
		Min	Typ	Max	
Output Voltage ($T_J = 25^\circ\text{C}$)	V_O	14.40	15	15.60	Vdc
Output Voltage ($5.0\text{ mA} \leq I_O \leq 1.0\text{ A}$, $P_D \leq 15\text{ W}$) $17.5\text{ Vdc} \leq V_{in} \leq 30\text{ Vdc}$	V_O	14.25	15	15.75	Vdc
Line Regulation ($T_J = 25^\circ\text{C}$) $17.9\text{ Vdc} \leq V_{in} \leq 30\text{ Vdc}$ $20\text{ Vdc} \leq V_{in} \leq 26\text{ Vdc}$	Reg_{line}	– –	3.3 1.8	300 150	mV
Load Regulation ($T_J = 25^\circ\text{C}$) $5.0\text{ mA} \leq I_O \leq 1.5\text{ A}$	Reg_{load}	–	6.9	300	mV
Quiescent Current ($T_J = 25^\circ\text{C}$)	I_B	–	3.0	8.0	mA
Quiescent Current Change $17.5\text{ Vdc} \leq V_{in} \leq 30\text{ Vdc}$ $5.0\text{ mA} \leq I_O \leq 1.0\text{ A}$	ΔI_B	– –	– –	1.0 0.5	mA
Ripple Rejection (Note 14) $18.5\text{ Vdc} \leq V_{in} \leq 28.5\text{ Vdc}$, $f = 120\text{ Hz}$	RR	54	70	–	dB
Dropout Voltage ($I_O = 1.0\text{ A}$, $T_J = 25^\circ\text{C}$) (Note 14)	$V_I - V_O$	–	2.0	–	Vdc
Output Noise Voltage ($T_J = 25^\circ\text{C}$) (Note 14) $10\text{ Hz} \leq f \leq 100\text{ kHz}$	V_n	–	6.8	–	$\mu\text{V}/V_O$
Output Resistance $f = 1.0\text{ kHz}$ (Note 14)	r_O	–	4.7	–	$\text{m}\Omega$
Short Circuit Current Limit ($T_J = 25^\circ\text{C}$) (Note 14) $V_{in} = 35\text{ Vdc}$	I_{SC}	–	0.3	–	A
Peak Output Current ($T_J = 25^\circ\text{C}$) (Note 14)	I_{max}	–	2.4	–	A
Average Temperature Coefficient of Output Voltage (Note 14)	TCV_O	–	0.42	–	$\text{mV}/^\circ\text{C}$

13. Performance guaranteed over the indicated operating temperature range by design and/or characterization, production tested at $T_J = T_A = 25^\circ\text{C}$. Low duty cycle pulse techniques are used during testing to maintain the junction temperature as close to ambient as possible.
14. Value based on design and/or characterization.

NCP7800

TYPICAL CHARACTERISTICS

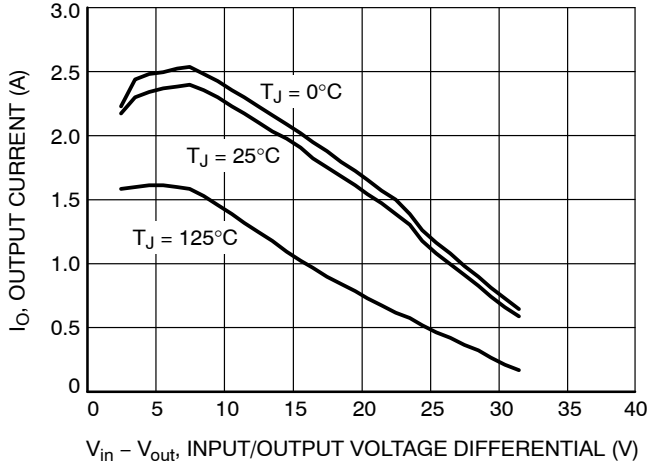

Figure 3. Peak Output Current as a Function of Input/Output Differential Voltage (NCP7805)

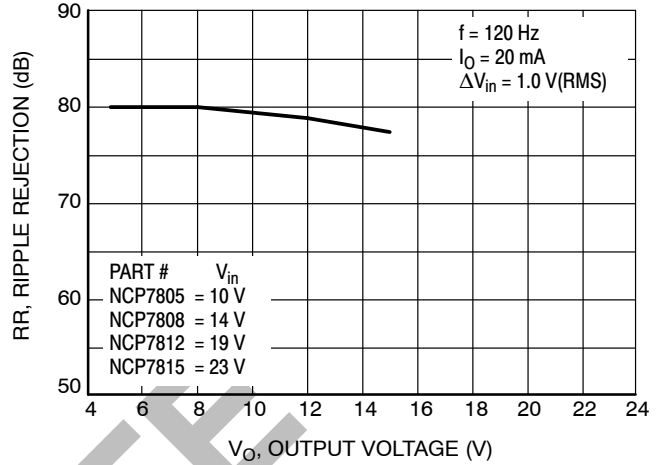

Figure 4. Ripple Rejection as a Function of Output Voltage

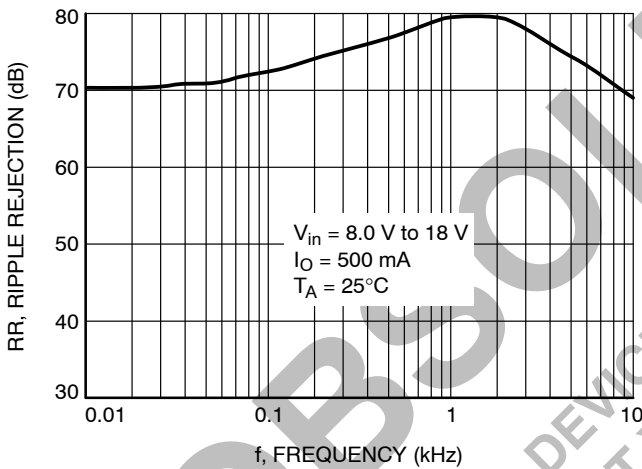

Figure 5. Ripple Rejection as a Function of Frequency (NCP7805)

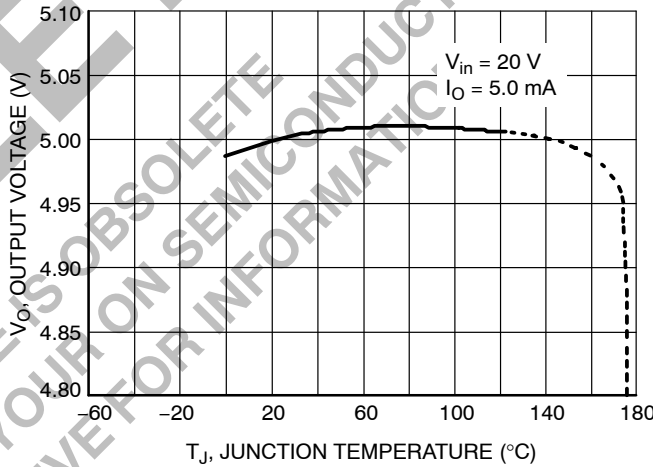

Figure 6. Output Voltage as a Function of Junction Temperature (NCP7805)

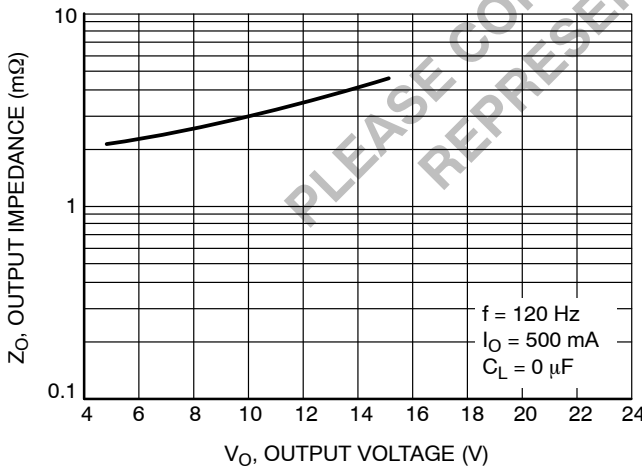

Figure 7. Output Impedance as a Function of Output Voltage

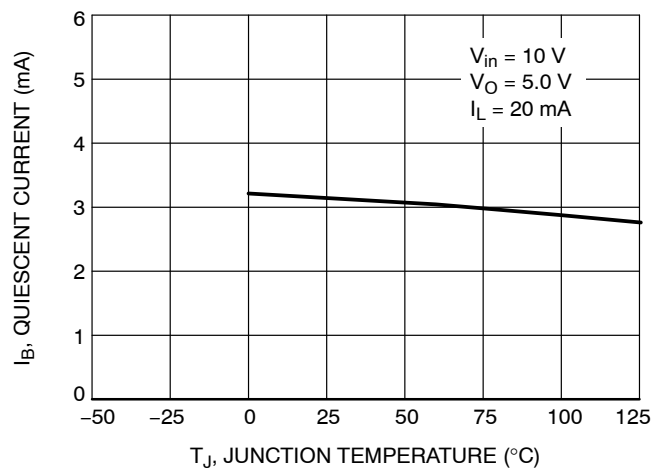

Figure 8. Quiescent Current as a Function of Temperature (NCP7805)

APPLICATIONS INFORMATION

Design Considerations

The NCP7800 Series of fixed voltage regulators are designed with Thermal Overload Protection that shuts down the circuit when subjected to an excessive power overload condition, Internal Short Circuit Protection that limits the maximum current the circuit will pass, and Output Transistor Safe-Area Compensation that reduces the output short circuit current as the voltage across the pass transistor is increased.

In many low current applications, compensation capacitors are not required. However, it is recommended that the regulator input be bypassed with a capacitor if the regulator is connected to the power supply filter with long wire lengths, or if the output load capacitance is large. An

input bypass capacitor should be selected to provide good high-frequency characteristics to insure stable operation under all load conditions. A 0.33 μF or larger tantalum, mylar, or other capacitor having low internal impedance at high frequencies should be chosen. The bypass capacitor should be mounted with the shortest possible leads directly across the regulators input terminals. Normally good construction techniques should be used to minimize ground loops and lead resistance drops since the regulator has no external sense lead.

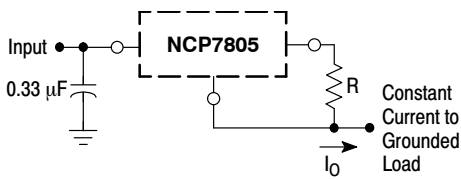

The NCP7800 regulators can also be used as a current source when connected as above. In order to minimize dissipation the NCP7805 is chosen in this application. Resistor R determines the current as follows:

$$I_O = \frac{5.0 \text{ V}}{R} + I_B$$

$$I_B \cong 3.2 \text{ mA over line and load changes.}$$

For example, a 1.0 A current source would require R to be a 5.0 Ω, 10 W resistor and the output voltage compliance would be the input voltage less 7.0 V.

Figure 9. Current Regulator

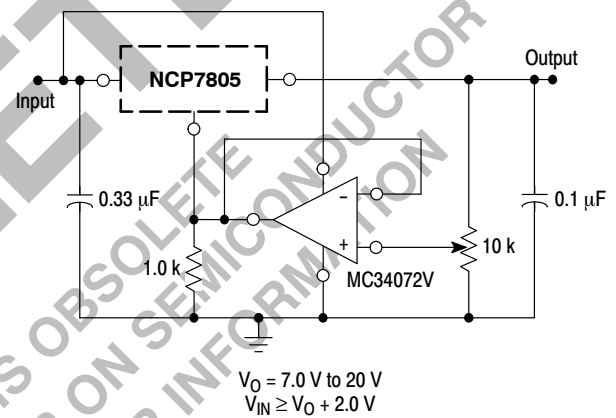

The addition of an operational amplifier allows adjustment to higher or intermediate values while retaining regulation characteristics. The minimum voltage obtainable with this arrangement is 2.0 V greater than the regulator voltage.

Figure 10. Adjustable Output Regulator

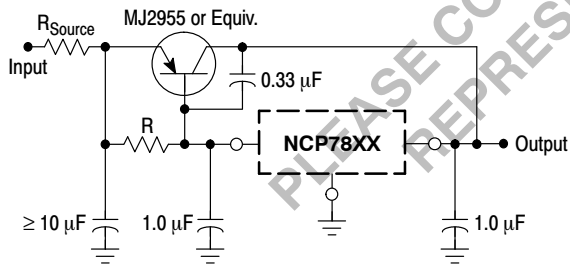

XX = 2 digits of type number indicating voltage.

The NCP7800 series can be current boosted with a PNP transistor. The MJ2955 provides current to 5.0 A. Resistor R in conjunction with the V_{BE} of the PNP determines when the pass transistor begins conducting; this circuit is not short circuit proof. Input/output differential voltage minimum is increased by V_{BE} of the pass transistor.

Figure 11. Current Boost Regulator

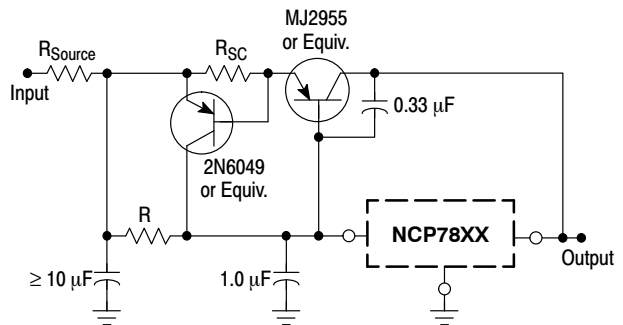

XX = 2 digits of type number indicating voltage.

The circuit of Figure 11 can be modified to provide supply protection against short circuits by adding a short circuit sense resistor, R_{SC}, and an additional PNP transistor. The current sensing PNP must be able to handle the short circuit current of the three-terminal regulator. Therefore, a four-ampere plastic power transistor is specified.

Figure 12. Short Circuit Protection

NCP7800

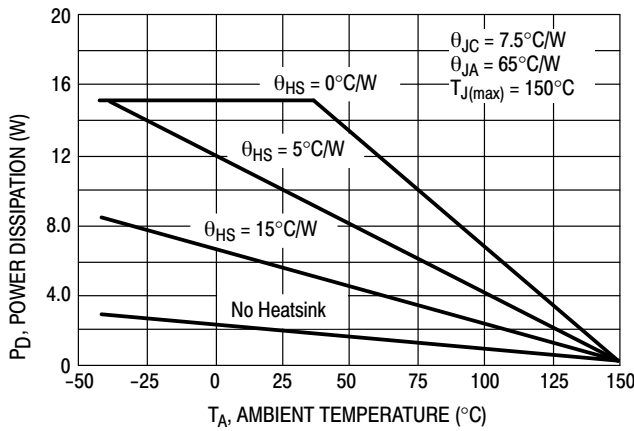

Figure 13. Worst Case Power Dissipation vs. Ambient Temperature (TO-220)

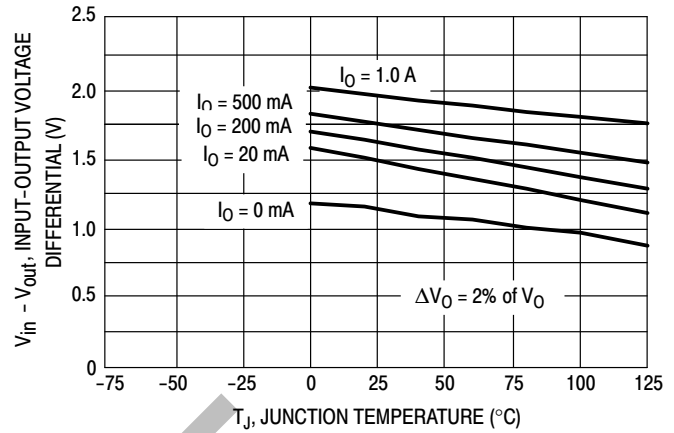

Figure 14. Input Output Differential as a Function of Junction Temperature

Protection Diode

The NCP7800 Series has internal low impedance (about 1 Ω) diode path that normally does not require protection when used in the typical regulator applications. The path connects between output and input and it can withstand a peak surge current of about 5 A for a reasonable time (several milliseconds). Normal cycling of V_{in} cannot generate a current surge of this magnitude for too long time since output capacitor discharges from output to input and follows input voltage therefore the magnitude of reverse current is not so high. However, when V_{in} is shorted or crowbarred to ground and output cap is too large and moreover if higher voltage option is used then the peak of reverse current is much higher than 5 A and lasts more than

several milliseconds. In this case a damage may occur to the regulator.

To protect the regulator the external bypass diode connected between output and input is recommended. The protection diode should be rated for sufficient peak current.

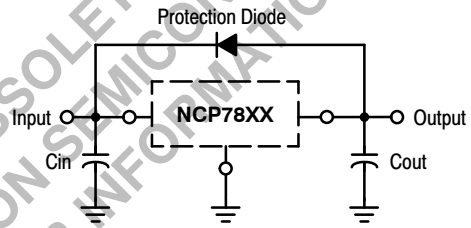

Figure 15. Protection Diode Placement

NCP7800

DEFINITIONS

Line Regulation – The change in output voltage for a change in the input voltage. The measurement is made under conditions of low dissipation or by using pulse techniques such that the average chip temperature is not significantly affected.

Load Regulation – The change in output voltage for a change in load current at constant chip temperature.

Maximum Power Dissipation – The maximum total device dissipation for which the regulator will operate within specifications.

Quiescent Current – That part of the input current that is not delivered to the load.

Output Noise Voltage – The rms ac voltage at the output, with constant load and no input ripple, measured over a specified frequency range.

Long Term Stability – Output voltage stability under accelerated life test conditions with the maximum rated voltage listed in the devices' electrical characteristics and maximum power dissipation.

ORDERING INFORMATION

Device	Nominal Voltage	Operating Temperature Range	Package	Shipping
NCP7805TG	5.0 V	$T_J = 0^{\circ}\text{C to } +125^{\circ}\text{C}$	TO-220 (Pb-Free)	50 Units / Rail
NCP7808TG	8.0 V	$T_J = 0^{\circ}\text{C to } +125^{\circ}\text{C}$	TO-220 (Pb-Free)	50 Units / Rail
NCP7812TG	12 V	$T_J = 0^{\circ}\text{C to } +125^{\circ}\text{C}$	TO-220 (Pb-Free)	50 Units / Rail
NCP7815TG	15 V	$T_J = 0^{\circ}\text{C to } +125^{\circ}\text{C}$	TO-220 (Pb-Free)	50 Units / Rail

MECHANICAL CASE OUTLINE

PACKAGE DIMENSIONS

ON Semiconductor®



TO-220, SINGLE GAUGE CASE 221AB-01 ISSUE A

DATE 16 NOV 2010

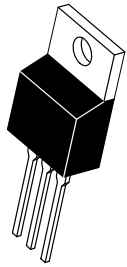

SCALE 1:1

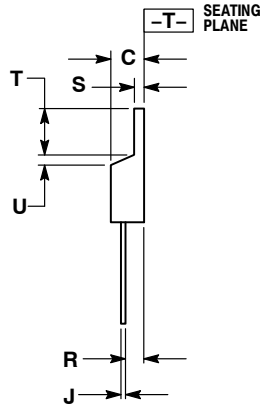
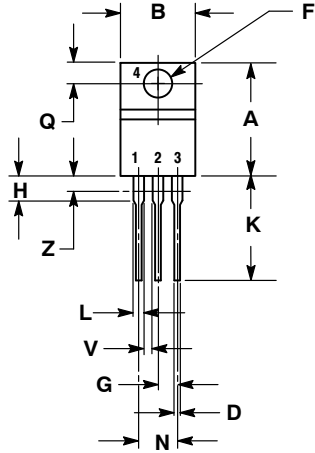

NOTES:

1. DIMENSIONING AND TOLERANCING PER ANSI Y14.5M, 1982.
2. CONTROLLING DIMENSION: INCHES.
3. DIMENSION Z DEFINES A ZONE WHERE ALL BODY AND LEAD IRREGULARITIES ARE ALLOWED.
4. PRODUCT SHIPPED PRIOR TO 2008 HAD DIMENSIONS S = 0.045 - 0.055 INCHES (1.143 - 1.397 MM)

DIM	INCHES		MILLIMETERS	
	MIN	MAX	MIN	MAX
A	0.570	0.620	14.48	15.75
B	0.380	0.405	9.66	10.28
C	0.160	0.190	4.07	4.82
D	0.025	0.035	0.64	0.88
F	0.142	0.147	3.61	3.73
G	0.095	0.105	2.42	2.66
H	0.110	0.155	2.80	3.93
J	0.018	0.025	0.46	0.64
K	0.500	0.562	12.70	14.27
L	0.045	0.060	1.15	1.52
N	0.190	0.210	4.83	5.33
Q	0.100	0.120	2.54	3.04
R	0.080	0.110	2.04	2.79
S	0.020	0.024	0.508	0.61
T	0.235	0.255	5.97	6.47
U	0.000	0.050	0.00	1.27
V	0.045	---	1.15	---
Z	---	0.080	---	2.04

STYLE 1:

- PIN 1. BASE
- 2. COLLECTOR
- 3. EMITTER
- 4. COLLECTOR

STYLE 2:

- PIN 1. BASE
- 2. EMITTER
- 3. COLLECTOR
- 4. EMITTER

STYLE 3:

- PIN 1. CATHODE
- 2. ANODE
- 3. GATE
- 4. ANODE

STYLE 4:

- PIN 1. MAIN TERMINAL 1
- 2. MAIN TERMINAL 2
- 3. GATE
- 4. MAIN TERMINAL 2

STYLE 5:

- PIN 1. GATE
- 2. DRAIN
- 3. SOURCE
- 4. DRAIN

STYLE 6:

- PIN 1. ANODE
- 2. CATHODE
- 3. ANODE
- 4. CATHODE

STYLE 7:

- PIN 1. CATHODE
- 2. ANODE
- 3. CATHODE
- 4. ANODE

STYLE 8:

- PIN 1. CATHODE
- 2. ANODE
- 3. EXTERNAL TRIP/DELAY
- 4. ANODE

STYLE 9:

- PIN 1. GATE
- 2. COLLECTOR
- 3. EMITTER
- 4. COLLECTOR

STYLE 10:

- PIN 1. GATE
- 2. SOURCE
- 3. DRAIN
- 4. SOURCE

STYLE 11:

- PIN 1. DRAIN
- 2. SOURCE
- 3. GATE
- 4. SOURCE

DOCUMENT NUMBER:	98AON23085D	Electronic versions are uncontrolled except when accessed directly from the Document Repository. Printed versions are uncontrolled except when stamped "CONTROLLED COPY" in red.
DESCRIPTION:	TO-220, SINGLE GAUGE	PAGE 1 OF 1

ON Semiconductor and are trademarks of Semiconductor Components Industries, LLC dba ON Semiconductor or its subsidiaries in the United States and/or other countries. ON Semiconductor reserves the right to make changes without further notice to any products herein. ON Semiconductor makes no warranty, representation or guarantee regarding the suitability of its products for any particular purpose, nor does ON Semiconductor assume any liability arising out of the application or use of any product or circuit, and specifically disclaims any and all liability, including without limitation special, consequential or incidental damages. ON Semiconductor does not convey any license under its patent rights nor the rights of others.

onsemi, **Onsemi**, and other names, marks, and brands are registered and/or common law trademarks of Semiconductor Components Industries, LLC dba "**onsemi**" or its affiliates and/or subsidiaries in the United States and/or other countries. **onsemi** owns the rights to a number of patents, trademarks, copyrights, trade secrets, and other intellectual property. A listing of **onsemi**'s product/patent coverage may be accessed at www.onsemi.com/site/pdf/Patent-Marking.pdf. **onsemi** reserves the right to make changes at any time to any products or information herein, without notice. The information herein is provided "as-is" and **onsemi** makes no warranty, representation or guarantee regarding the accuracy of the information, product features, availability, functionality, or suitability of its products for any particular purpose, nor does **onsemi** assume any liability arising out of the application or use of any product or circuit, and specifically disclaims any and all liability, including without limitation special, consequential or incidental damages. Buyer is responsible for its products and applications using **onsemi** products, including compliance with all laws, regulations and safety requirements or standards, regardless of any support or applications information provided by **onsemi**. "Typical" parameters which may be provided in **onsemi** data sheets and/or specifications can and do vary in different applications and actual performance may vary over time. All operating parameters, including "Typicals" must be validated for each customer application by customer's technical experts. **onsemi** does not convey any license under any of its intellectual property rights nor the rights of others. **onsemi** products are not designed, intended, or authorized for use as a critical component in life support systems or any FDA Class 3 medical devices or medical devices with a same or similar classification in a foreign jurisdiction or any devices intended for implantation in the human body. Should Buyer purchase or use **onsemi** products for any such unintended or unauthorized application, Buyer shall indemnify and hold **onsemi** and its officers, employees, subsidiaries, affiliates, and distributors harmless against all claims, costs, damages, and expenses, and reasonable attorney fees arising out of, directly or indirectly, any claim of personal injury or death associated with such unintended or unauthorized use, even if such claim alleges that **onsemi** was negligent regarding the design or manufacture of the part. **onsemi** is an Equal Opportunity/Affirmative Action Employer. This literature is subject to all applicable copyright laws and is not for resale in any manner.

ADDITIONAL INFORMATION

TECHNICAL PUBLICATIONS:

Technical Library: www.onsemi.com/design/resources/technical-documentation
onsemi Website: www.onsemi.com

ONLINE SUPPORT: www.onsemi.com/support

For additional information, please contact your local Sales Representative at www.onsemi.com/support/sales