

L4949, NCV4949

100 mA, 5.0 V, Low Dropout Voltage Regulator with Reset and Sense

The L4949 is a monolithic integrated 5.0 V voltage regulator with a very low dropout and additional functions such as reset and an uncommitted voltage sense comparator.

It is designed for supplying microcontroller/microprocessor controlled systems particularly in automotive applications.

Features

- Operating DC Supply Voltage Range 5.0 V to 28 V
- Transient Supply Voltage Up to 40 V
- Extremely Low Quiescent Current in Standby Mode
- High Precision Output Voltage 5.0 V \pm 1%
- Output Current Capability Up to 100 mA
- Very Low Dropout Voltage Less Than 0.4 V
- Reset Circuit Sensing The Output Voltage
- Programmable Reset Pulse Delay
- Voltage Sense Comparator
- Thermal Shutdown and Short Circuit Protections
- NCV Prefix for Automotive and Other Applications Requiring Site and Change Control
- These are Pb-Free Devices

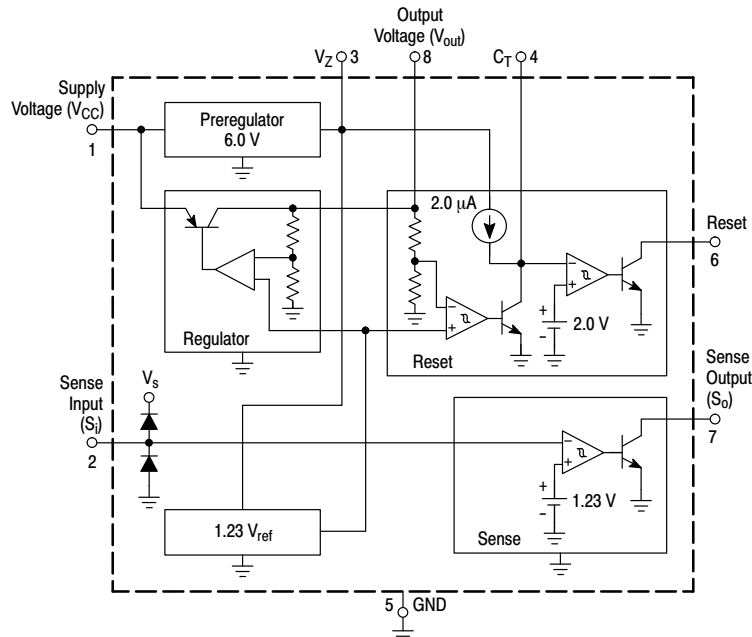

Figure 1. Representative Block Diagram



ON Semiconductor®

<http://onsemi.com>

MARKING DIAGRAMS

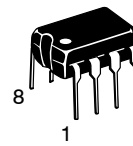

PDIP-8
N SUFFIX
CASE 626

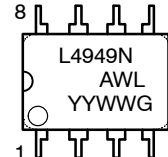

SOIC-8
D SUFFIX
CASE 751

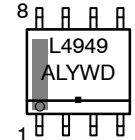

SOIC-8 EP
PD SUFFIX
CASE 751AC

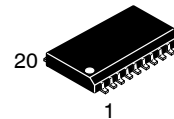
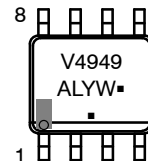

SOIC-20W
DW SUFFIX
CASE 751D

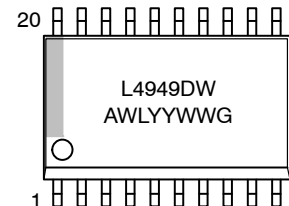

A = Assembly Location
WL, L = Wafer Lot
YY, Y = Year
WW, W = Work Week
G or ■ = Pb-Free Device

PIN CONNECTIONS

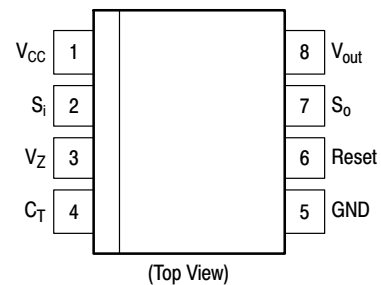

ORDERING INFORMATION

See detailed ordering and shipping information in the package dimensions section on page 9 of this data sheet.

L4949, NCV4949

ABSOLUTE MAXIMUM RATINGS

Rating	Symbol	Value	Unit
DC Operating Supply Voltage	V_{CC}	28	V
Transient Supply Voltage ($t < 1.0$ s)	$V_{CC\ TR}$	40	V
Output Current	I_{out}	Internally Limited	–
Output Voltage	V_{out}	20	V
Sense Input Current	I_{SI}	± 1.0	mA
Sense Input Voltage	V_{SI}	V_{CC}	–
Output Voltages Reset Output Sense Output	V_{Reset} V_{SO}	20 20	V
Output Currents Reset Output Sense Output	I_{Reset} I_{SO}	5.0 5.0	mA
Preregulator Output Voltage	V_Z	7.0	V
Preregulator Output Current	I_Z	5.0	mA
ESD Protection at any pin Human Body Model Machine Model	– –	2000 400	V
Thermal Resistance, Junction–to–Air P Suffix, DIP–8 Plastic Package, Case 626 D Suffix, SOIC–8 Plastic Package, Case 751 PD Suffix, SOIC–8 EP Plastic Package, Case 751AC (Note 1) D Suffix, SOIC–20 Plastic Package, Case 751D	$R_{\theta JA}$	100 200 85 80	$^{\circ}C/W$
Operating Junction Temperature Range	T_J	–40 to +150	$^{\circ}C$
Storage Temperature Range	T_{stg}	–65 to +150	$^{\circ}C$

Stresses exceeding Maximum Ratings may damage the device. Maximum Ratings are stress ratings only. Functional operation above the Recommended Operating Conditions is not implied. Extended exposure to stresses above the Recommended Operating Conditions may affect device reliability.

- Soldered to a 200 mm² 1 oz. copper-clad FR–4 board.

ELECTRICAL CHARACTERISTICS ($V_{CC} = 14$ V, $-40^{\circ}C < T_A < 125^{\circ}C$, unless otherwise specified.)

Characteristic	Symbol	Min	Typ	Max	Unit
Output Voltage ($T_A = 25^{\circ}C$, $I_{out} = 1.0$ mA)	V_{out}	4.95	5.0	5.05	V
Output Voltage (6.0 V $< V_{CC} < 28$ V, 1.0 mA $< I_{out} < 50$ mA)	V_{out}	4.9	5.0	5.1	V
Output Voltage ($V_{CC} = 35$ V, $t < 1.0$ s, 1.0 mA $< I_{out} < 50$ mA)	V_{out}	4.9	5.0	5.1	V
Dropout Voltage $I_{out} = 10$ mA $I_{out} = 50$ mA $I_{out} = 100$ mA	V_{drop}	– – –	0.1 0.2 0.3	0.25 0.40 0.50	V
Input to Output Voltage Difference in Undervoltage Condition ($V_{CC} = 4.0$ V, $I_{out} = 35$ mA)	V_{IO}	–	0.2	0.4	V
Line Regulation (6.0 V $< V_{CC} < 28$ V, $I_{out} = 1.0$ mA)	Reg_{line}	–	1.0	20	mV
Load Regulation (1.0 mA $< I_{out} < 100$ mA)	Reg_{load}	–	8.0	30	mV
Current Limit $V_{out} = 4.5$ V $V_{out} = 0$ V	I_{Lim}	105 –	200 100	400 –	mA
Quiescent Current ($I_{out} = 0.3$ mA, $T_A < 100^{\circ}C$)	I_{QSE}	–	150	260	μA
Quiescent Current ($I_{out} = 100$ mA)	I_Q	–	–	5.0	mA

L4949, NCV4949

ELECTRICAL CHARACTERISTICS (continued) ($V_{CC} = 14\text{ V}$, $-40^{\circ}\text{C} < T_A < 125^{\circ}\text{C}$, unless otherwise specified.)

Characteristic	Symbol	Min	Typ	Max	Unit
RESET					
Reset Threshold Voltage	V_{Resth}	-	$V_{\text{out}} - 0.5$	-	V
Reset Threshold Hysteresis @ $T_A = 25^{\circ}\text{C}$ @ $T_A = -40$ to $+125^{\circ}\text{C}$	$V_{\text{Resth,hys}}$	50 50	100 -	200 300	mV
Reset Pulse Delay ($C_T = 100\text{ nF}$, $t_R \geq 100\text{ }\mu\text{s}$)	t_{ResD}	55	100	180	ms
Reset Reaction Time ($C_T = 100\text{ nF}$)	t_{ResR}	-	5.0	30	μs
Reset Output Low Voltage ($R_{\text{Reset}} = 10\text{ k}\Omega$ to V_{out} , $V_{CC} \geq 3.0\text{ V}$)	V_{ResL}	-	-	0.4	V
Reset Output High Leakage Current ($V_{\text{Reset}} = 5.0\text{ V}$)	I_{ResH}	-	-	1.0	μA
Delay Comparator Threshold	V_{CTth}	-	2.0	-	V
Delay Comparator Threshold Hysteresis	$V_{\text{CTth,hys}}$	-	100	-	mV
SENSE					
Sense Low Threshold (V_{SI} Decreasing = 1.5 V to 1.0 V)	V_{SOth}	1.16	1.23	1.35	V
Sense Threshold Hysteresis	$V_{\text{SOth,hys}}$	20	100	200	mV
Sense Output Low Voltage ($V_{\text{SI}} \leq 1.16\text{ V}$, $V_{CC} \geq 3.0\text{ V}$, $R_{\text{SO}} = 10\text{ k}\Omega$ to V_{out})	V_{SOL}	-	-	0.4	V
Sense Output Leakage ($V_{\text{SO}} = 5.0\text{ V}$, $V_{\text{SI}} \geq 1.5\text{ V}$)	I_{SOH}	-	-	1.0	μA
Sense Input Current	I_{SI}	-1.0	0.1	1.0	μA
PREREGULATOR					
Preregulator Output Voltage ($I_Z = 10\text{ }\mu\text{A}$)	V_Z	-	6.3	-	V

PIN FUNCTION DESCRIPTION

Pin SOIC-8, PDIP-8	Pin SOIC-8 EP	Pin SOIC-20W	Symbol	Description
1	1	19	V_{CC}	Supply Voltage
2	2	20	S_i	Input of Sense Comparator
3	3	1	V_Z	Output of Preregulator
4	4	2	C_T	Reset Delay Capacitor
5	5	4 - 7, 14 - 17	GND	Ground
6	6	10	Reset	Output of Reset Comparator
7	7	11	S_o	Output of Sense Comparator
8	8	12	V_{out}	Main Regulator Output
-	-	3, 8, 9, 13, 18	NC	No Connect
-	EPAD	-	EPAD	Connect to Ground potential or leave unconnected

TYPICAL CHARACTERIZATION CURVES

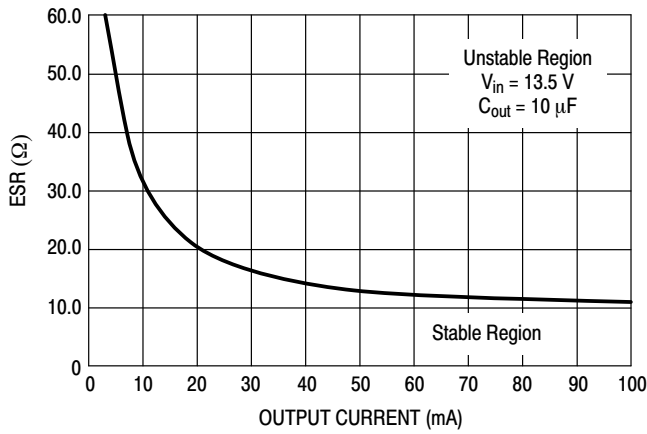

Figure 2. ESR Stability Border Vs. Output Current (Full ESR Range)

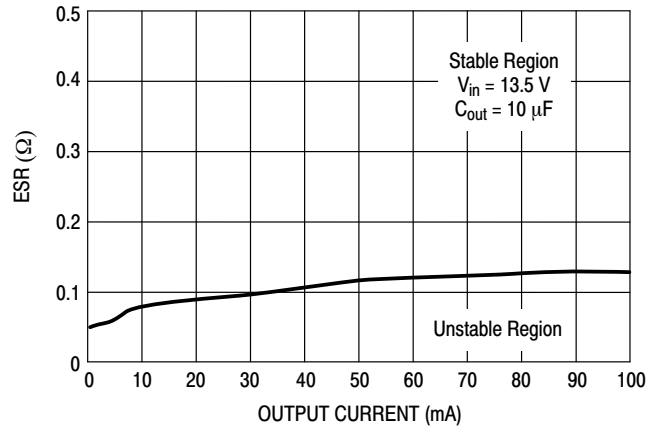

Figure 3. ESR Stability Border Vs. Output Current (Very Low ESR)

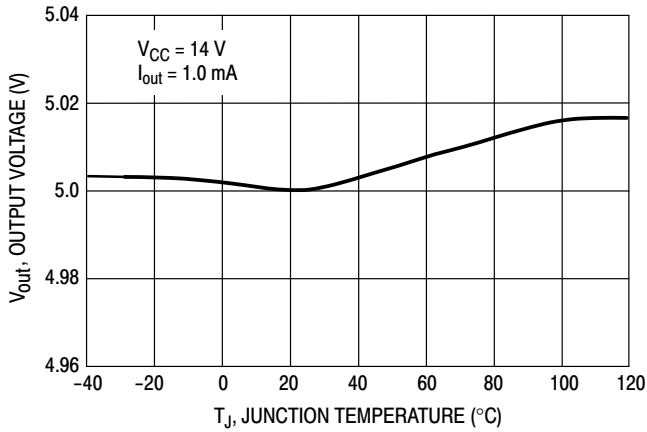

Figure 4. Output Voltage versus Junction Temperature

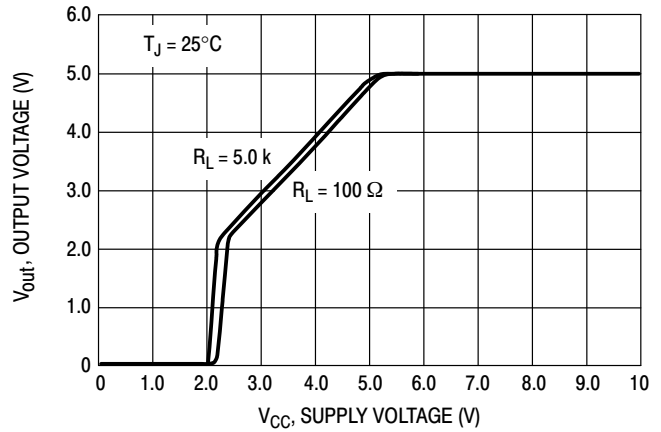

Figure 5. Output Voltage versus Supply Voltage

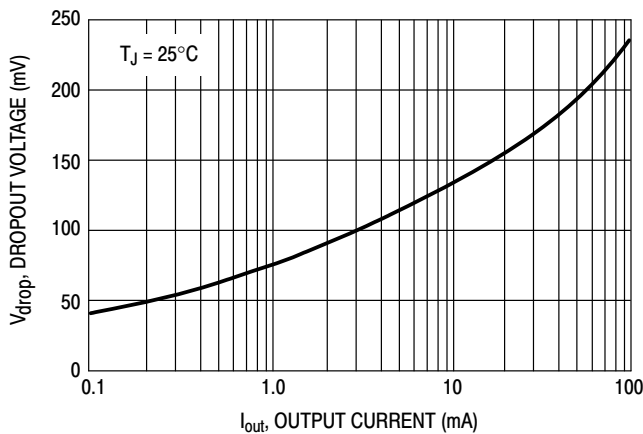

Figure 6. Dropout Voltage versus Output Current

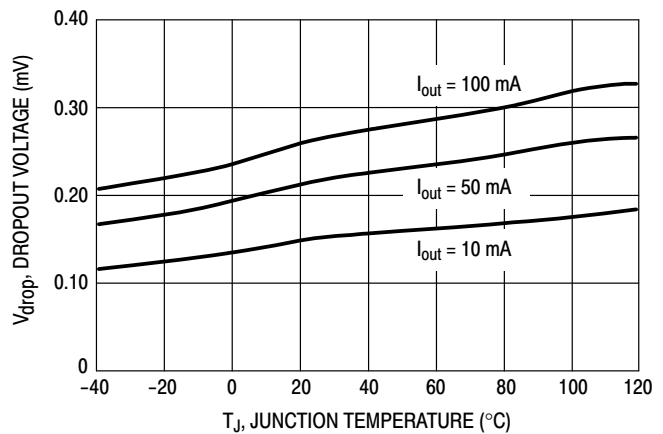

Figure 7. Dropout Voltage versus Junction Temperature

TYPICAL CHARACTERIZATION CURVES (continued)

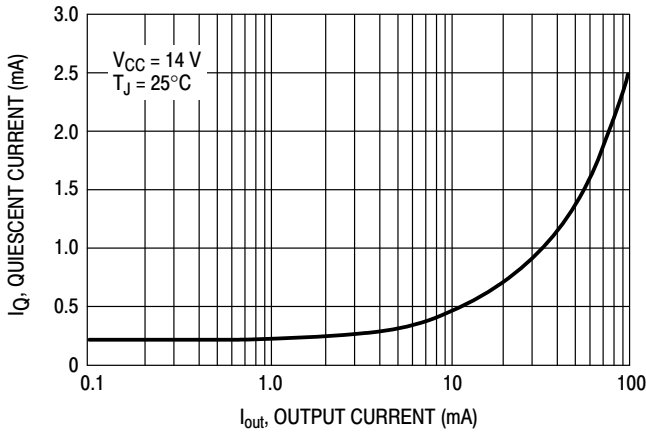

Figure 8. Quiescent Current versus Output Current

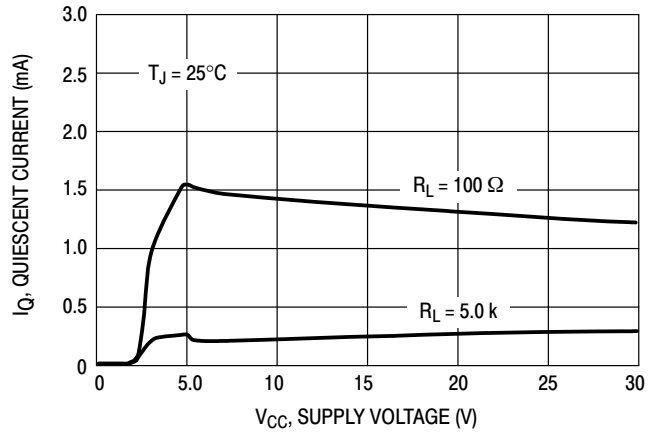

Figure 9. Quiescent Current versus Supply Voltage

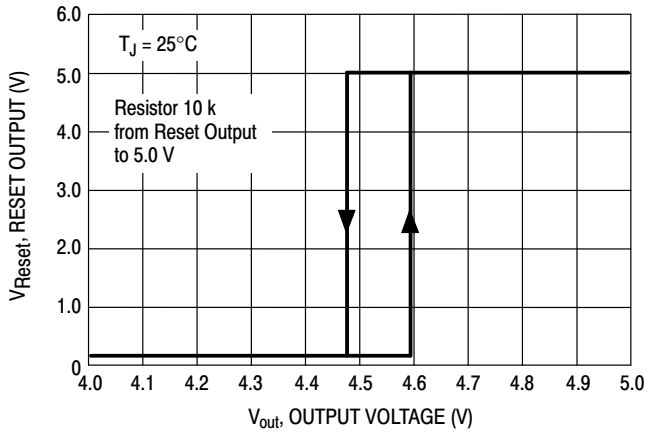

Figure 10. Reset Output versus Regulator Output Voltage

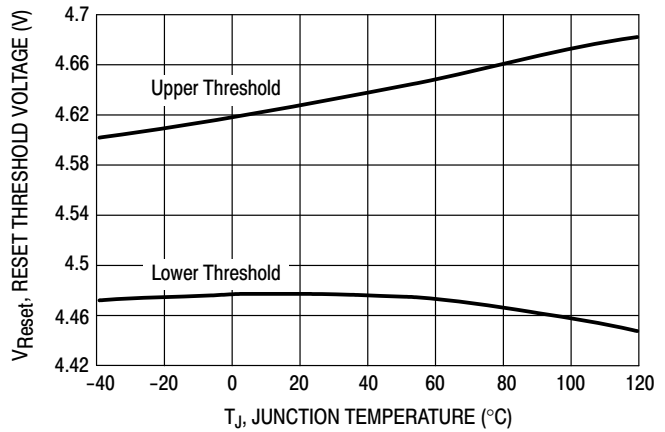

Figure 11. Reset Thresholds versus Junction Temperature

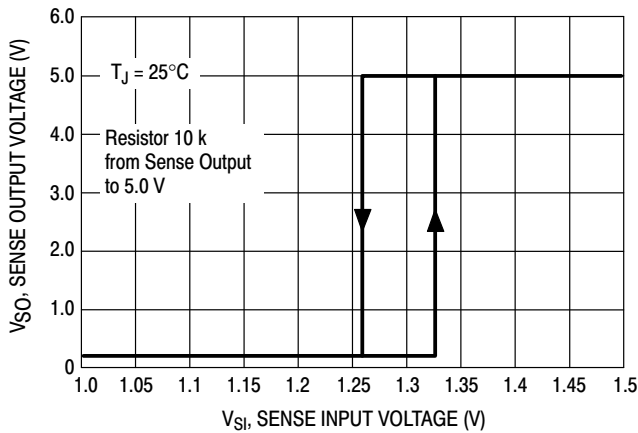

Figure 12. Sense Output versus Sense Input Voltage

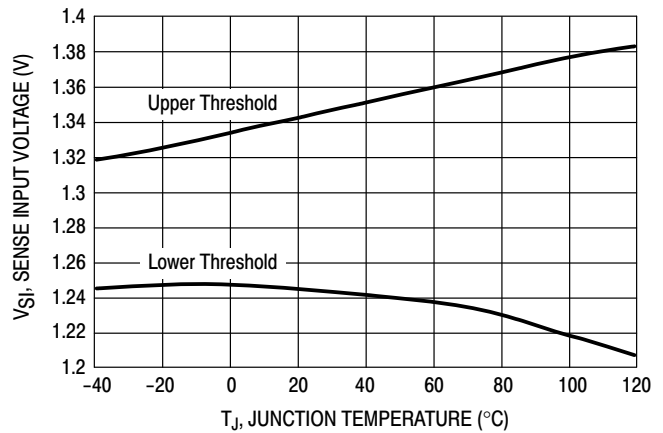

Figure 13. Sense Thresholds versus Junction Temperature

APPLICATION INFORMATION

Supply Voltage Transient

High supply voltage transients can cause a reset output signal perturbation. For supply voltages greater than 8.0 V the circuit shows a high immunity of the reset output against supply transients of more than 100 V/ μ s. For supply voltages

less than 8.0 V supply transients of more than 0.4 V/ μ s can cause a reset signal perturbation. To improve the transient behavior for supply voltages less than 8.0 V a capacitor at Pin 3 can be used. A capacitor at Pin 3 ($C_3 \leq 1.0 \mu$ F) also reduces the output noise.

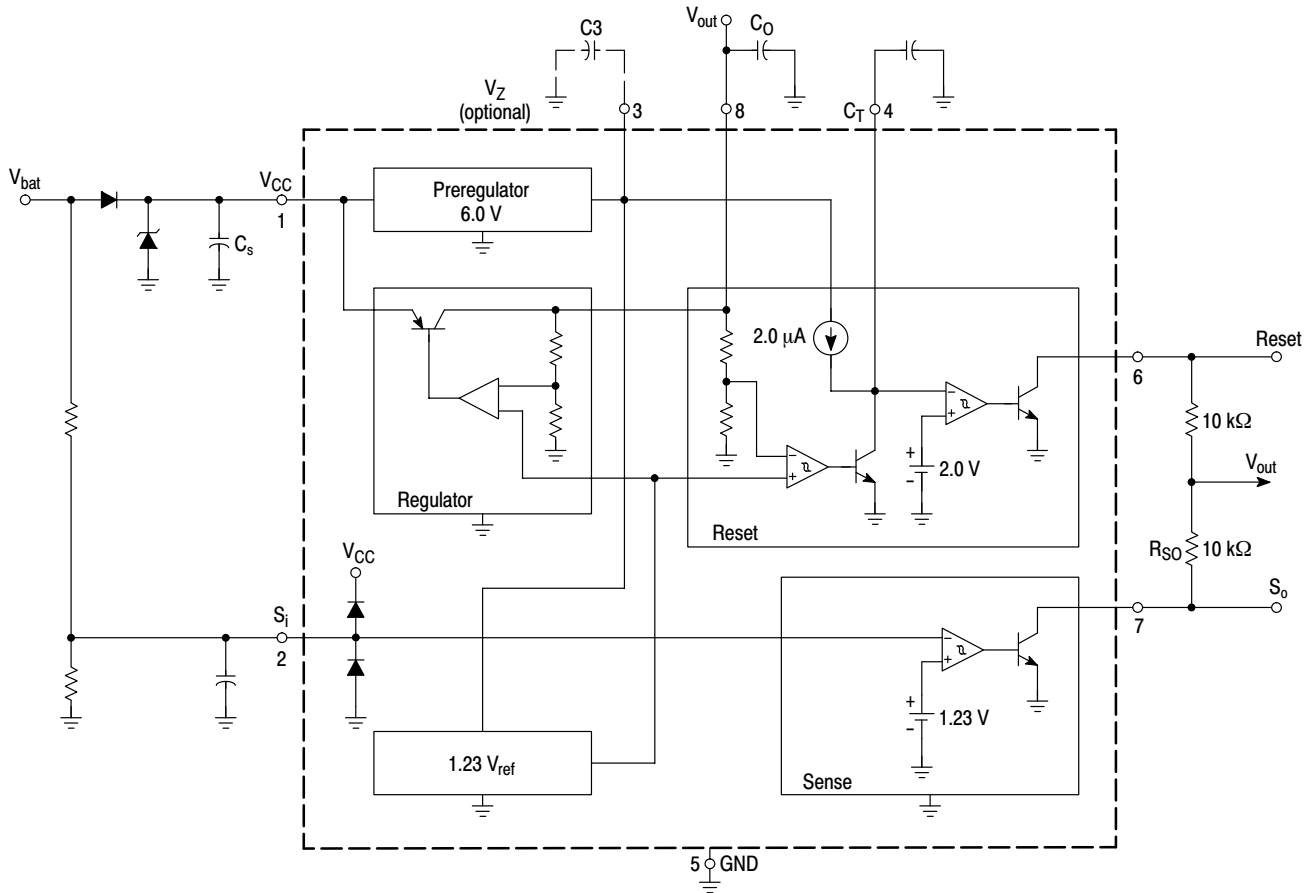

- NOTE: 1. For stability: $C_s \geq 1.0 \mu$ F, $C_o \geq 4.7 \mu$ F, $ESR < 10 \Omega$ at 10 kHz
 2. Recommended for application: $C_s = C_o = 10 \mu$ F

Figure 14. Application Schematic

OPERATING DESCRIPTION

The L4949 is a monolithic integrated low dropout voltage regulator. Several outstanding features and auxiliary functions are implemented to meet the requirements of supplying microprocessor systems in automotive applications. It is also suitable in other applications where the included functions are required. The modular approach of this device allows the use of other features and functions independently when required.

Voltage Regulator

The voltage regulator uses an isolated collector vertical PNP transistor as a regulating element. With this structure, very low dropout voltage at currents up to 100 mA is obtained. The dropout operation of the standby regulator is maintained down to 3.0 V input supply voltage. The output voltage is regulated up to a transient input supply voltage of 35 V.

A typical curve showing the standby output voltage as a function of the input supply voltage is shown in Figure 16.

The current consumption of the device (quiescent current) is less than 200 μ A.

To reduce the quiescent current peak in the undervoltage region and to improve the transient response in this region, the dropout voltage is controlled. The quiescent current as a function of the supply input voltage is shown in Figure 17.

Short Circuit Protection:

The maximum output current is internally limited. In case of short circuit, the output current is foldback current limited as described in Figure 15.

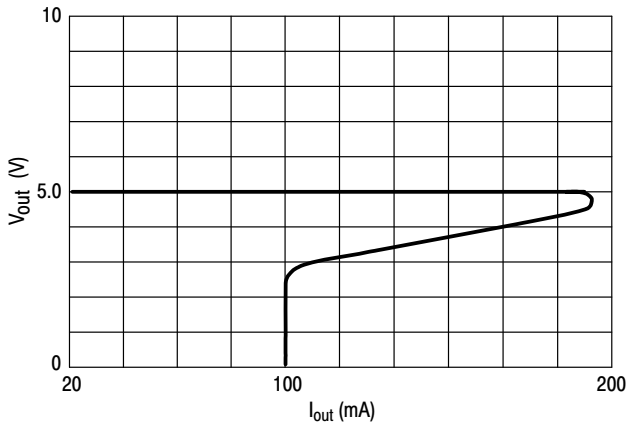

Figure 15. Foldback Characteristic of V_{out}

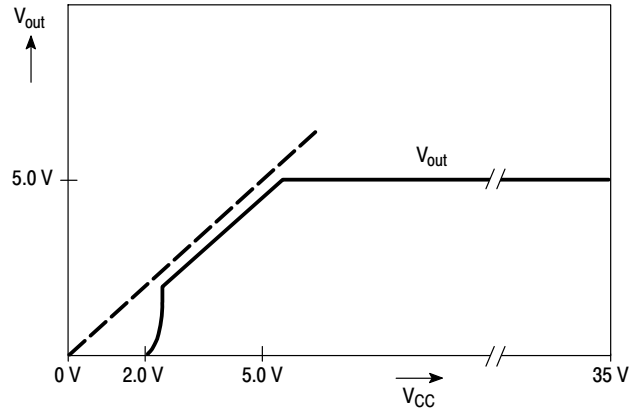

Figure 16. Output Voltage versus Supply Voltage

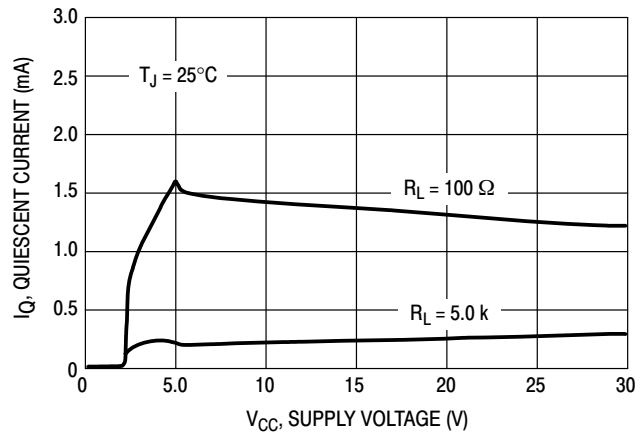

Figure 17. Quiescent Current versus Supply Voltage

Preregulator

To improve transient immunity a preregulator stabilizes the internal supply voltage to 6.0 V. This internal voltage is present at Pin 3 (V_Z). This voltage should not be used as an output because the output capability is very small ($\leq 100 \mu$ A).

This output may be used to improve transient behavior for supply voltages less than 8.0 V. In this case a capacitor (100 nF – 1.0 μ F) must be connected between Pin 3 and GND. If this feature is not used Pin 3 must be left open.

Reset Circuit

The block circuit diagram of the reset circuit is shown in Figure 18.

The reset circuit supervises the output voltage. The reset threshold of 4.5 V is defined by the internal reference voltage and standby output divider.

The reset pulse delay time t_{RD} , is defined by the charge time of an external capacitor C_T :

$$t_{RD} = \frac{C_T \times 2.0 \text{ V}}{2.0 \mu\text{A}}$$

The reaction time of the reset circuit originates from the discharge time limitation of the reset capacitor C_T and is proportional to the value of C_T . The reaction time of the reset circuit increases the noise immunity.

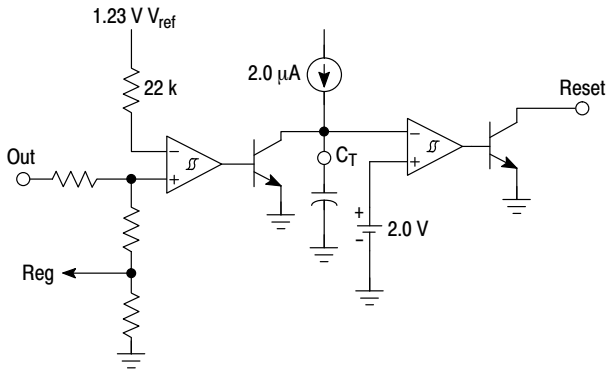

Figure 18. Reset Circuit

Output voltage drops below the reset threshold only marginally longer than the reaction time results in a shorter reset delay time.

The nominal reset delay time will be generated for output voltage drops longer than approximately 50 μs. The typical reset output waveforms are shown in Figure 19.

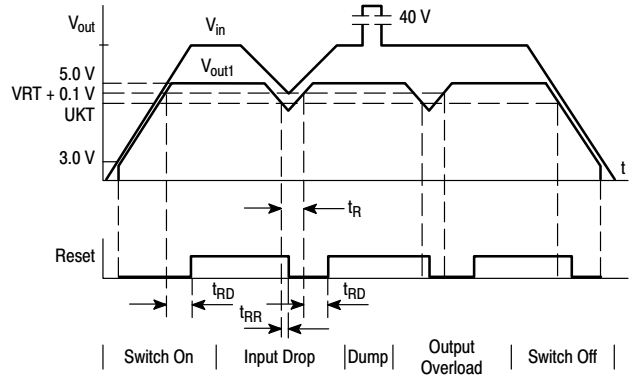

Figure 19. Typical Reset Output Waveforms

Sense Comparator

The sense comparator compares an input signal with an internal voltage reference of typical 1.23 V. The use of an external voltage divider makes this comparator very flexible in the application.

It can be used to supervise the input voltage either before or after a protection diode and to provide additional information to the microprocessor such as low voltage warnings.

L4949, NCV4949

ORDERING INFORMATION

Device	Operating Temperature Range	Package	Shipping [†]
L4949NG	T _J = -40°C to +125°C	PDIP-8 (Pb-Free)	50 Units / Rail
L4949DG		SOIC-8 (Pb-Free)	98 Units / Rail
L4949DR2G		SOIC-8 (Pb-Free)	2500 Units / Tape & Reel
NCV4949DG*		SOIC-8 (Pb-Free)	98 Units / Rail
NCV4949PDG*		SOIC-8 EP (Pb-Free)	98 Units / Rail
NCV4949DR2G*		SOIC-8 (Pb-Free)	2500 Units / Tape & Reel
NCV4949PDR2G*		SOIC-8 EP (Pb-Free)	2500 Units / Tape & Reel
NCV4949DWR2G*		SOIC-20W (Pb-Free)	1000 Units / Tape & Reel

[†]For information on tape and reel specifications, including part orientation and tape sizes, please refer to our Tape and Reel Packaging Specifications Brochure, BRD8011/D.

*NCV4949: T_{low} = -40°C, T_{high} = +125°C. Guaranteed by design.

NCV prefix is for automotive and other applications requiring site and change control.

MECHANICAL CASE OUTLINE

PACKAGE DIMENSIONS

ON Semiconductor®

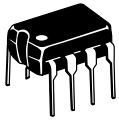

SCALE 1:1

PDIP-8
CASE 626-05
ISSUE P

DATE 22 APR 2015

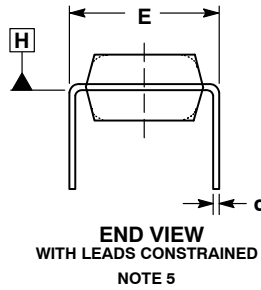
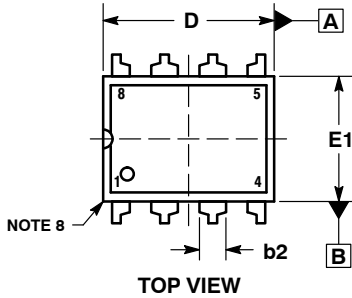

NOTES:

1. DIMENSIONING AND TOLERANCING PER ASME Y14.5M, 1994.
2. CONTROLLING DIMENSION: INCHES.
3. DIMENSIONS A, A1 AND L ARE MEASURED WITH THE PACKAGE SEATED IN JEDEC SEATING PLANE GAUGE GS-3.
4. DIMENSIONS D, D1 AND E1 DO NOT INCLUDE MOLD FLASH OR PROTRUSIONS. MOLD FLASH OR PROTRUSIONS ARE NOT TO EXCEED 0.10 INCH.
5. DIMENSION E IS MEASURED AT A POINT 0.015 BELOW DATUM PLANE H WITH THE LEADS CONSTRAINED PERPENDICULAR TO DATUM C.
6. DIMENSION eB IS MEASURED AT THE LEAD TIPS WITH THE LEADS UNCONSTRAINED.
7. DATUM PLANE H IS COINCIDENT WITH THE BOTTOM OF THE LEADS, WHERE THE LEADS EXIT THE BODY.
8. PACKAGE CONTOUR IS OPTIONAL (ROUNDED OR SQUARE CORNERS).

DIM	INCHES		MILLIMETERS	
	MIN	MAX	MIN	MAX
A	----	0.210	----	5.33
A1	0.015	----	0.38	----
A2	0.115	0.195	2.92	4.95
b	0.014	0.022	0.35	0.56
b2	0.060 TYP		1.52 TYP	
C	0.008	0.014	0.20	0.36
D	0.355	0.400	9.02	10.16
D1	0.005	----	0.13	----
E	0.300	0.325	7.62	8.26
E1	0.240	0.280	6.10	7.11
e	0.100 BSC		2.54 BSC	
eB	----	0.430	----	10.92
L	0.115	0.150	2.92	3.81
M	----	10°	----	10°

GENERIC MARKING DIAGRAM*



- XXXX = Specific Device Code
- A = Assembly Location
- WL = Wafer Lot
- YY = Year
- WW = Work Week
- G = Pb-Free Package

*This information is generic. Please refer to device data sheet for actual part marking. Pb-Free indicator, "G" or microdot "▪", may or may not be present.

- STYLE 1:
PIN 1. AC IN
2. DC + IN
3. DC - IN
4. AC IN
5. GROUND
6. OUTPUT
7. AUXILIARY
8. V_{CC}

DOCUMENT NUMBER:	98ASB42420B	Electronic versions are uncontrolled except when accessed directly from the Document Repository. Printed versions are uncontrolled except when stamped "CONTROLLED COPY" in red.
DESCRIPTION:	PDIP-8	PAGE 1 OF 1

ON Semiconductor and are trademarks of Semiconductor Components Industries, LLC dba ON Semiconductor or its subsidiaries in the United States and/or other countries. ON Semiconductor reserves the right to make changes without further notice to any products herein. ON Semiconductor makes no warranty, representation or guarantee regarding the suitability of its products for any particular purpose, nor does ON Semiconductor assume any liability arising out of the application or use of any product or circuit, and specifically disclaims any and all liability, including without limitation special, consequential or incidental damages. ON Semiconductor does not convey any license under its patent rights nor the rights of others.

MECHANICAL CASE OUTLINE PACKAGE DIMENSIONS



SCALE 1:1

SOIC-8 NB
CASE 751-07
ISSUE AK

DATE 16 FEB 2011



- NOTES:
1. DIMENSIONING AND TOLERANCING PER ANSI Y14.5M, 1982.
 2. CONTROLLING DIMENSION: MILLIMETER.
 3. DIMENSION A AND B DO NOT INCLUDE MOLD PROTRUSION.
 4. MAXIMUM MOLD PROTRUSION 0.15 (0.006) PER SIDE.
 5. DIMENSION D DOES NOT INCLUDE DAMBAR PROTRUSION. ALLOWABLE DAMBAR PROTRUSION SHALL BE 0.127 (0.005) TOTAL IN EXCESS OF THE D DIMENSION AT MAXIMUM MATERIAL CONDITION.
 6. 751-01 THRU 751-06 ARE OBSOLETE. NEW STANDARD IS 751-07.

DIM	MILLIMETERS		INCHES	
	MIN	MAX	MIN	MAX
A	4.80	5.00	0.189	0.197
B	3.80	4.00	0.150	0.157
C	1.35	1.75	0.053	0.069
D	0.33	0.51	0.013	0.020
G	1.27 BSC		0.050 BSC	
H	0.10	0.25	0.004	0.010
J	0.19	0.25	0.007	0.010
K	0.40	1.27	0.016	0.050
M	0°	8°	0°	8°
N	0.25	0.50	0.010	0.020
S	5.80	6.20	0.228	0.244

GENERIC MARKING DIAGRAM*

SOLDERING FOOTPRINT*

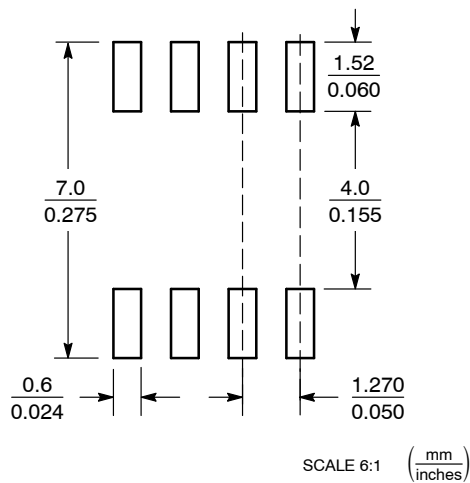

XXXXXX = Specific Device Code
 A = Assembly Location
 L = Wafer Lot
 Y = Year
 W = Work Week
 ■ = Pb-Free Package

XXXXXX = Specific Device Code
 A = Assembly Location
 Y = Year
 WW = Work Week
 ■ = Pb-Free Package

*This information is generic. Please refer to device data sheet for actual part marking. Pb-Free indicator, "G" or microdot "•", may or may not be present. Some products may not follow the Generic Marking.

*For additional information on our Pb-Free strategy and soldering details, please download the ON Semiconductor Soldering and Mounting Techniques Reference Manual, SOLDERRM/D.

STYLES ON PAGE 2

DOCUMENT NUMBER:	98ASB42564B	Electronic versions are uncontrolled except when accessed directly from the Document Repository. Printed versions are uncontrolled except when stamped "CONTROLLED COPY" in red.
DESCRIPTION:	SOIC-8 NB	PAGE 1 OF 2

onsemi and ONsemi are trademarks of Semiconductor Components Industries, LLC dba onsemi or its subsidiaries in the United States and/or other countries. onsemi reserves the right to make changes without further notice to any products herein. onsemi makes no warranty, representation or guarantee regarding the suitability of its products for any particular purpose, nor does onsemi assume any liability arising out of the application or use of any product or circuit, and specifically disclaims any and all liability, including without limitation special, consequential or incidental damages. onsemi does not convey any license under its patent rights nor the rights of others.

SOIC-8 NB
CASE 751-07
ISSUE AK

DATE 16 FEB 2011

- | | | | |
|---|--|--|--|
| <p>STYLE 1:
 PIN 1. EMITTER
 2. COLLECTOR
 3. COLLECTOR
 4. EMITTER
 5. EMITTER
 6. BASE
 7. BASE
 8. EMITTER</p> | <p>STYLE 2:
 PIN 1. COLLECTOR, DIE, #1
 2. COLLECTOR, #1
 3. COLLECTOR, #2
 4. COLLECTOR, #2
 5. BASE, #2
 6. EMITTER, #2
 7. BASE, #1
 8. EMITTER, #1</p> | <p>STYLE 3:
 PIN 1. DRAIN, DIE #1
 2. DRAIN, #1
 3. DRAIN, #2
 4. DRAIN, #2
 5. GATE, #2
 6. SOURCE, #2
 7. GATE, #1
 8. SOURCE, #1</p> | <p>STYLE 4:
 PIN 1. ANODE
 2. ANODE
 3. ANODE
 4. ANODE
 5. ANODE
 6. ANODE
 7. ANODE
 8. COMMON CATHODE</p> |
| <p>STYLE 5:
 PIN 1. DRAIN
 2. DRAIN
 3. DRAIN
 4. DRAIN
 5. GATE
 6. GATE
 7. SOURCE
 8. SOURCE</p> | <p>STYLE 6:
 PIN 1. SOURCE
 2. DRAIN
 3. DRAIN
 4. SOURCE
 5. SOURCE
 6. GATE
 7. GATE
 8. SOURCE</p> | <p>STYLE 7:
 PIN 1. INPUT
 2. EXTERNAL BYPASS
 3. THIRD STAGE SOURCE
 4. GROUND
 5. DRAIN
 6. GATE 3
 7. SECOND STAGE Vd
 8. FIRST STAGE Vd</p> | <p>STYLE 8:
 PIN 1. COLLECTOR, DIE #1
 2. BASE, #1
 3. BASE, #2
 4. COLLECTOR, #2
 5. COLLECTOR, #2
 6. EMITTER, #2
 7. EMITTER, #1
 8. COLLECTOR, #1</p> |
| <p>STYLE 9:
 PIN 1. EMITTER, COMMON
 2. COLLECTOR, DIE #1
 3. COLLECTOR, DIE #2
 4. EMITTER, COMMON
 5. EMITTER, COMMON
 6. BASE, DIE #2
 7. BASE, DIE #1
 8. EMITTER, COMMON</p> | <p>STYLE 10:
 PIN 1. GROUND
 2. BIAS 1
 3. OUTPUT
 4. GROUND
 5. GROUND
 6. BIAS 2
 7. INPUT
 8. GROUND</p> | <p>STYLE 11:
 PIN 1. SOURCE 1
 2. GATE 1
 3. SOURCE 2
 4. GATE 2
 5. DRAIN 2
 6. DRAIN 2
 7. DRAIN 1
 8. DRAIN 1</p> | <p>STYLE 12:
 PIN 1. SOURCE
 2. SOURCE
 3. SOURCE
 4. GATE
 5. DRAIN
 6. DRAIN
 7. DRAIN
 8. DRAIN</p> |
| <p>STYLE 13:
 PIN 1. N.C.
 2. SOURCE
 3. SOURCE
 4. GATE
 5. DRAIN
 6. DRAIN
 7. DRAIN
 8. DRAIN</p> | <p>STYLE 14:
 PIN 1. N-SOURCE
 2. N-GATE
 3. P-SOURCE
 4. P-GATE
 5. P-DRAIN
 6. P-DRAIN
 7. N-DRAIN
 8. N-DRAIN</p> | <p>STYLE 15:
 PIN 1. ANODE 1
 2. ANODE 1
 3. ANODE 1
 4. ANODE 1
 5. CATHODE, COMMON
 6. CATHODE, COMMON
 7. CATHODE, COMMON
 8. CATHODE, COMMON</p> | <p>STYLE 16:
 PIN 1. EMITTER, DIE #1
 2. BASE, DIE #1
 3. EMITTER, DIE #2
 4. BASE, DIE #2
 5. COLLECTOR, DIE #2
 6. COLLECTOR, DIE #2
 7. COLLECTOR, DIE #1
 8. COLLECTOR, DIE #1</p> |
| <p>STYLE 17:
 PIN 1. VCC
 2. V2OUT
 3. V1OUT
 4. TXE
 5. RXE
 6. VEE
 7. GND
 8. ACC</p> | <p>STYLE 18:
 PIN 1. ANODE
 2. ANODE
 3. SOURCE
 4. GATE
 5. DRAIN
 6. DRAIN
 7. CATHODE
 8. CATHODE</p> | <p>STYLE 19:
 PIN 1. SOURCE 1
 2. GATE 1
 3. SOURCE 2
 4. GATE 2
 5. DRAIN 2
 6. MIRROR 2
 7. DRAIN 1
 8. MIRROR 1</p> | <p>STYLE 20:
 PIN 1. SOURCE (N)
 2. GATE (N)
 3. SOURCE (P)
 4. GATE (P)
 5. DRAIN
 6. DRAIN
 7. DRAIN
 8. DRAIN</p> |
| <p>STYLE 21:
 PIN 1. CATHODE 1
 2. CATHODE 2
 3. CATHODE 3
 4. CATHODE 4
 5. CATHODE 5
 6. COMMON ANODE
 7. COMMON ANODE
 8. CATHODE 6</p> | <p>STYLE 22:
 PIN 1. I/O LINE 1
 2. COMMON CATHODE/VCC
 3. COMMON CATHODE/VCC
 4. I/O LINE 3
 5. COMMON ANODE/GND
 6. I/O LINE 4
 7. I/O LINE 5
 8. COMMON ANODE/GND</p> | <p>STYLE 23:
 PIN 1. LINE 1 IN
 2. COMMON ANODE/GND
 3. COMMON ANODE/GND
 4. LINE 2 IN
 5. LINE 2 OUT
 6. COMMON ANODE/GND
 7. COMMON ANODE/GND
 8. LINE 1 OUT</p> | <p>STYLE 24:
 PIN 1. BASE
 2. EMITTER
 3. COLLECTOR/ANODE
 4. COLLECTOR/ANODE
 5. CATHODE
 6. CATHODE
 7. COLLECTOR/ANODE
 8. COLLECTOR/ANODE</p> |
| <p>STYLE 25:
 PIN 1. VIN
 2. N/C
 3. REXT
 4. GND
 5. IOUT
 6. IOUT
 7. IOUT
 8. IOUT</p> | <p>STYLE 26:
 PIN 1. GND
 2. dv/dt
 3. ENABLE
 4. ILIMIT
 5. SOURCE
 6. SOURCE
 7. SOURCE
 8. VCC</p> | <p>STYLE 27:
 PIN 1. ILIMIT
 2. OVLO
 3. UVLO
 4. INPUT+
 5. SOURCE
 6. SOURCE
 7. SOURCE
 8. DRAIN</p> | <p>STYLE 28:
 PIN 1. SW_TO_GND
 2. DASIC_OFF
 3. DASIC_SW_DET
 4. GND
 5. V_MON
 6. VBULK
 7. VBULK
 8. VIN</p> |
| <p>STYLE 29:
 PIN 1. BASE, DIE #1
 2. EMITTER, #1
 3. BASE, #2
 4. EMITTER, #2
 5. COLLECTOR, #2
 6. COLLECTOR, #2
 7. COLLECTOR, #1
 8. COLLECTOR, #1</p> | <p>STYLE 30:
 PIN 1. DRAIN 1
 2. DRAIN 1
 3. GATE 2
 4. SOURCE 2
 5. SOURCE 1/DRAIN 2
 6. SOURCE 1/DRAIN 2
 7. SOURCE 1/DRAIN 2
 8. GATE 1</p> | | |

DOCUMENT NUMBER:	98ASB42564B	Electronic versions are uncontrolled except when accessed directly from the Document Repository. Printed versions are uncontrolled except when stamped "CONTROLLED COPY" in red.
DESCRIPTION:	SOIC-8 NB	PAGE 2 OF 2

onsemi and **ONSEMI** are trademarks of Semiconductor Components Industries, LLC dba **onsemi** or its subsidiaries in the United States and/or other countries. **onsemi** reserves the right to make changes without further notice to any products herein. **onsemi** makes no warranty, representation or guarantee regarding the suitability of its products for any particular purpose, nor does **onsemi** assume any liability arising out of the application or use of any product or circuit, and specifically disclaims any and all liability, including without limitation special, consequential or incidental damages. **onsemi** does not convey any license under its patent rights nor the rights of others.

MECHANICAL CASE OUTLINE PACKAGE DIMENSIONS



SCALE 1:1

SOIC-8 EP CASE 751AC ISSUE E

DATE 05 OCT 2022

NOTES:

- DIMENSIONING AND TOLERANCING PER ASME Y14.5M, 1994.
- CONTROLLING DIMENSION: MILLIMETERS
- DIMENSION b DOES NOT INCLUDE DAMBAR PROTRUSION. ALLOWABLE PROTRUSION SHALL BE 0.004 IN EXCESS OF MAXIMUM MATERIAL CONDITION.
- DIMENSION D DOES NOT INCLUDE MOLD FLASH, PROTRUSIONS, OR GATE BURRS. MOLD FLASH, PROTRUSIONS, OR GATE BURRS SHALL NOT EXCEED 0.006 PER SIDE. DIMENSION E1 DOES NOT INCLUDE INTERLEAD FLASH OR PROTRUSION. INTERLEAD FLASH OR PROTRUSION SHALL NOT EXCEED 0.010 mm PER SIDE.
- THE PACKAGE TOP MAY BE SMALLER THAN THE PACKAGE BOTTOM. DIMENSIONS D AND E1 ARE DETERMINED AT THE OUTERMOST EXTREMES OF THE PLASTIC BODY AT DATUM H.
- DATUMS A AND B ARE TO BE DETERMINED AT DATUM H.
- DIMENSIONS b AND c APPLY TO THE FLAT SECTION OF THE LEAD BETWEEN 0.10 TO 0.25 FROM THE LEAD TIP.
- A1 IS DEFINED AS THE VERTICAL DISTANCE FROM THE SEATING PLANE TO THE LOWEST POINT ON THE PACKAGE BODY.

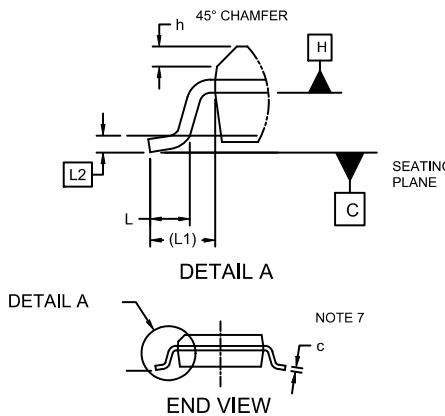
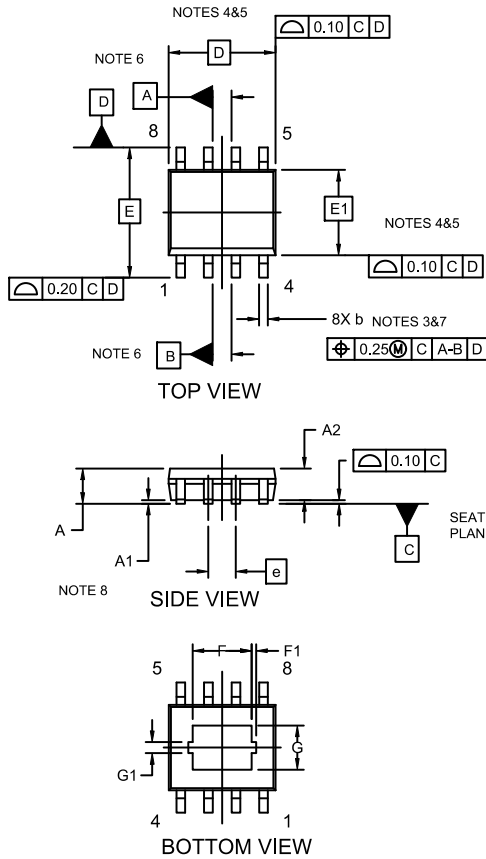

DIM	MILLIMETERS		
	MIN.	NOM.	MAX.
A	1.35	1.55	1.75
A1	---	0.05	0.10
A2	1.35	1.50	1.65
b	0.31	0.41	0.51
c	0.17	0.21	0.23
D	4.90 BSC		
E	6.00 BSC		
E1	3.90 BSC		
e	1.27 BSC		
F	2.24	2.72	3.20
F1	0.20 REF		
G	1.55	2.03	2.51
G1	0.46 REF		
h	0.25	0.38	0.50
L	0.40	0.84	1.27
L1	1.04 REF		
L2	0.25 REF		
∅	0°	4°	8°

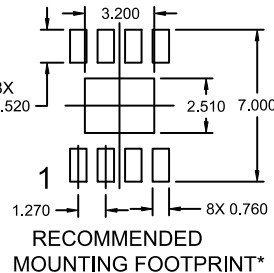

*For additional information on our Pb-Free strategy and soldering details, please download the ON Semiconductor Soldering and Mounting Techniques Reference Manual, SOLDERRM/D."

GENERIC MARKING DIAGRAM*

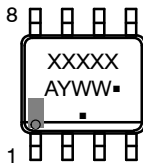

XXXXXX = Specific Device Code
 A = Assembly Location
 Y = Year
 WW = Work Week
 ■ = Pb-Free Package

*This information is generic. Please refer to device data sheet for actual part marking. Pb-Free indicator, "G" or microdot "■", may or may not be present and may be in either location. Some products may not follow the Generic Marking.

DOCUMENT NUMBER:	98AON14029D	Electronic versions are uncontrolled except when accessed directly from the Document Repository. Printed versions are uncontrolled except when stamped "CONTROLLED COPY" in red.
DESCRIPTION:	SOIC-8 EP	PAGE 1 OF 1

onsemi and ONsemi are trademarks of Semiconductor Components Industries, LLC dba onsemi or its subsidiaries in the United States and/or other countries. onsemi reserves the right to make changes without further notice to any products herein. onsemi makes no warranty, representation or guarantee regarding the suitability of its products for any particular purpose, nor does onsemi assume any liability arising out of the application or use of any product or circuit, and specifically disclaims any and all liability, including without limitation special, consequential or incidental damages. onsemi does not convey any license under its patent rights nor the rights of others.

MECHANICAL CASE OUTLINE PACKAGE DIMENSIONS



SCALE 1:1

SOIC-20 WB
CASE 751D-05
ISSUE H

DATE 22 APR 2015



NOTES:

1. DIMENSIONS ARE IN MILLIMETERS.
2. INTERPRET DIMENSIONS AND TOLERANCES PER ASME Y14.5M, 1994.
3. DIMENSIONS D AND E DO NOT INCLUDE MOLD PROTRUSION.
4. MAXIMUM MOLD PROTRUSION 0.15 PER SIDE.
5. DIMENSION B DOES NOT INCLUDE DAMBAR PROTRUSION. ALLOWABLE PROTRUSION SHALL BE 0.13 TOTAL IN EXCESS OF B DIMENSION AT MAXIMUM MATERIAL CONDITION.

DIM	MILLIMETERS	
	MIN	MAX
A	2.35	2.65
A1	0.10	0.25
b	0.35	0.49
c	0.23	0.32
D	12.65	12.95
E	7.40	7.60
e	1.27 BSC	
H	10.05	10.55
h	0.25	0.75
L	0.50	0.90
θ	0°	7°

RECOMMENDED
SOLDERING FOOTPRINT*



DIMENSIONS: MILLIMETERS

*For additional information on our Pb-Free strategy and soldering details, please download the ON Semiconductor Soldering and Mounting Techniques Reference Manual, SOLDERRM/D.

GENERIC
MARKING DIAGRAM*



- XXXXXX = Specific Device Code
- A = Assembly Location
- WL = Wafer Lot
- YY = Year
- WW = Work Week
- G = Pb-Free Package

*This information is generic. Please refer to device data sheet for actual part marking. Pb-Free indicator, "G" or microdot "▪", may or may not be present. Some products may not follow the Generic Marking.

DOCUMENT NUMBER:	98ASB42343B	Electronic versions are uncontrolled except when accessed directly from the Document Repository. Printed versions are uncontrolled except when stamped "CONTROLLED COPY" in red.
DESCRIPTION:	SOIC-20 WB	PAGE 1 OF 1

onsemi and ONSEMI are trademarks of Semiconductor Components Industries, LLC dba onsemi or its subsidiaries in the United States and/or other countries. onsemi reserves the right to make changes without further notice to any products herein. onsemi makes no warranty, representation or guarantee regarding the suitability of its products for any particular purpose, nor does onsemi assume any liability arising out of the application or use of any product or circuit, and specifically disclaims any and all liability, including without limitation special, consequential or incidental damages. onsemi does not convey any license under its patent rights nor the rights of others.

onsemi, **Onsemi**, and other names, marks, and brands are registered and/or common law trademarks of Semiconductor Components Industries, LLC dba "**onsemi**" or its affiliates and/or subsidiaries in the United States and/or other countries. **onsemi** owns the rights to a number of patents, trademarks, copyrights, trade secrets, and other intellectual property. A listing of **onsemi**'s product/patent coverage may be accessed at www.onsemi.com/site/pdf/Patent-Marking.pdf. **onsemi** reserves the right to make changes at any time to any products or information herein, without notice. The information herein is provided "as-is" and **onsemi** makes no warranty, representation or guarantee regarding the accuracy of the information, product features, availability, functionality, or suitability of its products for any particular purpose, nor does **onsemi** assume any liability arising out of the application or use of any product or circuit, and specifically disclaims any and all liability, including without limitation special, consequential or incidental damages. Buyer is responsible for its products and applications using **onsemi** products, including compliance with all laws, regulations and safety requirements or standards, regardless of any support or applications information provided by **onsemi**. "Typical" parameters which may be provided in **onsemi** data sheets and/or specifications can and do vary in different applications and actual performance may vary over time. All operating parameters, including "Typicals" must be validated for each customer application by customer's technical experts. **onsemi** does not convey any license under any of its intellectual property rights nor the rights of others. **onsemi** products are not designed, intended, or authorized for use as a critical component in life support systems or any FDA Class 3 medical devices or medical devices with a same or similar classification in a foreign jurisdiction or any devices intended for implantation in the human body. Should Buyer purchase or use **onsemi** products for any such unintended or unauthorized application, Buyer shall indemnify and hold **onsemi** and its officers, employees, subsidiaries, affiliates, and distributors harmless against all claims, costs, damages, and expenses, and reasonable attorney fees arising out of, directly or indirectly, any claim of personal injury or death associated with such unintended or unauthorized use, even if such claim alleges that **onsemi** was negligent regarding the design or manufacture of the part. **onsemi** is an Equal Opportunity/Affirmative Action Employer. This literature is subject to all applicable copyright laws and is not for resale in any manner.

ADDITIONAL INFORMATION

TECHNICAL PUBLICATIONS:

Technical Library: www.onsemi.com/design/resources/technical-documentation
onsemi Website: www.onsemi.com

ONLINE SUPPORT: www.onsemi.com/support

For additional information, please contact your local Sales Representative at www.onsemi.com/support/sales