

IGBT - Field Stop, Trench 650 V, 75 A

FGH75T65UPD-F085

Description

Using Novel Field Stop Trench IGBT Technology, ON Semiconductor's new series of Field Stop Trench IGBTs offer the optimum performance for Automotive chargers, Solar Inverter, UPS and Digital Power Generator where low conduction and switching losses are essential.

Features

- Maximum Junction Temperature : $T_J = 175^\circ\text{C}$
- Positive Temperature Co-efficient for Easy Parallel Operating
- High Current Capability
- Low Saturation Voltage: $V_{CE(sat)} = 1.65\text{ V (Typ.) @ } I_C = 75\text{ A}$
- High Input Impedance
- Tightened Parameter Distribution
- AEC-Q101 Qualified and PPAP Capable
- This Device is Pb-Free and is RoHS Compliant

Applications

- Automotive Chargers, Converters, High Voltage Auxiliaries
- Solar Inverters, UPS, Digital Power Generator



ON Semiconductor®

www.onsemi.com

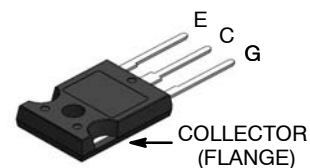
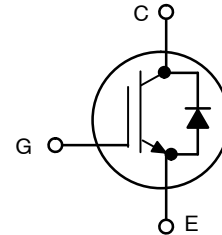

TO-247-3LD
CASE 340CK

MARKING DIAGRAM

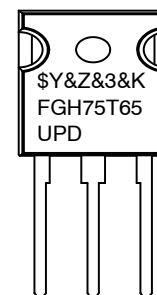

\$Y	= ON Semiconductor Logo
&Z	= Assembly Plant Code
&3	= Numeric Date Code
&K	= Lot Code
FGH75T65UPD	= Specific Device Code

ORDERING INFORMATION

See detailed ordering and shipping information on page 2 of this data sheet.

FGH75T65UPD-F085

ABSOLUTE MAXIMUM RATINGS

Description	Symbol	Ratings	Unit	
Collector to Emitter Voltage	V_{CES}	650	V	
Gate to Emitter Voltage	V_{GES}	± 20	V	
Collector Current	I_C	$T_C = 25^\circ\text{C}$	150	A
		$T_C = 100^\circ\text{C}$	75	A
Pulsed Collector Current	I_{CM} (Note 1)	225	A	
Diode Forward Current	I_F	$T_C = 25^\circ\text{C}$	75	A
		$T_C = 100^\circ\text{C}$	50	A
Pulsed Diode Maximum Forward Current	I_{FM} (Note 1)	225	A	
Maximum Power Dissipation	P_D	$T_C = 25^\circ\text{C}$	375	W
		$T_C = 100^\circ\text{C}$	187	W
Short Circuit Withstand Time	$SCWT$	5	μs	
Operating Junction Temperature	T_J	-55 to +175	$^\circ\text{C}$	
Storage Temperature Range	T_{stg}	-55 to +175	$^\circ\text{C}$	
Maximum Lead Temperature for Soldering, 1/8" from Case for 5 Seconds	T_L	300	$^\circ\text{C}$	

Stresses exceeding those listed in the Maximum Ratings table may damage the device. If any of these limits are exceeded, device functionality should not be assumed, damage may occur and reliability may be affected.

1. Repetitive rating: Pulse width limited by max. junction temperature.

THERMAL CHARACTERISTICS

Parameter	Symbol	Ratings	Unit
Thermal Resistance, Junction-to-Case	$R_{\theta JC}$ (IGBT) (Note 2)	0.4	$^\circ\text{C}/\text{W}$
Thermal Resistance, Junction-to-Case	$R_{\theta JC}$ (Diode)	0.86	$^\circ\text{C}/\text{W}$
Parameter	Symbol	Typ	
Thermal Resistance, Junction-to-Ambient (PCB Mount) (Note 2)	$R_{\theta JA}$	40	$^\circ\text{C}/\text{W}$

PACKAGE MARKING AND ORDERING INFORMATION

Part Number	Top Mark	Package	Package Method	Reel Size	Tape Width	Quantity
FGH75T65UPD-F085	FGH75T65UPD	TO-247	Tube	-	-	30

ELECTRICAL CHARACTERISTICS OF THE IGBT ($T_C = 25^\circ\text{C}$ unless otherwise noted)

Parameter	Symbol	Test Conditions	Min	Typ	Max	Unit
-----------	--------	-----------------	-----	-----	-----	------

OFF CHARACTERISTICS

Collector to Emitter Breakdown Voltage	BV_{CES}	$V_{GE} = 0\text{ V}, I_C = 1\text{ mA}$	650	-	-	V
Temperature Coefficient of Breakdown Voltage	$\Delta BV_{CES} / \Delta T_J$	$V_{GE} = 0\text{ V}, I_C = 1\text{ mA}$	-	0.65	-	$V/^\circ\text{C}$
Collector Cut-Off Current	I_{CES}	$V_{CE} = V_{CES}, V_{GE} = 0\text{ V}$	-	-	250	μA
		I_{CES} at 80% * $BV_{CES}, 175^\circ\text{C}$	-	-	3600	
G-E Leakage Current	I_{GES}	$V_{GE} = V_{GES}, V_{CE} = 0\text{ V}$	-	-	± 400	nA

ON CHARACTERISTICS

G-E Threshold Voltage	$V_{GE(th)}$	$I_C = 75\text{ mA}, V_{CE} = V_{GE}$	4.0	6.0	7.5	V
Collector to Emitter Saturation Voltage	$V_{CE(sat)}$	$I_C = 75\text{ A}, V_{GE} = 15\text{ V}$	-	1.69	2.3	V
		$I_C = 75\text{ A}, V_{GE} = 15\text{ V}, T_C = 175^\circ\text{C}$	-	2.21	-	V

FGH75T65UPD-F085

ELECTRICAL CHARACTERISTICS OF THE IGBT ($T_C = 25^\circ\text{C}$ unless otherwise noted) (continued)

Parameter	Symbol	Test Conditions	Min	Typ	Max	Unit
DYNAMIC CHARACTERISTICS						
Input Capacitance	C_{ies}	$V_{CE} = 30\text{ V}, V_{GE} = 0\text{ V}, f = 1\text{ MHz}$	-	5665	-	pF
Output Capacitance	C_{oes}		-	205	-	pF
Reverse Transfer Capacitance	C_{res}		-	100	-	pF
SWITCHING CHARACTERISTICS						
Turn-On Delay Time	$t_{d(on)}$	$V_{CC} = 400\text{ V}, I_C = 75\text{ A},$ $R_G = 3\ \Omega, V_{GE} = 15\text{ V},$ Inductive Load, $T_C = 25^\circ\text{C}$	-	32	48	ns
Rise Time	t_r		-	43	71	ns
Turn-Off Delay Time	$t_{d(off)}$		-	166	216	ns
Fall Time	t_f		-	24	33	ns
Turn-On Switching Loss	E_{on}		-	2.85	4.80	mJ
Turn-Off Switching Loss	E_{off}		-	1.20	1.60	mJ
Total Switching Loss	E_{ts}		-	4.05	5.30	mJ
Turn-On Delay Time	$t_{d(on)}$	$V_{CC} = 400\text{ V}, I_C = 75\text{ A},$ $R_G = 3\ \Omega, V_{GE} = 15\text{ V},$ Inductive Load, $T_C = 175^\circ\text{C}$	-	30	-	ns
Rise Time	t_r		-	57	-	ns
Turn-Off Delay Time	$t_{d(off)}$		-	176	-	ns
Fall Time	t_f		-	21	-	ns
Turn-On Switching Loss	E_{on}		-	4.45	-	mJ
Turn-Off Switching Loss	E_{off}		-	1.60	-	mJ
Total Switching Loss	E_{ts}		-	6.05	-	mJ
Short Circuit Withstand Time	T_{sc}	$V_{GE} = 15\text{ V}, V_{CC} \leq 400\text{V}, R_G = 10\ \Omega$	5	-	-	μs
Total Gate Charge	Q_g	$V_{CE} = 400\text{ V}, I_C = 75\text{ A}, V_{GE} = 15\text{ V}$	-	385	578	nC
Gate to Emitter Charge	Q_{ge}		-	45	68	nC
Gate to Collector Charge	Q_{gc}		-	210	315	nC

ELECTRICAL CHARACTERISTICS OF THE DIODE ($T_J = 25^\circ\text{C}$ unless otherwise noted)

Parameter	Symbol	Test Conditions	Min	Typ	Max	Unit	
Diode Forward Voltage	V_{FM}	$I_F = 50\text{ A}$	$T_C = 25^\circ\text{C}$	-	2.1	2.6	V
			$T_C = 175^\circ\text{C}$	-	1.7	-	
Reverse Recovery Energy	E_{rec}	$I_F = 50\text{ A}, dI_F/dt = 200\text{ A}/\mu\text{s}$	$T_C = 175^\circ\text{C}$	-	40	-	μJ
Diode Reverse Recovery Time	t_{rr}		$T_C = 25^\circ\text{C}$	-	43	85	ns
			$T_C = 175^\circ\text{C}$	-	162	-	
Diode Reverse Recovery Charge	Q_{rr}		$T_C = 25^\circ\text{C}$	-	83	170	nC
		$T_C = 175^\circ\text{C}$	-	805	-		

Product parametric performance is indicated in the Electrical Characteristics for the listed test conditions, unless otherwise noted. Product performance may not be indicated by the Electrical Characteristics if operated under different conditions.

- $R\theta_{jc}$ for TO-247 : according to Mil standard 883-1012 test method. $R\theta_{ja}$ for TO-247 : according to JESD51-2, test method environmental condition and JESD51-10, test boards for through hole perimeter leaded package thermal measurements. JESD51-3 : Low Effective Thermal Conductivity Test Board for Leaded Surface Mount Package.

TYPICAL PERFORMANCE CHARACTERISTICS

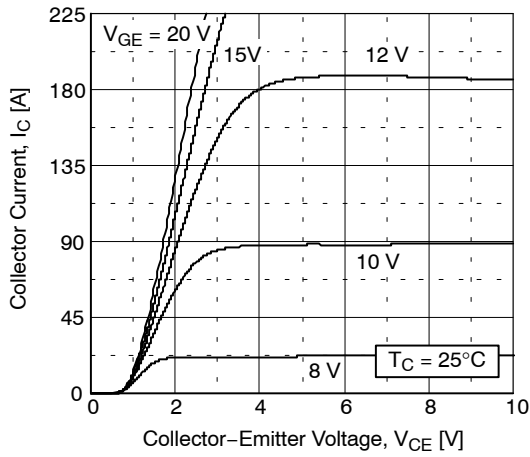

Figure 1. Typical Output Characteristics

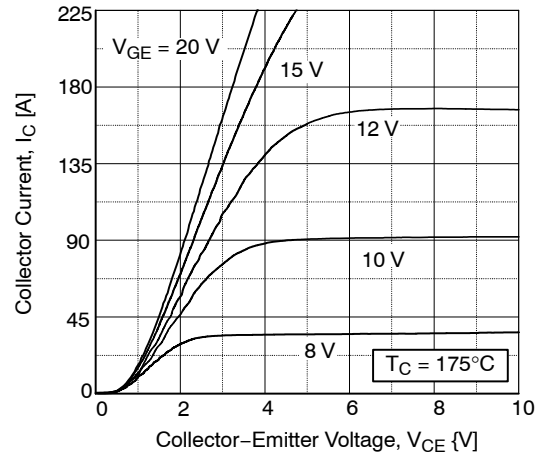

Figure 2. Typical Output Characteristics

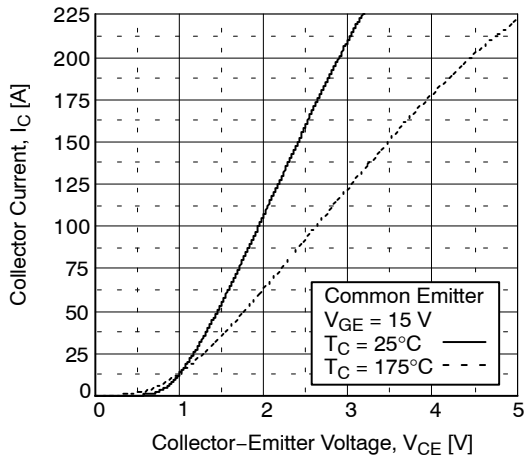

Figure 3. Typical Saturation Voltage Characteristics

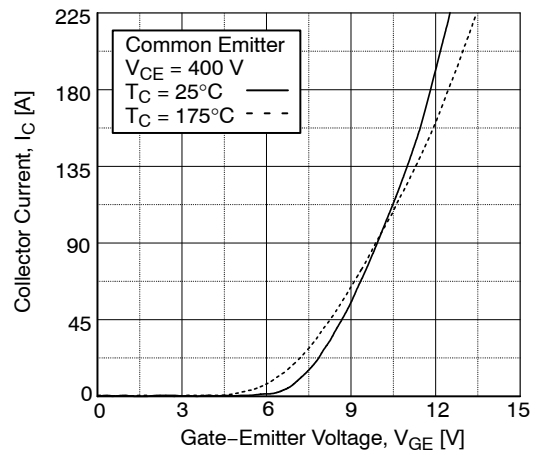

Figure 4. Transfer Characteristics

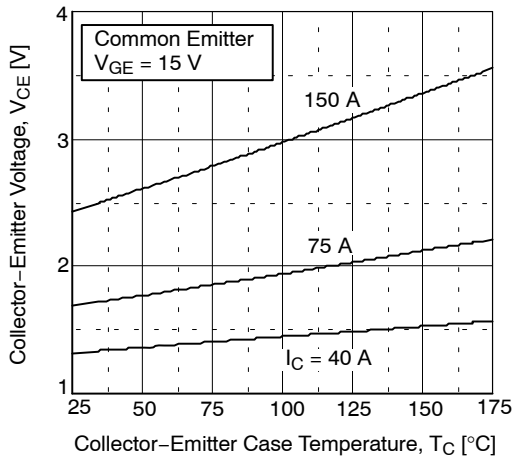

Figure 5. Saturation Voltage vs. Case Temperature at Variant Current Level

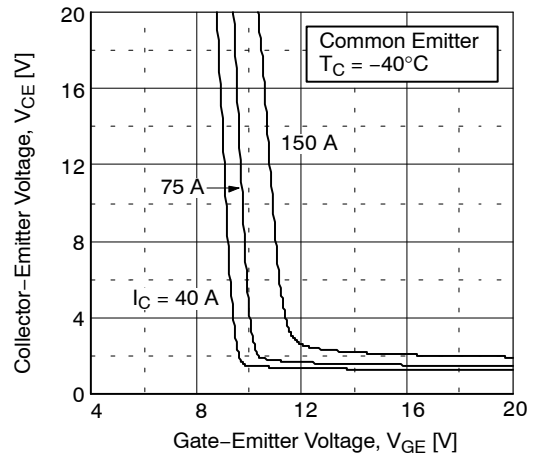

Figure 6. Saturation Voltage vs. V_{GE}

TYPICAL PERFORMANCE CHARACTERISTICS (continued)

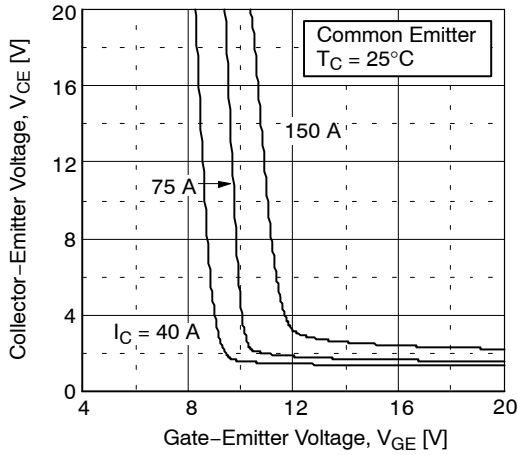

Figure 7. Saturation Voltage vs. V_{GE}

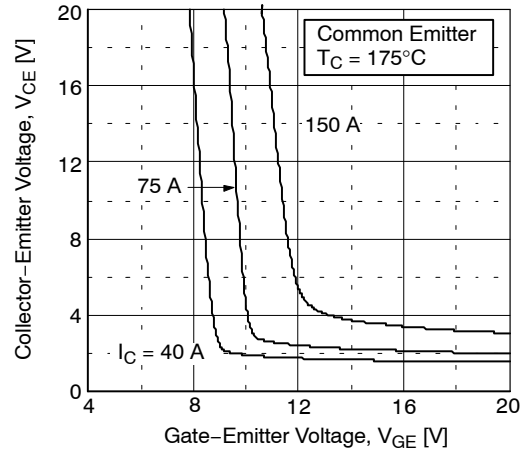

Figure 8. Saturation Voltage vs. V_{GE}

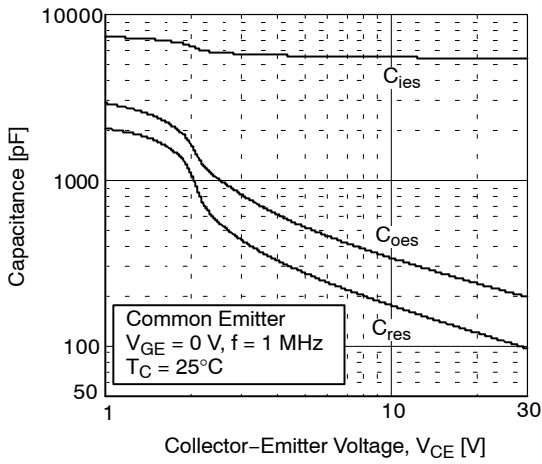

Figure 9. Capacitance Characteristics

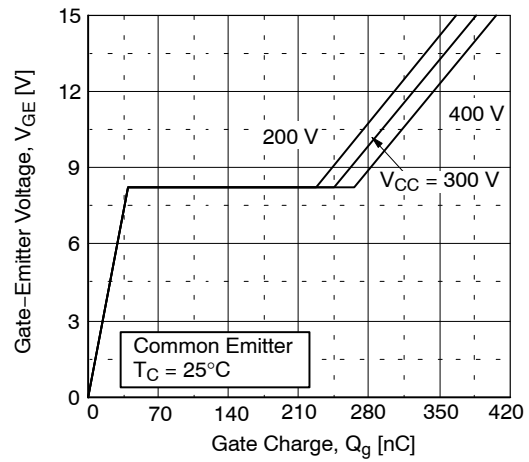

Figure 10. Gate Charge Characteristics

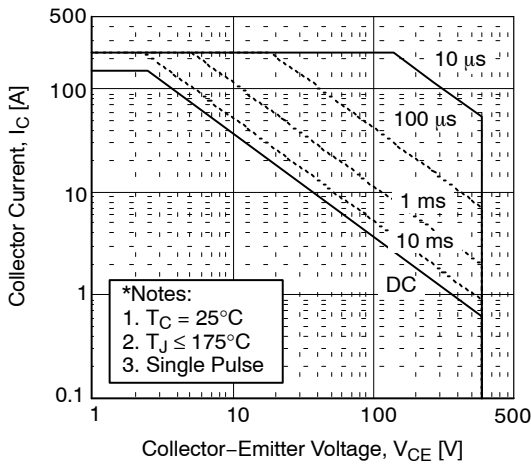

Figure 11. SOA Characteristics

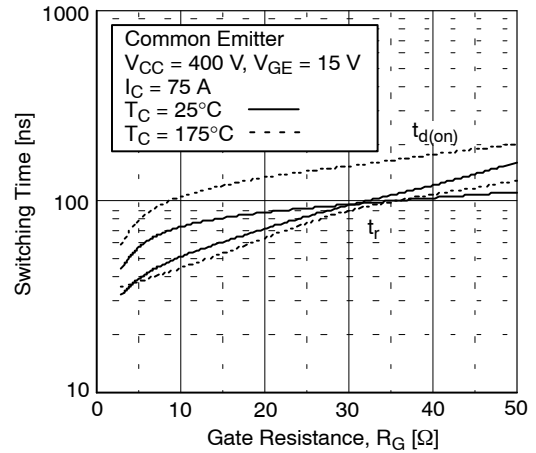

Figure 12. Turn-on Characteristics vs. Gate Resistance

TYPICAL PERFORMANCE CHARACTERISTICS (continued)

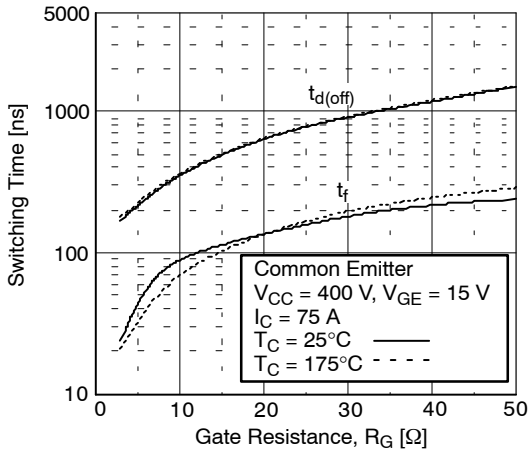

Figure 13. Turn-off Characteristics vs. Gate Resistance

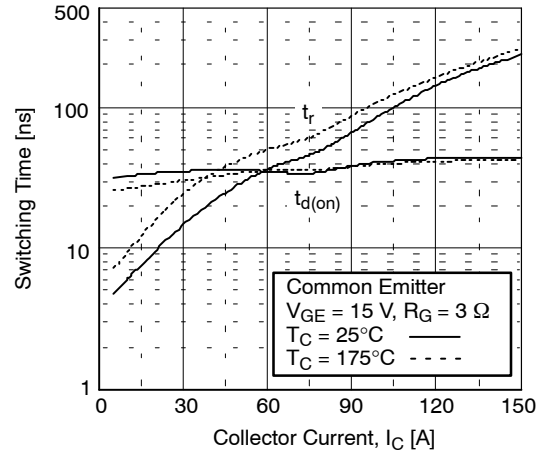

Figure 14. Turn-on Characteristics vs. Collector Current

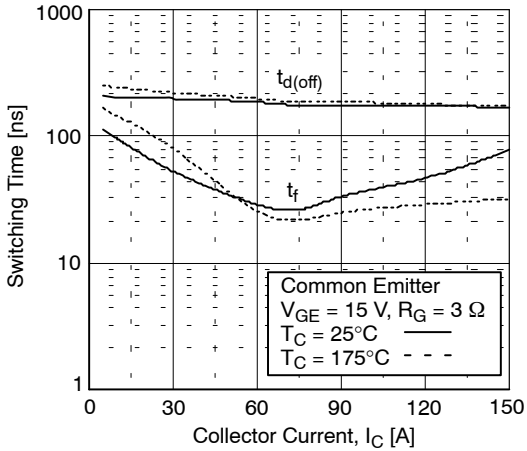

Figure 15. Turn-off Characteristics vs. Collector Current

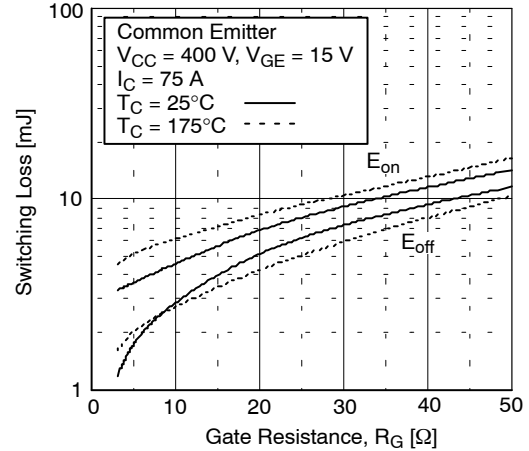

Figure 16. Switching Loss vs. Gate Resistance

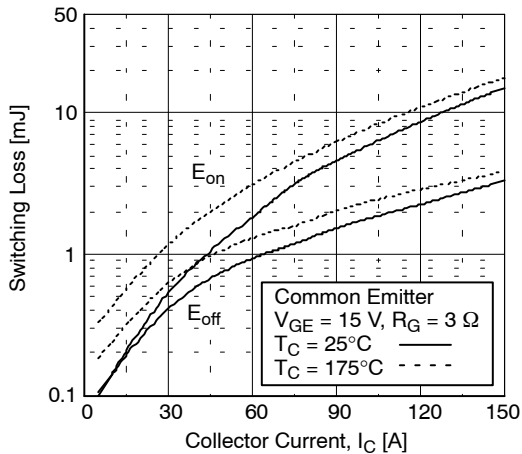

Figure 17. Switching Loss vs. Collector Current

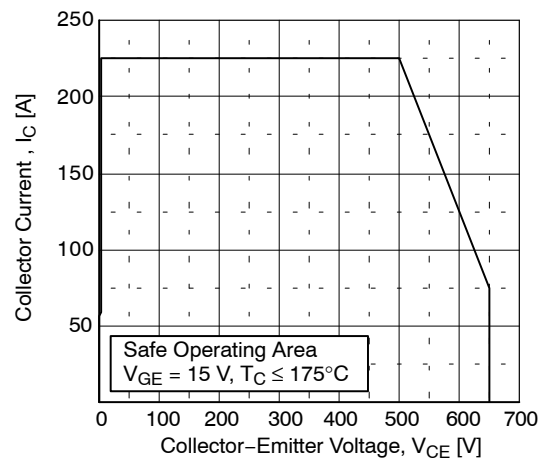

Figure 18. Turn-off Switching SOA Characteristics

TYPICAL PERFORMANCE CHARACTERISTICS (continued)

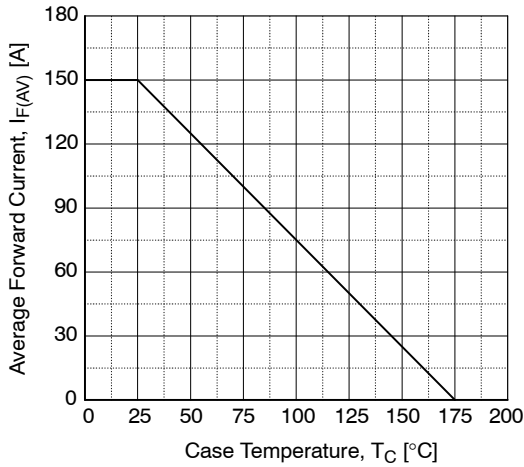

Figure 19. Current Derating

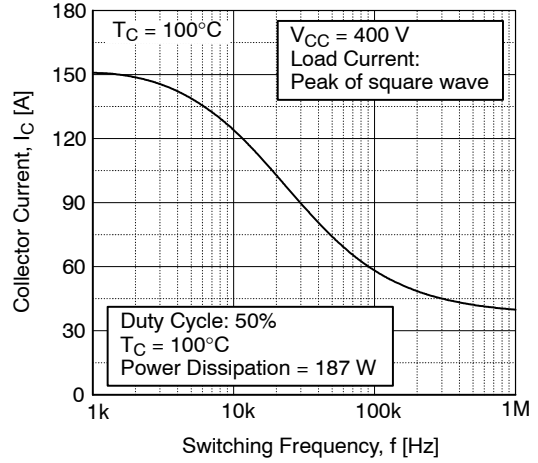

Figure 20. Load Current vs. Frequency

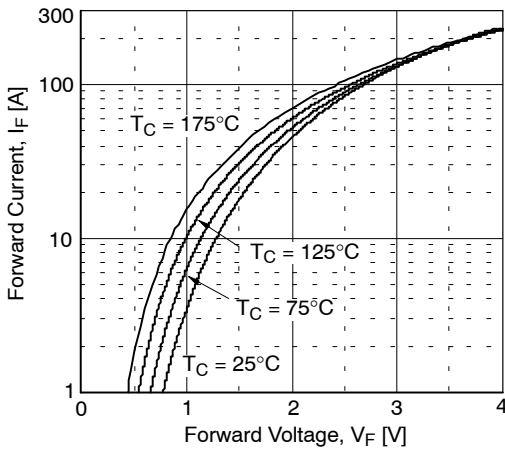

Figure 21. Forward Characteristics

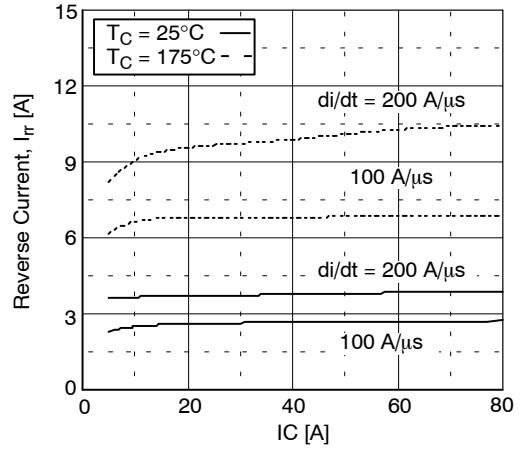

Figure 22. Reverse Recovery Time

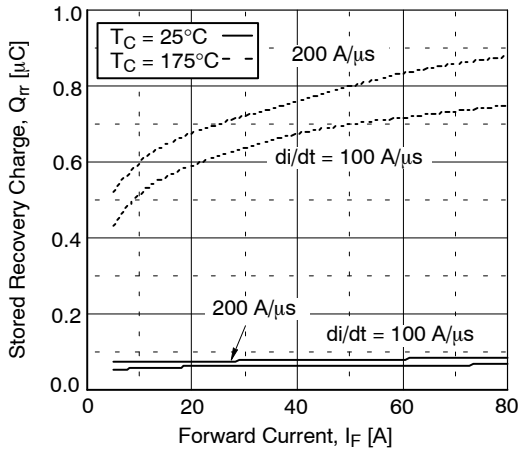

Figure 23. Stored Charge

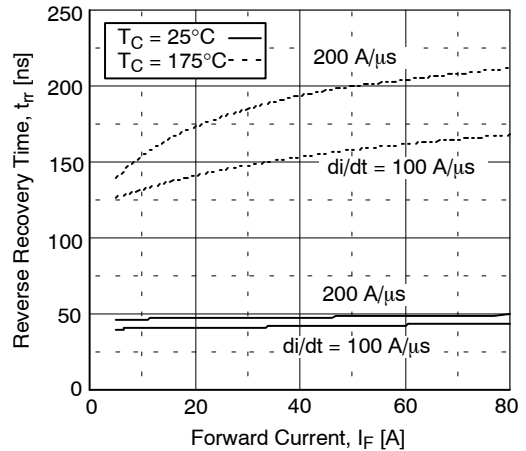

Figure 24. Reverse Recovery Time

TYPICAL PERFORMANCE CHARACTERISTICS (continued)

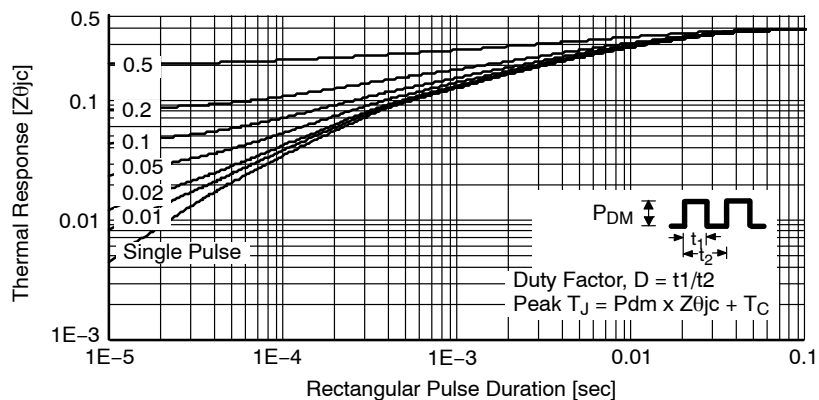

Figure 25. Transient Thermal Impedance of IGBT

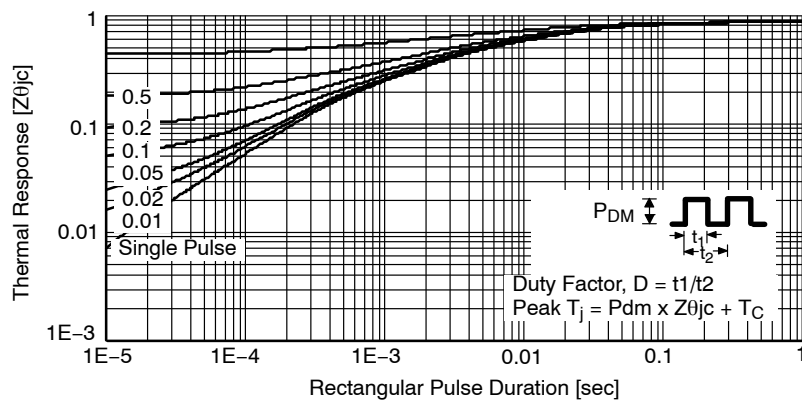

Figure 26. Transient Thermal Impedance of Diode

TO-247-3LD SHORT LEAD
CASE 340CK
ISSUE A

DATE 31 JAN 2019



NOTES: UNLESS OTHERWISE SPECIFIED.

- A. DIMENSIONS ARE EXCLUSIVE OF BURRS, MOLD FLASH, AND TIE BAR EXTRUSIONS.
- B. ALL DIMENSIONS ARE IN MILLIMETERS.
- C. DRAWING CONFORMS TO ASME Y14.5 - 2009.
- D. DIMENSION A1 TO BE MEASURED IN THE REGION DEFINED BY L1.
- E. LEAD FINISH IS UNCONTROLLED IN THE REGION DEFINED BY L1.

GENERIC MARKING DIAGRAM*



- XXXX = Specific Device Code
- A = Assembly Location
- Y = Year
- WW = Work Week
- ZZ = Assembly Lot Code

*This information is generic. Please refer to device data sheet for actual part marking. Pb-Free indicator, "G" or microdot "•", may or may not be present. Some products may not follow the Generic Marking.

DIM	MILLIMETERS		
	MIN	NOM	MAX
A	4.58	4.70	4.82
A1	2.20	2.40	2.60
A2	1.40	1.50	1.60
b	1.17	1.26	1.35
b2	1.53	1.65	1.77
b4	2.42	2.54	2.66
c	0.51	0.61	0.71
D	20.32	20.57	20.82
D1	13.08	~	~
D2	0.51	0.93	1.35
E	15.37	15.62	15.87
E1	12.81	~	~
E2	4.96	5.08	5.20
e	~	5.56	~
L	15.75	16.00	16.25
L1	3.69	3.81	3.93
∅P	3.51	3.58	3.65
∅P1	6.60	6.80	7.00
Q	5.34	5.46	5.58
S	5.34	5.46	5.58

DOCUMENT NUMBER:	98AON13851G	Electronic versions are uncontrolled except when accessed directly from the Document Repository. Printed versions are uncontrolled except when stamped "CONTROLLED COPY" in red.
DESCRIPTION:	TO-247-3LD SHORT LEAD	PAGE 1 OF 1

ON Semiconductor and are trademarks of Semiconductor Components Industries, LLC dba ON Semiconductor or its subsidiaries in the United States and/or other countries. ON Semiconductor reserves the right to make changes without further notice to any products herein. ON Semiconductor makes no warranty, representation or guarantee regarding the suitability of its products for any particular purpose, nor does ON Semiconductor assume any liability arising out of the application or use of any product or circuit, and specifically disclaims any and all liability, including without limitation special, consequential or incidental damages. ON Semiconductor does not convey any license under its patent rights nor the rights of others.

onsemi, **Onsemi**, and other names, marks, and brands are registered and/or common law trademarks of Semiconductor Components Industries, LLC dba "**onsemi**" or its affiliates and/or subsidiaries in the United States and/or other countries. **onsemi** owns the rights to a number of patents, trademarks, copyrights, trade secrets, and other intellectual property. A listing of **onsemi**'s product/patent coverage may be accessed at www.onsemi.com/site/pdf/Patent-Marking.pdf. **onsemi** reserves the right to make changes at any time to any products or information herein, without notice. The information herein is provided "as-is" and **onsemi** makes no warranty, representation or guarantee regarding the accuracy of the information, product features, availability, functionality, or suitability of its products for any particular purpose, nor does **onsemi** assume any liability arising out of the application or use of any product or circuit, and specifically disclaims any and all liability, including without limitation special, consequential or incidental damages. Buyer is responsible for its products and applications using **onsemi** products, including compliance with all laws, regulations and safety requirements or standards, regardless of any support or applications information provided by **onsemi**. "Typical" parameters which may be provided in **onsemi** data sheets and/or specifications can and do vary in different applications and actual performance may vary over time. All operating parameters, including "Typicals" must be validated for each customer application by customer's technical experts. **onsemi** does not convey any license under any of its intellectual property rights nor the rights of others. **onsemi** products are not designed, intended, or authorized for use as a critical component in life support systems or any FDA Class 3 medical devices or medical devices with a same or similar classification in a foreign jurisdiction or any devices intended for implantation in the human body. Should Buyer purchase or use **onsemi** products for any such unintended or unauthorized application, Buyer shall indemnify and hold **onsemi** and its officers, employees, subsidiaries, affiliates, and distributors harmless against all claims, costs, damages, and expenses, and reasonable attorney fees arising out of, directly or indirectly, any claim of personal injury or death associated with such unintended or unauthorized use, even if such claim alleges that **onsemi** was negligent regarding the design or manufacture of the part. **onsemi** is an Equal Opportunity/Affirmative Action Employer. This literature is subject to all applicable copyright laws and is not for resale in any manner.

ADDITIONAL INFORMATION

TECHNICAL PUBLICATIONS:

Technical Library: www.onsemi.com/design/resources/technical-documentation
onsemi Website: www.onsemi.com

ONLINE SUPPORT: www.onsemi.com/support

For additional information, please contact your local Sales Representative at www.onsemi.com/support/sales