

Si/SiC Hybrid Module – EliteSiC, I-Type NPC 1000 V, 350 A IGBT, 1200 V, 100 A SiC Diode, Q2 Package

NXH350N100H4Q2F2

This high-density, integrated power module combines high-performance IGBTs with rugged anti-parallel diodes.

Features

- Extremely Efficient Trench with Field Stop Technology
- Low Switching Loss Reduces System Power Dissipation
- Module Design Offers High Power Density
- Low Inductive Layout
- Low Package Height
- These Devices are Pb-Free, Halogen Free/BFR Free and are RoHS Compliant

Typical Applications

- Solar Inverters
- Uninterruptable Power Supplies Systems

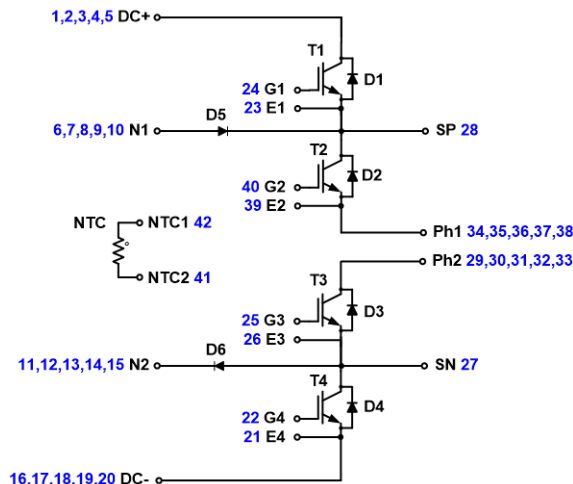
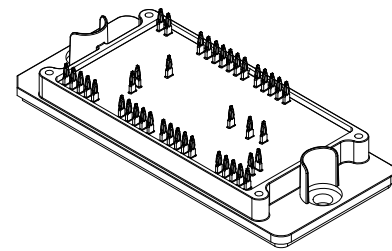
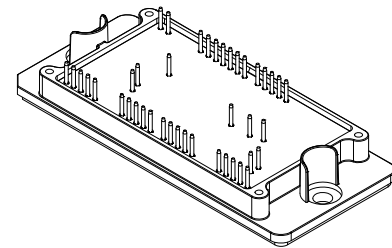

Figure 1. NXH350N100H4Q2F2PG/SG
Schematic Diagram

PACKAGE PICTURE



Q2PACK INPC PRESS FIT PINS
CASE 180BH



Q2PACK INPC SOLDER PINS
CASE 180BS

MARKING DIAGRAM

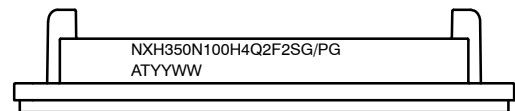

G = Pb-Free Package
AT = Assembly & Test Site Code
YYWW = Year and Work Week Code

PIN CONNECTIONS

See details pin connections on page 2 of this data sheet.

ORDERING INFORMATION

See detailed ordering and shipping information on page 5 of this data sheet.

NXH350N100H4Q2F2

PIN CONNECTIONS

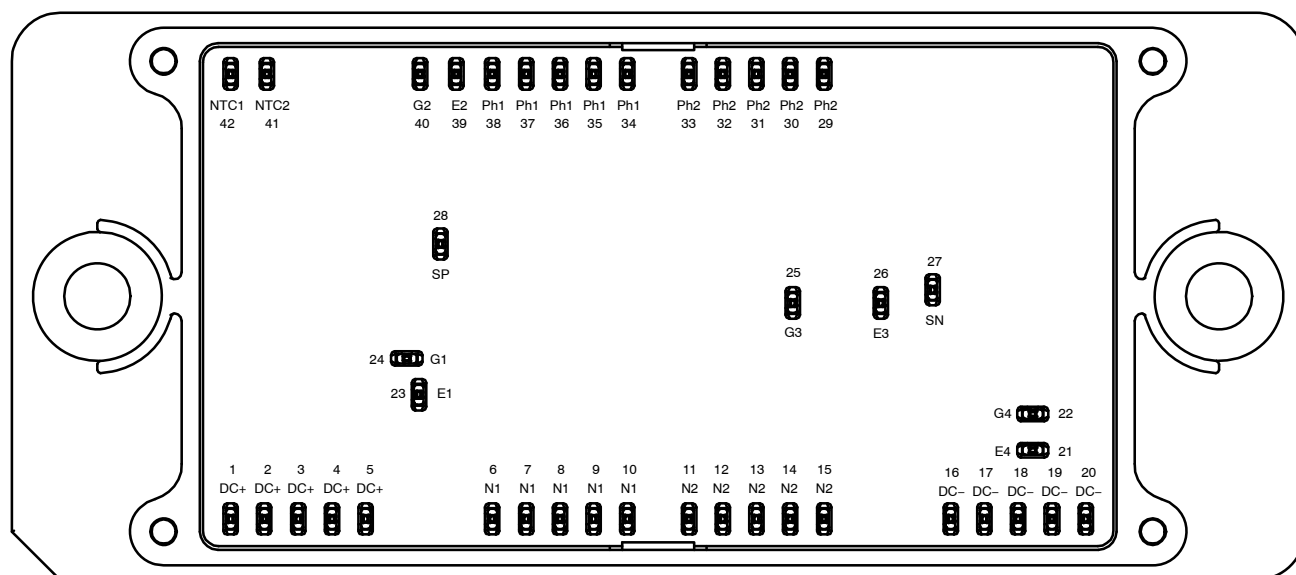

Figure 2. Pin Connections

ABSOLUTE MAXIMUM RATINGS ($T_J = 25^\circ\text{C}$ unless otherwise noted)

Rating	Symbol	Value	Unit
OUTER IGBT (T1, T4)			
Collector-Emitter Voltage	V_{CES}	1000	V
Gate-Emitter Voltage Positive transient gate-emitter voltage ($T_{\text{pulse}} = 5 \mu\text{s}$, $D < 0.10$)	V_{GE}	± 20 30	V
Continuous Collector Current @ $T_C = 80^\circ\text{C}$	I_C	303	A
Pulsed Peak Collector Current @ $T_C = 80^\circ\text{C}$ ($T_J = 150^\circ\text{C}$)	$I_{C(\text{Pulse})}$	909	A
Maximum Power Dissipation ($T_J = 150^\circ\text{C}$)	P_{tot}	592	W
Minimum Operating Junction Temperature	$T_{J\text{MIN}}$	-40	$^\circ\text{C}$
Maximum Operating Junction Temperature	$T_{J\text{MAX}}$	175	$^\circ\text{C}$
INNER IGBT (T2, T3)			
Collector-Emitter Voltage	V_{CES}	1000	V
Gate-Emitter Voltage Positive transient gate-emitter voltage ($T_{\text{pulse}} = 5 \mu\text{s}$, $D < 0.10$)	V_{GE}	± 20 30	V
Continuous Collector Current @ $T_C = 80^\circ\text{C}$	I_C	329	A
Pulsed Peak Collector Current @ $T_C = 80^\circ\text{C}$ ($T_J = 150^\circ\text{C}$)	$I_{C(\text{Pulse})}$	987	A
Maximum Power Dissipation ($T_J = 175^\circ\text{C}$)	P_{tot}	532	W
Minimum Operating Junction Temperature	$T_{J\text{MIN}}$	-40	$^\circ\text{C}$
Maximum Operating Junction Temperature	$T_{J\text{MAX}}$	175	$^\circ\text{C}$
IGBT INVERSE DIODE (D1, D2, D3, D4)			
Peak Repetitive Reverse Voltage	V_{RRM}	1000	V
Continuous Forward Current @ $T_C = 80^\circ\text{C}$	I_F	133	A
Repetitive Peak Forward Current ($T_J = 175^\circ\text{C}$)	I_{FRM}	399	A
Maximum Power Dissipation ($T_J = 175^\circ\text{C}$)	P_{tot}	276	W

NXH350N100H4Q2F2

ABSOLUTE MAXIMUM RATINGS ($T_J = 25^\circ\text{C}$ unless otherwise noted) (continued)

Rating	Symbol	Value	Unit
--------	--------	-------	------

IGBT INVERSE DIODE (D1, D2, D3, D4)

Minimum Operating Junction Temperature	T_{JMIN}	-40	$^\circ\text{C}$
Maximum Operating Junction Temperature	T_{JMAX}	175	$^\circ\text{C}$

NEUTRAL POINT DIODE (D5, D6)

Peak Repetitive Reverse Voltage	V_{RRM}	1200	V
Continuous Forward Current @ $T_C = 80^\circ\text{C}$	I_F	98	A
Repetitive Peak Forward Current ($T_J = 175^\circ\text{C}$)	I_{FRM}	294	A
Maximum Power Dissipation ($T_J = 175^\circ\text{C}$)	P_{tot}	239	W
Minimum Operating Junction Temperature	T_{JMIN}	-40	$^\circ\text{C}$
Maximum Operating Junction Temperature	T_{JMAX}	175	$^\circ\text{C}$

THERMAL PROPERTIES

Operating Temperature under Switching Condition	T_{VJOP}	-40 to +150	$^\circ\text{C}$
Storage Temperature Range	T_{stg}	-40 to +125	$^\circ\text{C}$

INSULATION PROPERTIES

Isolation Test Voltage, $t = 2$ s, 50 Hz (Note 2)	V_{is}	4000	V_{RMS}
Creepage Distance		12.7	mm
Comparative Tracking Index	CTI	> 600	

Stresses exceeding those listed in the Maximum Ratings table may damage the device. If any of these limits are exceeded, device functionality should not be assumed, damage may occur and reliability may be affected.

1. Refer to [ELECTRICAL CHARACTERISTICS](#) and/or APPLICATION INFORMATION for Safe Operating parameters.
2. 4000 VAC_{RMS} for 1 second duration is equivalent to 3333 VAC_{RMS} for 1 minute duration.

ELECTRICAL CHARACTERISTICS ($T_J = 25^\circ\text{C}$ unless otherwise specified)

Characteristic	Test Conditions	Symbol	Min	Typ	Max	Unit
----------------	-----------------	--------	-----	-----	-----	------

OUTER IGBT (T1, T4) CHARACTERISTICS

Collector-Emitter Cutoff Current	$V_{GE} = 0$ V, $V_{CE} = 1000$ V	I_{CES}	-	-	1000	μA	
Collector-Emitter Saturation Voltage	$V_{GE} = 15$ V, $I_C = 375$ A, $T_J = 25^\circ\text{C}$	$V_{CE(sat)}$	-	1.63	1.80	V	
	$V_{GE} = 15$ V, $I_C = 375$ A, $T_J = 150^\circ\text{C}$		-	1.92	-		
Gate-Emitter Threshold Voltage	$V_{GE} = V_{CE}$, $I_C = 375$ mA	$V_{GE(TH)}$	4.1	4.84	5.7	V	
Gate Leakage Current	$V_{GE} = \pm 20$ V, $V_{CE} = 0$ V	I_{GES}	-	-	± 2000	nA	
Turn-on Delay Time	$T_J = 25^\circ\text{C}$ $V_{CE} = 600$ V, $I_C = 170$ A $V_{GE} = -8$ V, 15 V, $R_G = 5$ Ω	$t_{d(on)}$	-	86	-	ns	
Rise Time		t_r	-	30	-		
Turn-off Delay Time		$t_{d(off)}$	-	312	-		
Fall Time		t_f	-	32	-		
Turn-on Switching Loss per Pulse		E_{on}	-	2376	-		μJ
Turn-off Switching Loss per Pulse		E_{off}	-	5437	-		
Turn-on Delay Time	$T_J = 125^\circ\text{C}$ $V_{CE} = 600$ V, $I_C = 170$ A $V_{GE} = -8$ V, 15 V, $R_G = 5$ Ω	$t_{d(on)}$	-	79	-	ns	
Rise Time		t_r	-	35	-		
Turn-off Delay Time		$t_{d(off)}$	-	357	-		
Fall Time		t_f	-	73	-		
Turn-on Switching Loss per Pulse		E_{on}	-	4568	-		μJ
Turn-off Switching Loss per Pulse		E_{off}	-	7421	-		

NXH350N100H4Q2F2

ELECTRICAL CHARACTERISTICS (T_J = 25°C unless otherwise specified) (continued)

Characteristic	Test Conditions	Symbol	Min	Typ	Max	Unit
----------------	-----------------	--------	-----	-----	-----	------

OUTER IGBT (T1, T4) CHARACTERISTICS

Input Capacitance	V _{CE} = 20 V, V _{GE} = 0 V, f = 1 MHz	C _{ies}	–	24146	–	pF
Output Capacitance		C _{oes}	–	1027	–	
Reverse Transfer Capacitance		C _{res}	–	106	–	
Total Gate Charge	V _{CE} = 600 V, I _C = 375 A, V _{GE} = 15 V	Q _g	–	680	–	nC
Thermal Resistance – Chip-to-Heatsink	Thermal grease, Thickness = 2.1 Mil ±2% λ = 2.9 W/mK	R _{thJH}	–	0.22	–	K/W
Thermal Resistance – Chip-to-Case		R _{thJC}	–	0.12	–	K/W

NEUTRAL POINT DIODE (D5, D6) CHARACTERISTICS

Diode Forward Voltage	I _F = 100 A, T _J = 25°C	V _F	–	1.50	1.85	V
	I _F = 100 A, T _J = 150°C		–	2.07	–	
Reverse Recovery Time	T _J = 25°C V _{CE} = 600 V, I _C = 170 A V _{GE} = -8 V, 15 V, R _G = 5 Ω	t _{rr}	–	19	–	ns
Reverse Recovery Charge		Q _{rr}	–	229	–	μC
Peak Reverse Recovery Current		I _{RRM}	–	19	–	A
Peak Rate of Fall of Recovery Current		di/dt	–	6053	–	A/μs
Reverse Recovery Energy		E _{rr}	–	164	–	μJ
Reverse Recovery Time		T _J = 125°C V _{CE} = 600 V, I _C = 120 A V _{GE} = -8 V, 15 V, R _G = 5 Ω	t _{rr}	–	34	–
Reverse Recovery Charge	Q _{rr}		–	359	–	μC
Peak Reverse Recovery Current	I _{RRM}		–	17	–	A
Peak Rate of Fall of Recovery Current	di/dt		–	4621	–	A/μs
Reverse Recovery Energy	E _{rr}		–	211	–	μJ
Thermal Resistance – Chip-to-Heatsink	Thermal grease, Thickness = 2.1 Mil ±2% λ = 2.9 W/mK		R _{thJH}	–	0.42	–
Thermal Resistance – Chip-to-Case		R _{thJC}	–	0.29	–	K/W

INNER IGBT (T2, T3) CHARACTERISTICS

Collector-Emitter Cutoff Current	V _{GE} = 0 V, V _{CE} = 1000 V	I _{CES}	–	–	500	μA	
Collector-Emitter Saturation Voltage	V _{GE} = 15 V, I _C = 300 A, T _J = 25°C	V _{CE(sat)}	–	1.27	1.50	V	
	V _{GE} = 15 V, I _C = 300 A, T _J = 150°C		–	1.34	–		
Gate-Emitter Threshold Voltage	V _{GE} = V _{CE} , I _C = 300 mA	V _{GE(TH)}	4.1	4.96	5.7	V	
Gate Leakage Current	V _{GE} = ±20 V, V _{CE} = 0 V	I _{GES}	–	–	±1600	nA	
Turn-on Delay Time	T _J = 25°C V _{CE} = 600 V, I _C = 170 A V _{GE} = -8 V, 15 V, R _G = 5 Ω	t _{d(on)}	–	69.5	–	ns	
Rise Time		t _r	–	31	–		
Turn-off Delay Time		t _{d(off)}	–	422.5	–		
Fall Time		t _f	–	51.5	–		
Turn-on Switching Loss per Pulse		E _{on}	–	3705	–		μJ
Turn-off Switching Loss per Pulse		E _{off}	–	12590	–		
Turn-on Delay Time	T _J = 125°C V _{CE} = 600 V, I _C = 170 A V _{GE} = -8 V, 15 V, R _G = 5 Ω	t _{d(on)}	–	66	–	ns	
Rise Time		t _r	–	30.5	–		
Turn-off Delay Time		t _{d(off)}	–	508.5	–		
Fall Time		t _f	–	64	–		
Turn-on Switching Loss per Pulse		E _{on}	–	5777	–		μJ
Turn-off Switching Loss per Pulse		E _{off}	–	18390	–		

NXH350N100H4Q2F2

ELECTRICAL CHARACTERISTICS (T_J = 25°C unless otherwise specified) (continued)

Characteristic	Test Conditions	Symbol	Min	Typ	Max	Unit
----------------	-----------------	--------	-----	-----	-----	------

INNER IGBT (T₂, T₃) CHARACTERISTICS

Input Capacitance	V _{CE} = 20 V, V _{GE} = 0 V, f = 1 MHz	C _{ies}	–	25260	–	pF
Output Capacitance		C _{oes}	–	1009	–	
Reverse Transfer Capacitance		C _{res}	–	118	–	
Total Gate Charge	V _{CE} = 600 V, I _C = 300 A, V _{GE} = 15 V	Q _g	–	720	–	nC
Thermal Resistance – Chip-to-Heatsink	Thermal grease, Thickness = 2.1 Mil ±2% λ = 2.9 W/mK	R _{thJH}	–	0.24	–	K/W
Thermal Resistance – Chip-to-Case		R _{thJC}	–	0.13	–	K/W

IGBT INVERSE DIODE (D₁, D₂, D₃, D₄) CHARACTERISTICS

Diode Forward Voltage	I _F = 150 A, T _J = 25°C	V _F	–	2.06	2.44	V	
	I _F = 150 A, T _J = 150°C		–	1.77	–		
Reverse Recovery Time	T _J = 25°C V _{CE} = 600 V, I _C = 170 A V _{GE} = -8 V, 15 V, R _G = 5 Ω	t _{rr}	–	96	–	ns	
Reverse Recovery Charge		Q _{rr}	–	5094	–	μC	
Peak Reverse Recovery Current		I _{RRM}	–	124	–	A	
Peak Rate of Fall of Recovery Current		di/dt	–	4571	–	A/μs	
Reverse Recovery Energy		E _{rr}	–	2069	–	μJ	
Reverse Recovery Time		T _J = 125°C V _{CE} = 600 V, I _C = 170 A V _{GE} = -8 V, 15 V, R _G = 5 Ω	t _{rr}	–	192	–	ns
Reverse Recovery Charge			Q _{rr}	–	11900	–	μC
Peak Reverse Recovery Current			I _{RRM}	–	148	–	A
Peak Rate of Fall of Recovery Current			di/dt	–	4167	–	A/μs
Reverse Recovery Energy			E _{rr}	–	4665	–	μJ
Thermal Resistance – Chip-to-Heatsink	Thermal grease, Thickness = 2.1 Mil ±2% λ = 2.9 W/mK	R _{thJH}	–	0.39	–	K/W	
Thermal Resistance – Chip-to-Case		R _{thJC}	–	0.25	–	K/W	

THERMISTOR CHARACTERISTICS

Nominal Resistance	T = 25°C	R ₂₅	–	22	–	kΩ
Nominal Resistance	T = 100°C	R ₁₀₀	–	1.486	–	kΩ
Deviation of R ₂₅		ΔR/R	-5	–	5	%
Power Dissipation		P _D	–	200	–	mW
Power Dissipation Constant			–	2	–	mW/K
B-value	B(25/50), tolerance ±3%		–	3950	–	K
B-value	B(25/100), tolerance ±3%		–	3998	–	K

Product parametric performance is indicated in the Electrical Characteristics for the listed test conditions, unless otherwise noted. Product performance may not be indicated by the Electrical Characteristics if operated under different conditions.

ORDERING INFORMATION

Part Number	Marking	Package	Shipping
NXH350N100H4Q2F2PG PRESS FIT PINS	NXH350N100H4Q2F2PG	Q2PACK (Pb-free/Halide-free)	12 Units / Blister Tray
NXH350N100H4Q2F2SG SOLDER PINS	NXH350N100H4Q2F2SG	Q2PACK (Pb-free/Halide-free)	12 Units / Blister Tray

NXH350N100H4Q2F2

TYPICAL CHARACTERISTICS – OUTER IGBT, INNER IGBT

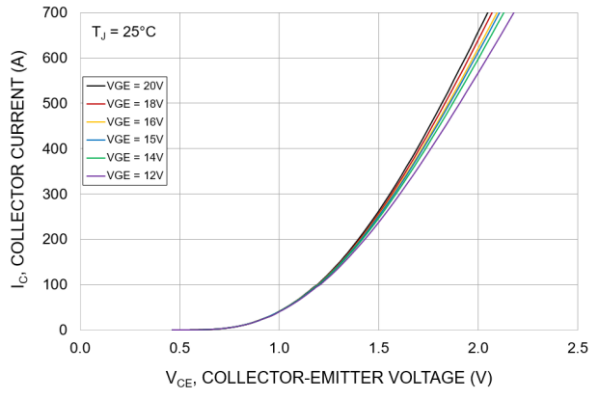

Figure 3. Typical Output Characteristics – Outer IGBT

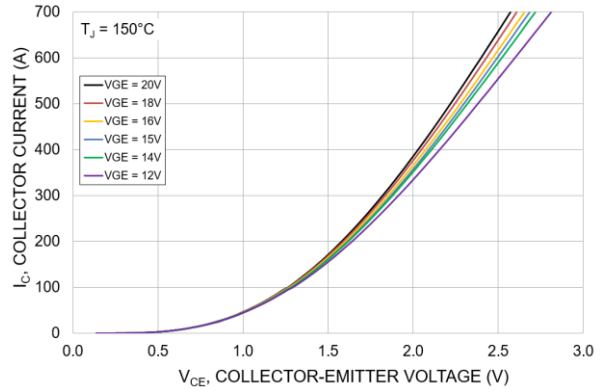

Figure 4. Typical Output Characteristics – Outer IGBT

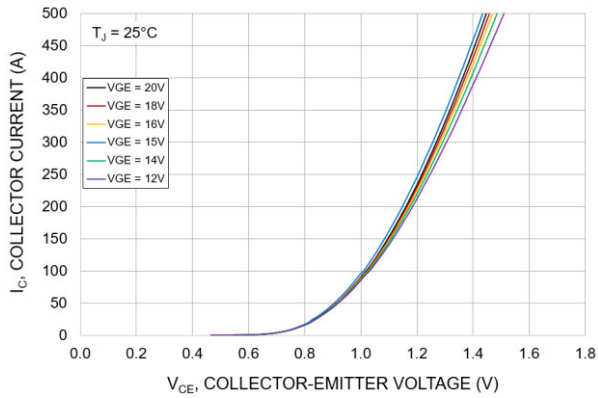

Figure 5. Typical Output Characteristics – Inner IGBT

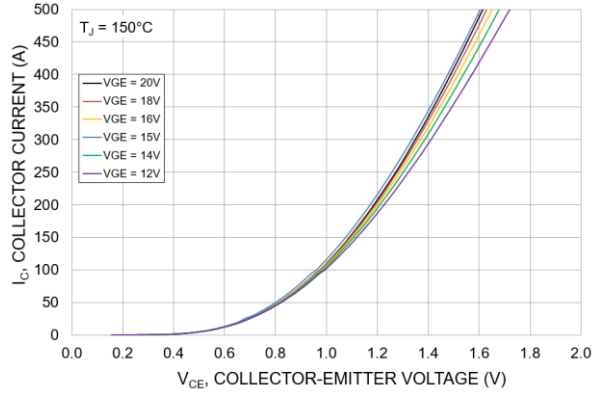

Figure 6. Typical Output Characteristics – Inner IGBT

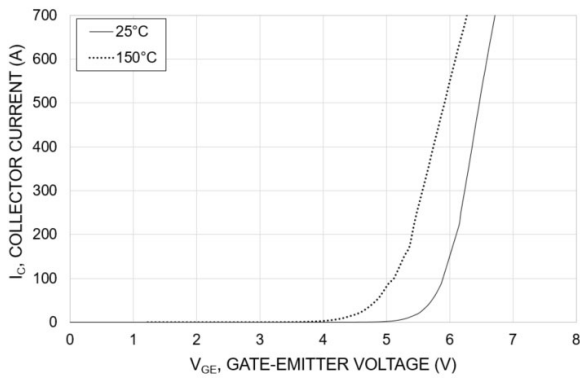

Figure 7. Transfer Characteristics – Outer IGBT

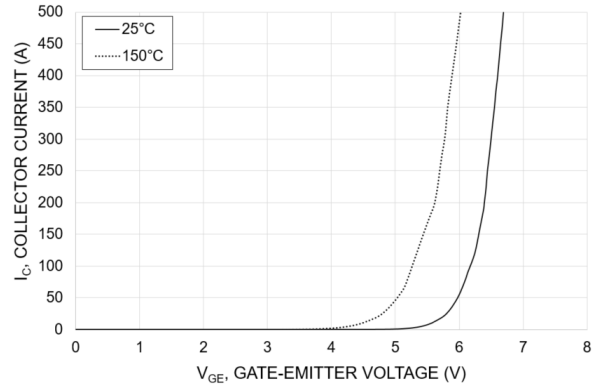

Figure 8. Transfer Characteristics – Inner IGBT

NXH350N100H4Q2F2

TYPICAL CHARACTERISTICS – OUTER IGBT, INNER IGBT, IGBT INVERSE DIODE AND NEUTRAL POINT DIODE

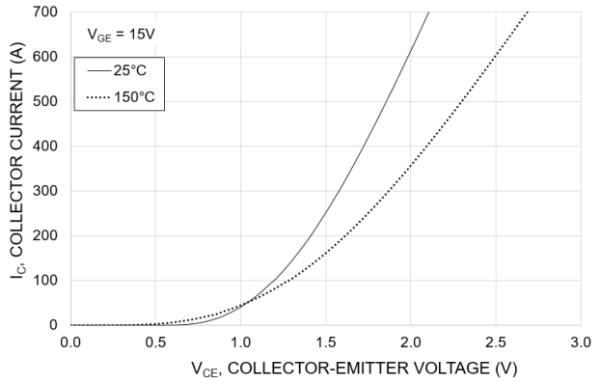

Figure 9. Typical Saturation Voltage Characteristics – Outer IGBT

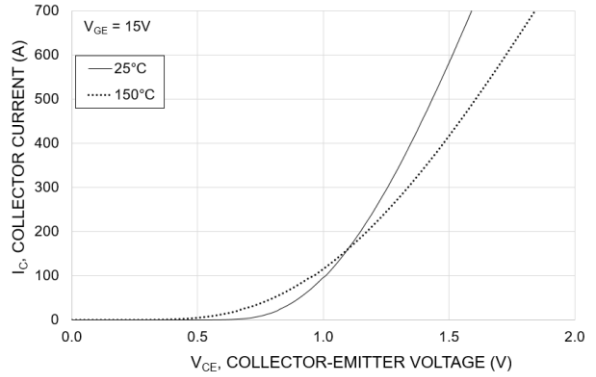

Figure 10. Typical Saturation Voltage Characteristics – Inner IGBT

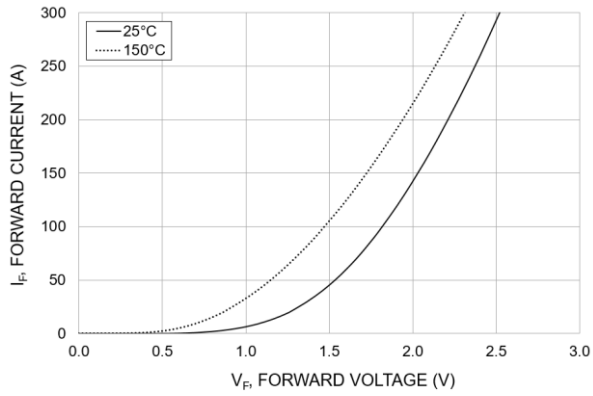

Figure 11. Inverse Diode Forward Characteristics

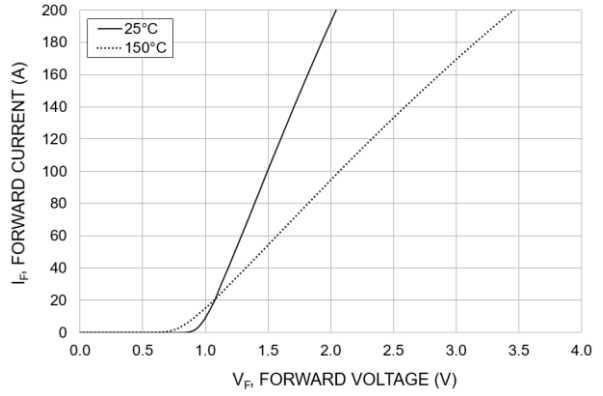

Figure 12. Buck Diode Forward Characteristics

NXH350N100H4Q2F2

TYPICAL SWITCHING CHARACTERISTICS – OUTER IGBT

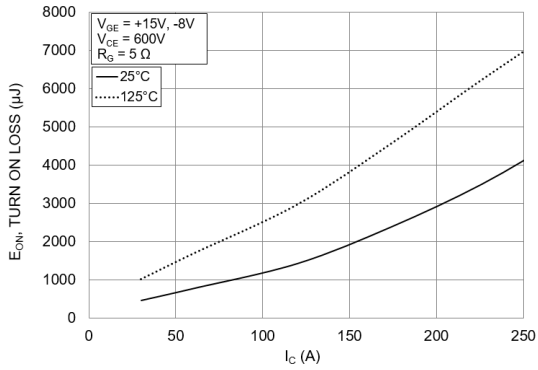

Figure 13. Typical Turn On Loss vs. I_C

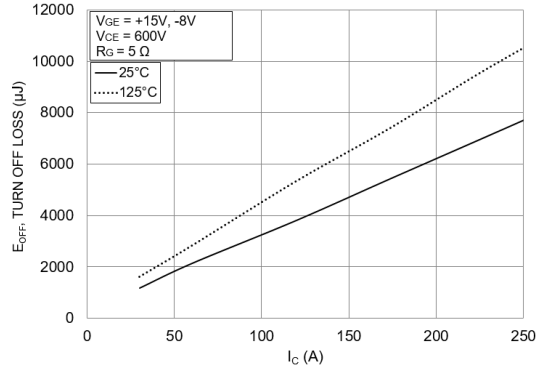

Figure 14. Typical Turn Off Loss vs. I_C

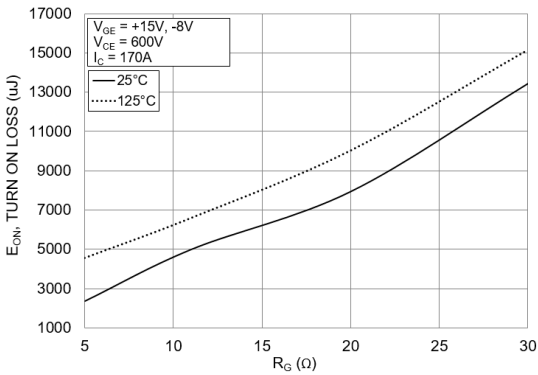

Figure 15. Typical Turn On Loss vs. R_G

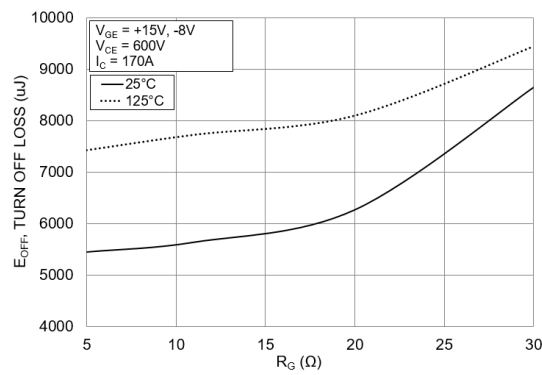

Figure 16. Typical Turn Off Loss vs. R_G

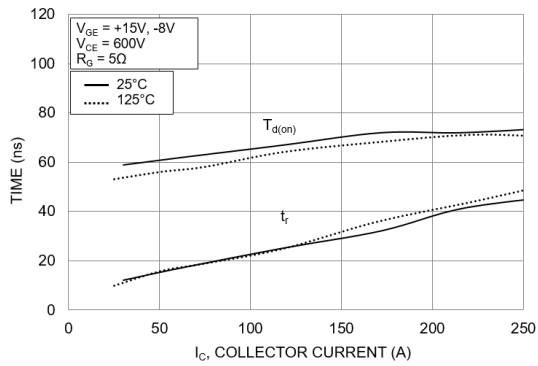

Figure 17. Typical Turn On Switching Time vs. I_C

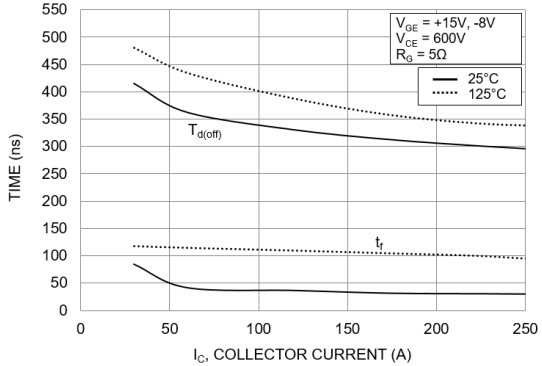

Figure 18. Typical Turn Off Switching Time vs. I_C

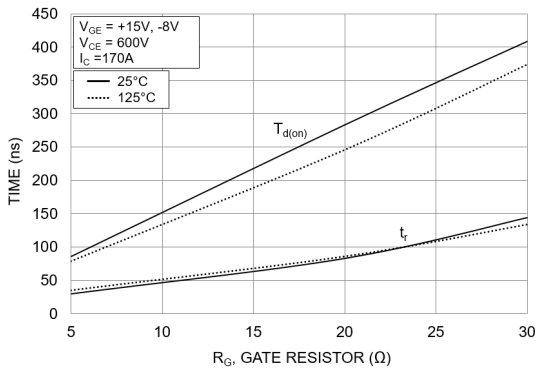

Figure 19. Typical Turn On Switching Time vs. R_G

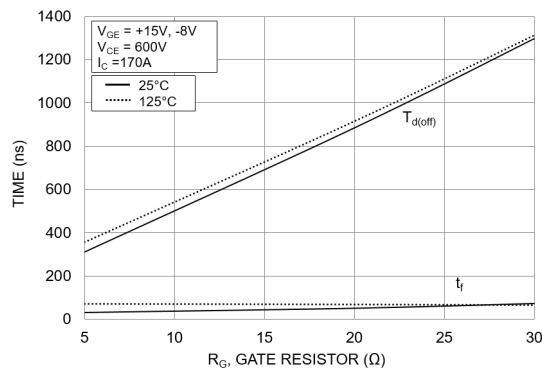

Figure 20. Typical Turn On Switching Time vs. R_G

NXH350N100H4Q2F2

TYPICAL SWITCHING CHARACTERISTICS – INNER IGBT

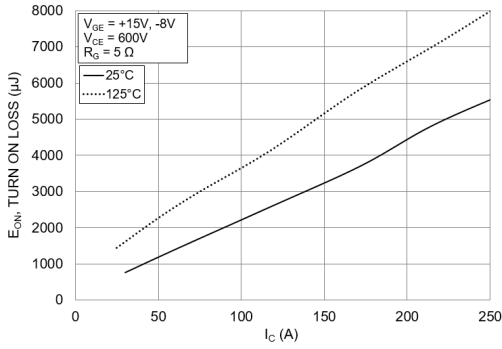

Figure 21. Typical Turn On Loss vs. I_C

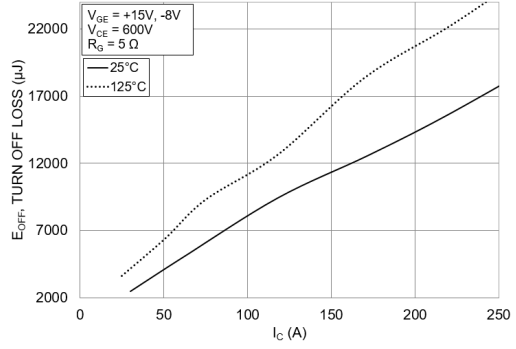

Figure 22. Typical Turn Off Loss vs. I_C

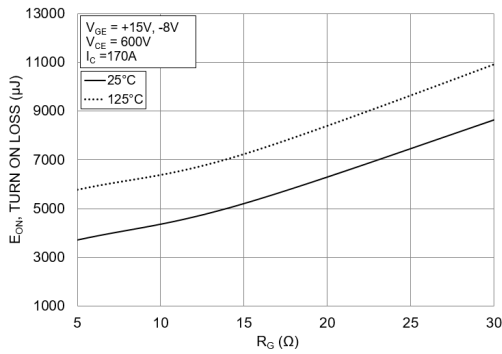

Figure 23. Typical Turn On Loss vs. R_G

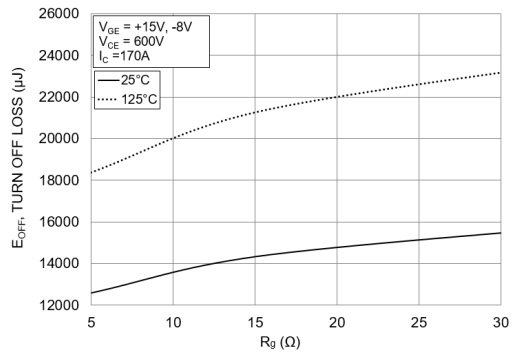

Figure 24. Typical Turn Off Loss vs. R_G

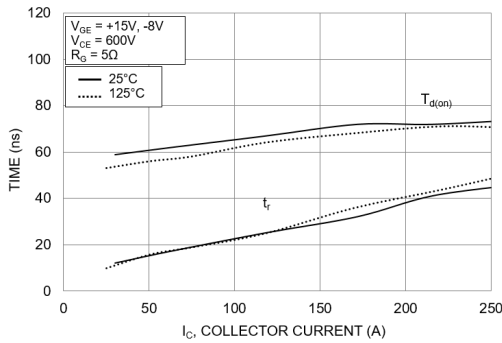

Figure 25. Typical Turn On Switching Time vs. I_C

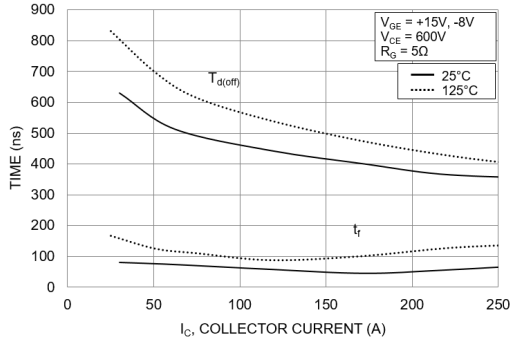

Figure 26. Typical Turn Off Switching Time vs. I_C

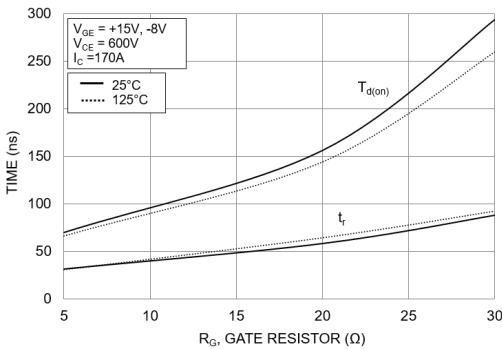

Figure 27. Typical Turn On Switching Time vs. R_G

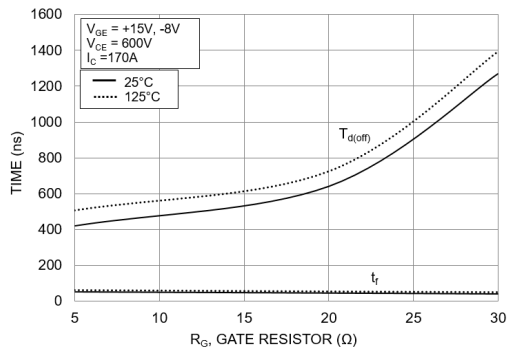

Figure 28. Typical Turn On Switching Time vs. R_G

NXH350N100H4Q2F2

TYPICAL SWITCHING CHARACTERISTICS – INVERSE DIODE

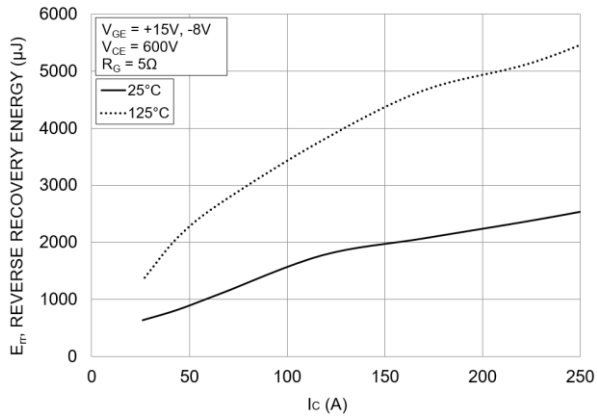

Figure 29. Typical Reverse Recovery Energy Loss vs. I_C

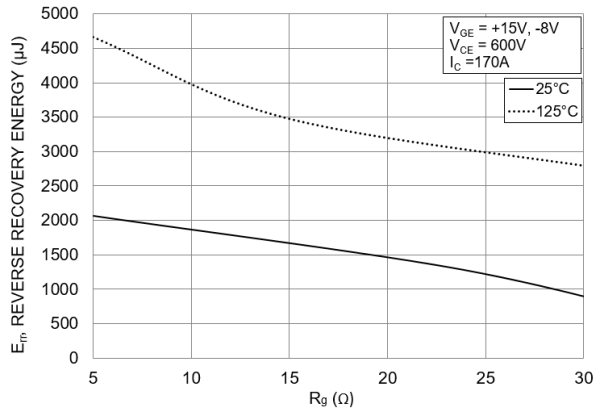

Figure 30. Typical Reverse Recovery Energy Loss vs. R_G

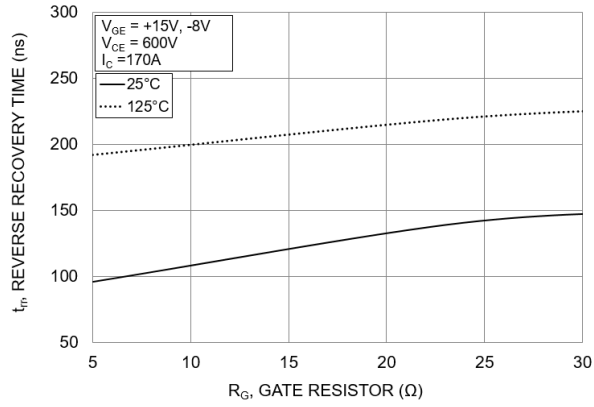

Figure 31. Typical Reverse Recovery Time vs. R_G

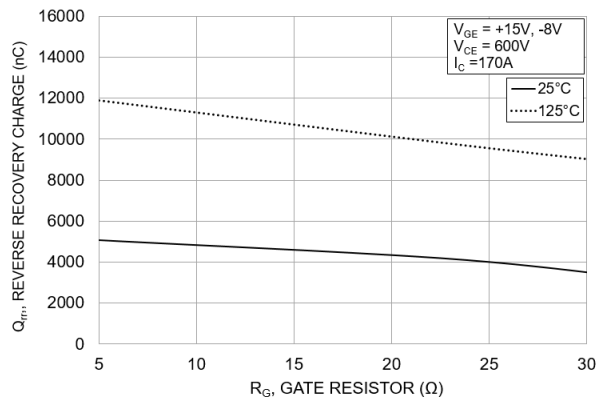

Figure 32. Typical Reverse Recovery Charge vs. R_G

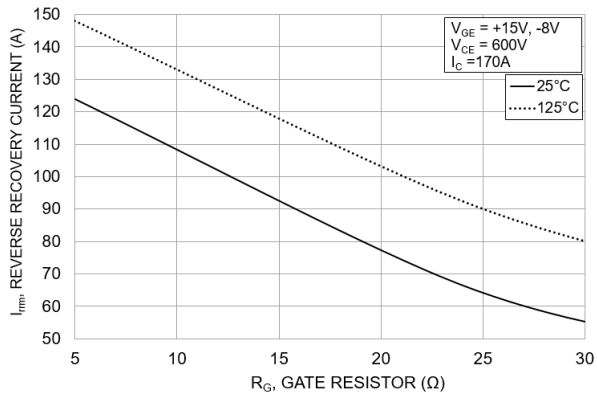

Figure 33. Typical Reverse Recovery Peak Current vs. R_G

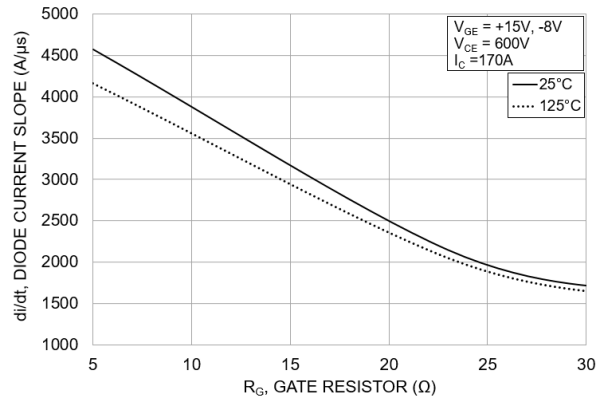

Figure 34. Typical di/dt vs. R_G

NXH350N100H4Q2F2

TYPICAL SWITCHING CHARACTERISTICS – NEUTRAL POINT DIODE

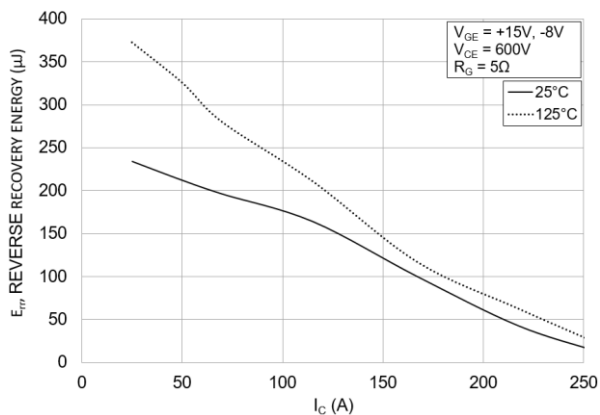

Figure 35. Typical Reverse Recovery Energy Loss vs. I_C

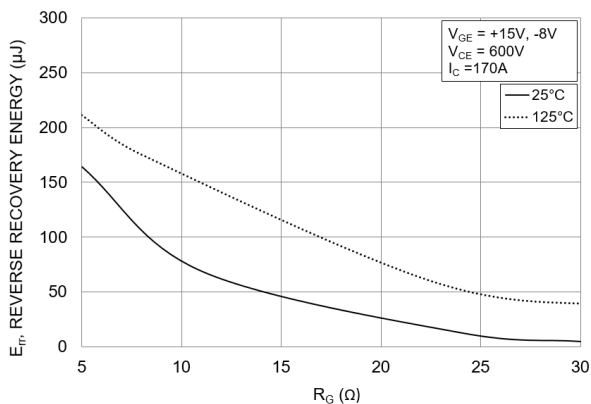

Figure 36. Typical Reverse Recovery Energy Loss vs. R_G

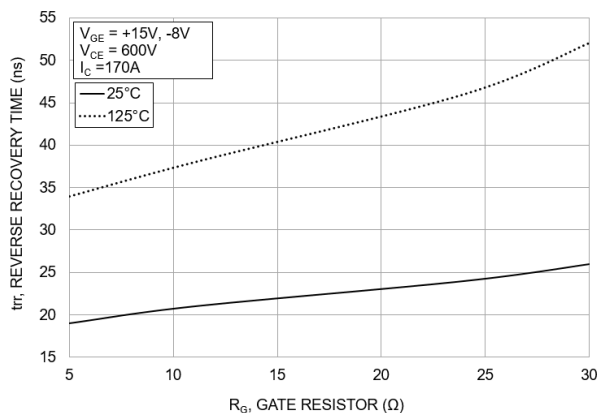

Figure 37. Typical Reverse Recovery Time vs. R_G

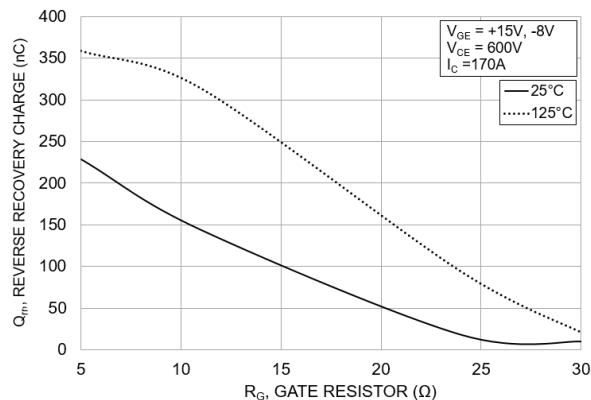

Figure 38. Typical Reverse Recovery Charge vs. R_G

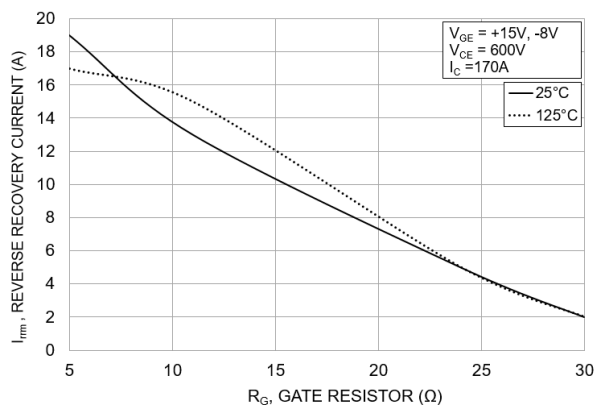

Figure 39. Typical Reverse Recovery Peak Current vs. R_G

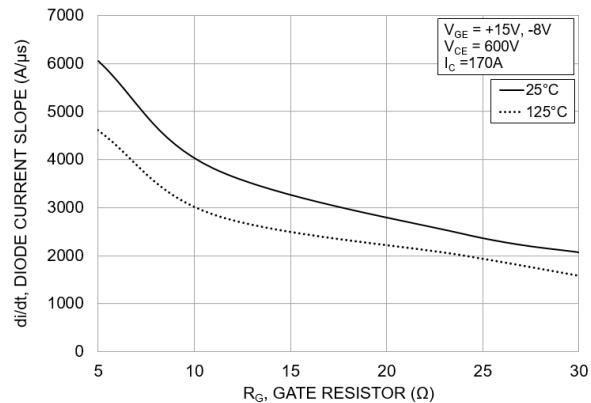

Figure 40. Typical di/dt vs. R_G

NXH350N100H4Q2F2

TRANSIENT THERMAL IMPEDANCE

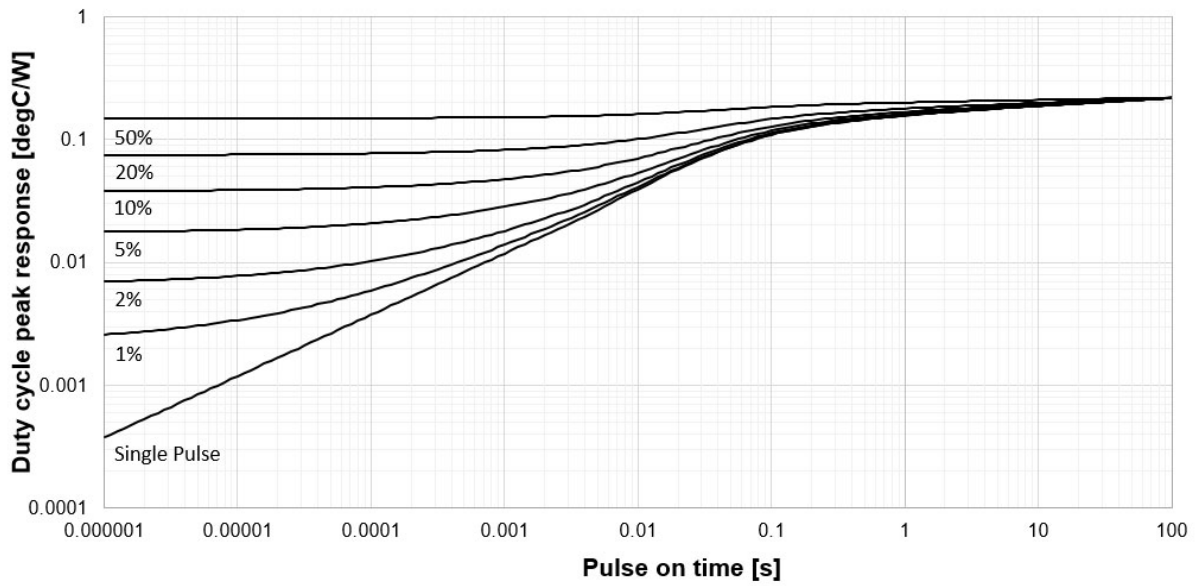

Figure 41. Transient Thermal Impedance – Outer IGBT

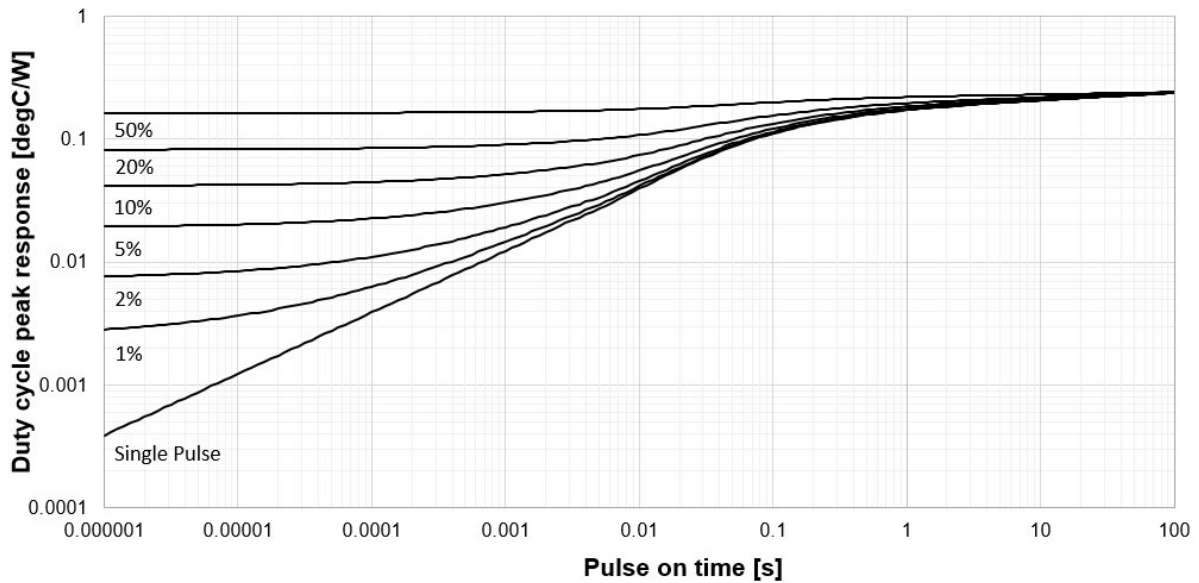

Figure 42. Transient Thermal Impedance – Inner IGBT

NXH350N100H4Q2F2

TRANSIENT THERMAL IMPEDANCE (CONTINUED)

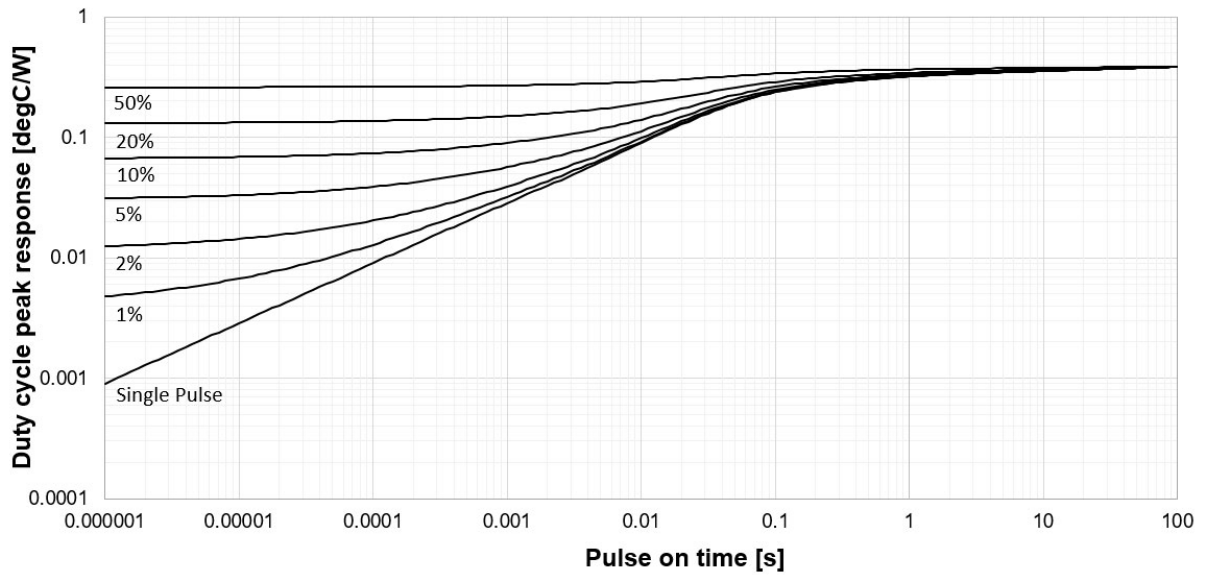

Figure 43. Transient Thermal Impedance – Inverse Diode

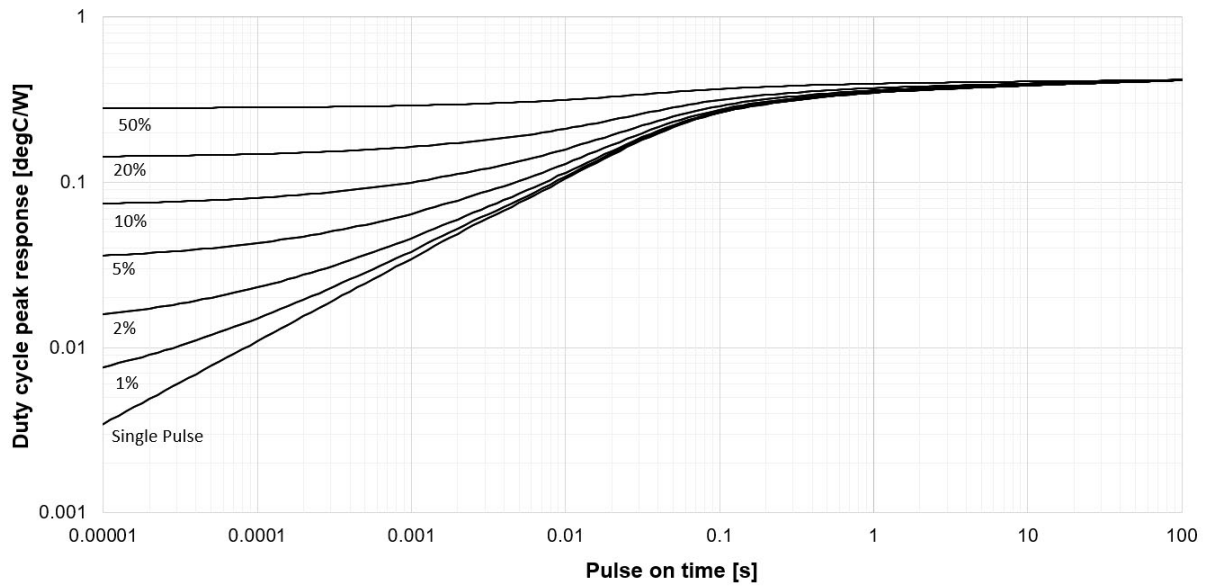

Figure 44. Transient Thermal Impedance – Neutral Point Diode

NXH350N100H4Q2F2

SAFE OPERATING AREA

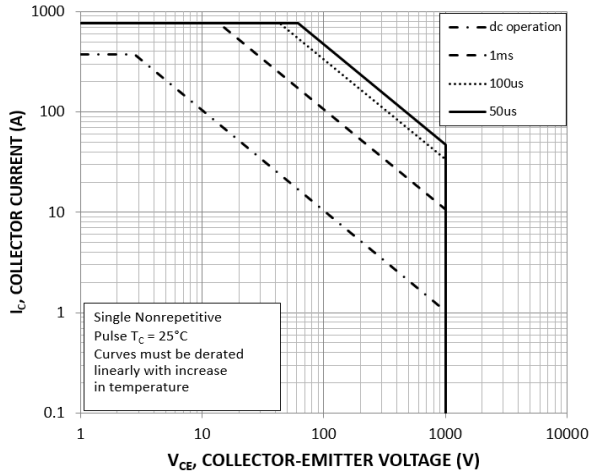

Figure 45. FBSOA – Outer IGBT

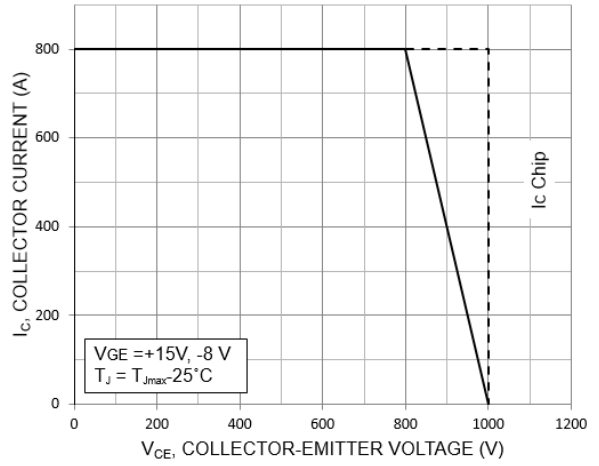

Figure 46. RBSOA – Outer IGBT

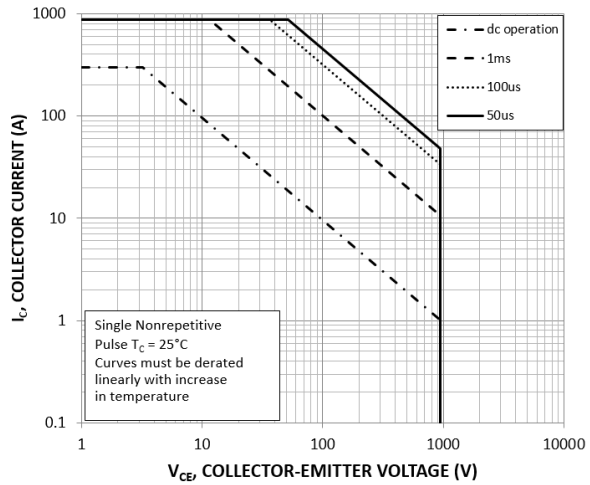

Figure 47. FBSOA – Inner IGBT

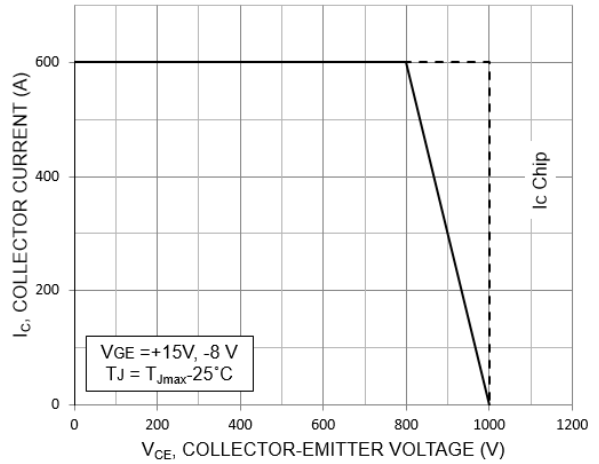

Figure 48. RBSOA – Inner IGBT

NXH350N100H4Q2F2

GATE CHARGE AND CAPACITANCE

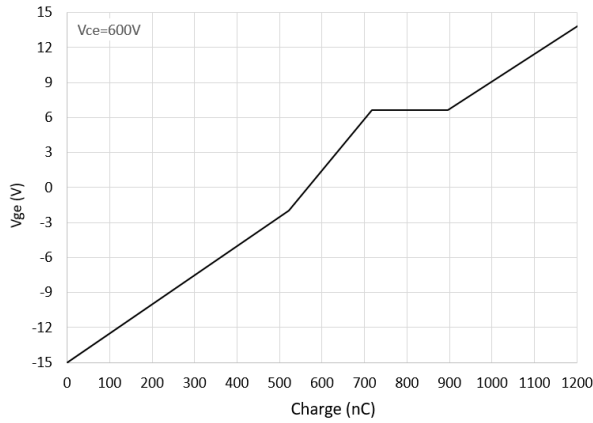

Figure 49. Gate Voltage vs. Gate Charge – Outer IGBT

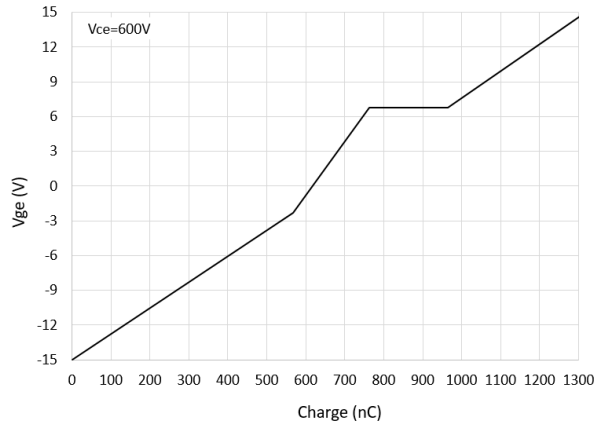

Figure 50. Gate Voltage vs. Gate Charge – Inner IGBT

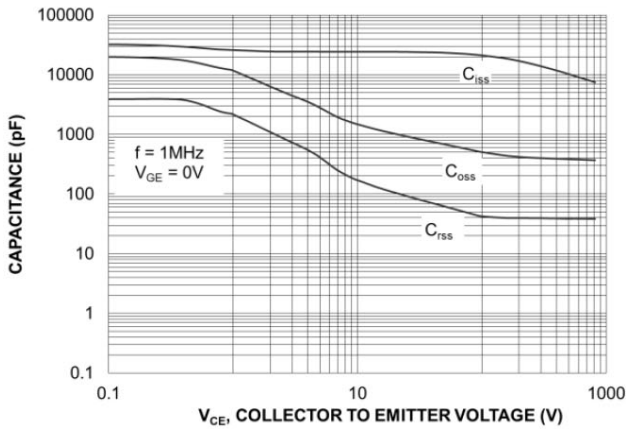

Figure 51. Capacitance Charge – Outer IGBT

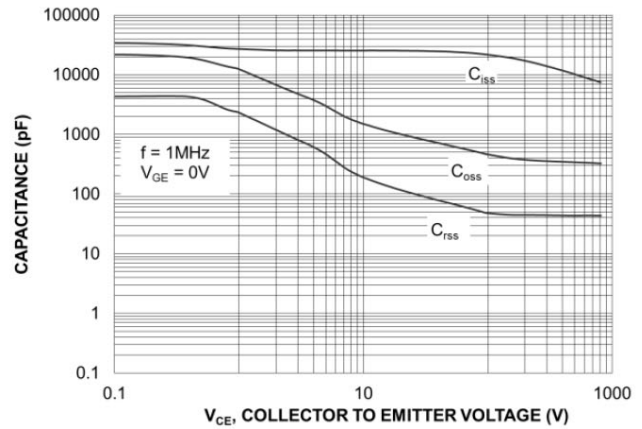

Figure 52. Capacitance Charge – Inner IGBT

TYPICAL CHARACTERISTICS – THERMISTOR

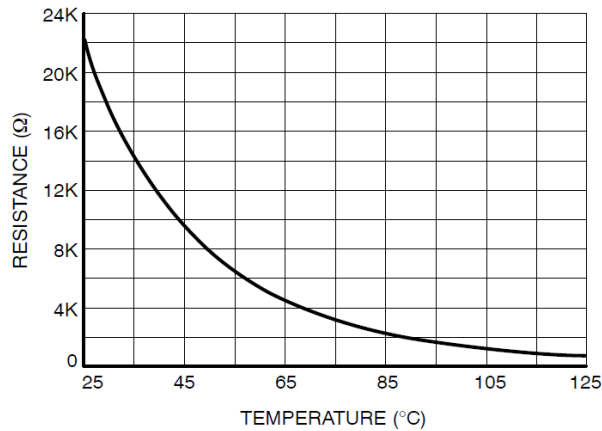

Figure 53. Thermistor Characteristics

MECHANICAL CASE OUTLINE PACKAGE DIMENSIONS



PIM42, 93.00x47.00x12.00
CASE 180BH
ISSUE A

DATE 11 OCT 2023

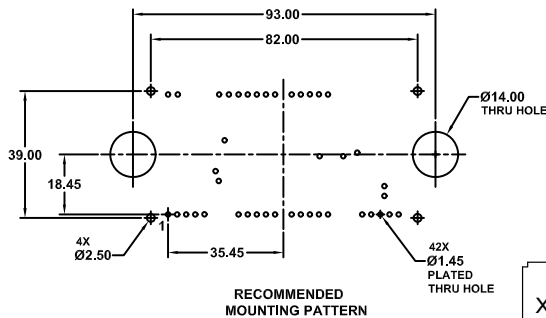
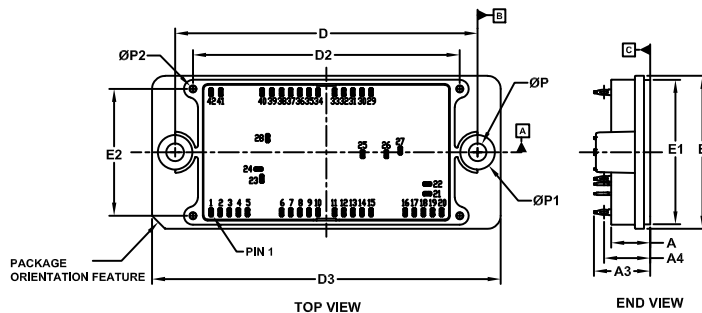
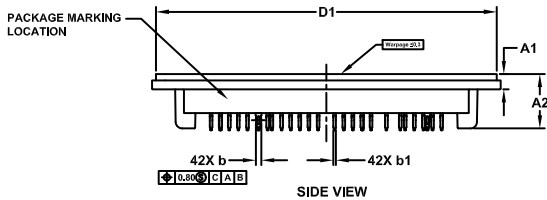
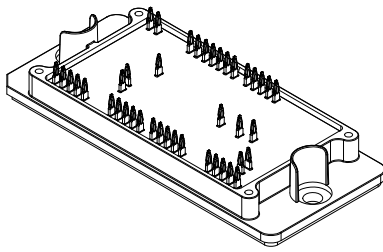

NOTES:

1. DIMENSIONING AND TOLERANCING PER ASME Y14.5M, 2009.
2. CONTROLLING DIMENSION: MILLIMETERS
3. DIMENSIONS b AND b1 APPLY TO THE PLATED TERMINALS AND ARE MEASURED AT DIMENSION A4.
4. POSITION OF THE CENTER OF THE TERMINALS IS DETERMINED FROM DATUM B THE CENTER OF DIMENSION D, X DIRECTION, AND FROM DATUM A, Y DIRECTION. POSITIONAL TOLERANCE, AS NOTED IN DRAWING, APPLIES TO EACH TERMINAL IN BOTH DIRECTIONS.
5. PACKAGE MARKING IS LOCATED AS SHOWN ON THE SIDE OPPOSITE THE PACKAGE ORIENTATION FEATURES.
6. PRESS FIT PIN

DIM	MILLIMETERS		
	MIN.	NOM.	MAX.
A	11.70	12.00	12.30
A1	4.40	4.70	5.00
A2	16.40	16.70	17.00
A3	16.90	17.30	17.70
A4	13.97	14.18	14.39
b	1.61	1.66	1.71
b1	0.75	0.80	0.85
D	92.90	93.00	93.10
D1	104.45	104.75	105.05
D2	81.80	82.00	82.20
D3	106.90	107.20	107.50
E	46.20	47.00	47.80
E1	44.10	44.40	44.70
E2	38.80	39.00	39.10
P	5.40	5.50	5.60
P1	10.60	10.70	10.80
P2	1.80	2.00	2.20

NOTE 4

PIN	PIN POSITION		PIN	PIN POSITION	
	X	Y		X	Y
1	0.00	0.00	22	66.50	8.70
2	2.80	0.00	23	15.60	10.30
3	5.60	0.00	24	14.60	13.30
4	8.40	0.00	25	46.60	17.90
5	11.20	0.00	26	53.90	17.90
6	21.70	0.00	27	58.20	19.00
7	24.50	0.00	28	17.40	22.80
8	27.30	0.00	29	49.20	36.90
9	30.10	0.00	30	46.40	36.90
10	32.90	0.00	31	43.60	36.90
11	38.00	0.00	32	40.80	36.90
12	40.80	0.00	33	38.00	36.90
13	43.60	0.00	34	32.90	36.90
14	46.40	0.00	35	30.10	36.90
15	49.20	0.00	36	27.30	36.90
16	59.70	0.00	37	24.50	36.90
17	62.50	0.00	38	21.70	36.90
18	65.30	0.00	39	18.70	36.90
19	68.10	0.00	40	15.70	36.90
20	70.90	0.00	41	3.00	36.90
21	66.50	5.70	42	0.00	36.90

GENERIC MARKING DIAGRAM*

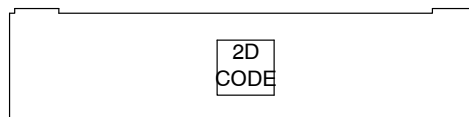
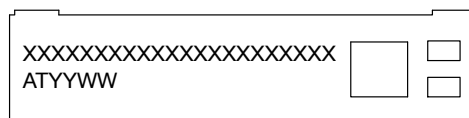

XXXXX = Specific Device Code
AT = Assembly & Test Site Code
YYYYW = Year and Work Week Code

*This information is generic. Please refer to device data sheet for actual part marking. Pb-Free indicator, "G" or microdot "µ", may or may not be present. Some products may not follow the Generic Marking.

DOCUMENT NUMBER:	98AON09951H	Electronic versions are uncontrolled except when accessed directly from the Document Repository. Printed versions are uncontrolled except when stamped "CONTROLLED COPY" in red.
DESCRIPTION:	PIM42 93.00x47.00x12.00	PAGE 1 OF 1

onsemi and ONSEMI are trademarks of Semiconductor Components Industries, LLC dba onsemi or its subsidiaries in the United States and/or other countries. onsemi reserves the right to make changes without further notice to any products herein. onsemi makes no warranty, representation or guarantee regarding the suitability of its products for any particular purpose, nor does onsemi assume any liability arising out of the application or use of any product or circuit, and specifically disclaims any and all liability, including without limitation special, consequential or incidental damages. onsemi does not convey any license under its patent rights nor the rights of others.

MECHANICAL CASE OUTLINE PACKAGE DIMENSIONS



PIM42, 93.00x47.00x12.00
CASE 180BS
ISSUE A

DATE 12 OCT 2023

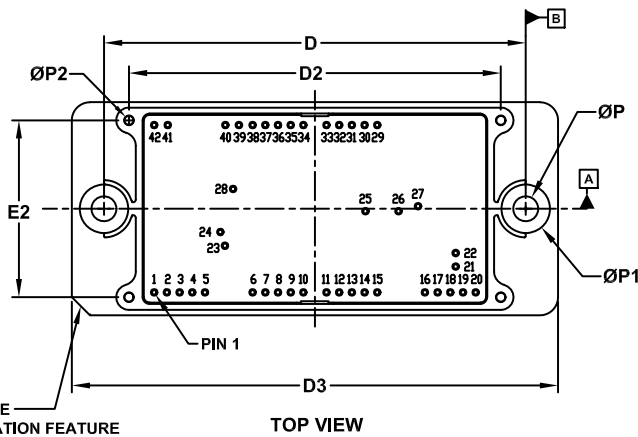
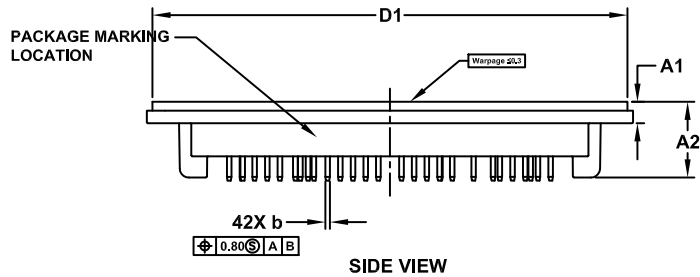
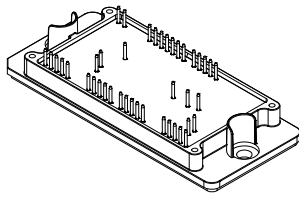

NOTES:

1. DIMENSIONING AND TOLERANCING PER ASME Y14.5M, 2009.
2. CONTROLLING DIMENSION: MILLIMETERS
3. DIMENSIONS b AND b1 APPLY TO THE PLATED TERMINALS AND ARE MEASURED AT DIMENSION A4.
4. POSITION OF THE CENTER OF THE TERMINALS IS DETERMINED FROM DATUM B THE CENTER OF DIMENSION D, X DIRECTION, AND FROM DATUM A, Y DIRECTION. POSITIONAL TOLERANCE, AS NOTED IN DRAWING, APPLIES TO EACH TERMINAL IN BOTH DIRECTIONS.
5. PACKAGE MARKING IS LOCATED AS SHOWN ON THE SIDE OPPOSITE THE PACKAGE ORIENTATION FEATURES.
6. SOLDER PIN

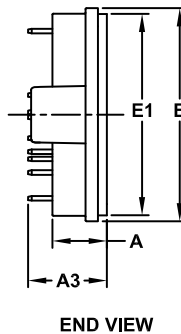

DIM	MILLIMETERS		
	MIN.	NOM.	MAX.
A	11.70	12.00	12.30
A1	4.40	4.70	5.00
A2	16.40	16.70	17.00
A3	16.80	17.20	17.60
b	0.95	1.00	1.05
D	92.90	93.00	93.10
D1	104.45	104.75	105.05
D2	81.80	82.00	82.20
D3	106.90	107.20	107.50
E	46.20	47.00	47.80
E1	44.10	44.40	44.70
E2	38.80	39.00	39.10
P	5.40	5.50	5.60
P1	10.60	10.70	10.80
P2	1.80	2.00	2.20

NOTE 4

PIN	PIN POSITION		PIN	PIN POSITION	
	X	Y		X	Y
1	0.00	0.00	22	66.50	8.70
2	2.80	0.00	23	15.60	10.30
3	5.60	0.00	24	14.60	13.30
4	8.40	0.00	25	46.60	17.90
5	11.20	0.00	26	53.90	17.90
6	21.70	0.00	27	58.20	19.00
7	24.50	0.00	28	17.40	22.80
8	27.30	0.00	29	49.20	36.90
9	30.10	0.00	30	46.40	36.90
10	32.90	0.00	31	43.60	36.90
11	38.00	0.00	32	40.80	36.90
12	40.80	0.00	33	38.00	36.90
13	43.60	0.00	34	32.90	36.90
14	46.40	0.00	35	30.10	36.90
15	49.20	0.00	36	27.30	36.90
16	59.70	0.00	37	24.50	36.90
17	62.50	0.00	38	21.70	36.90
18	65.30	0.00	39	18.70	36.90
19	68.10	0.00	40	15.70	36.90
20	70.90	0.00	41	3.00	36.90
21	66.50	5.70	42	0.00	36.90

GENERIC
MARKING DIAGRAM*

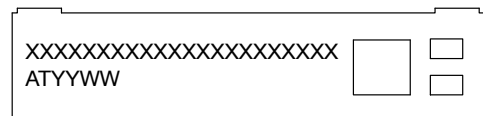

FRONTSIDE MARKING

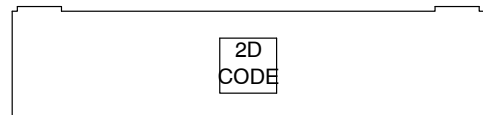

BACKSIDE MARKING

XXXXX = Specific Device Code
AT = Assembly & Test Site Code
YYWW = Year and Work Week Code

*This information is generic. Please refer to device data sheet for actual part marking. Pb-Free indicator, "C" or microdot "▪", may or may not be present. Some products may not follow the Generic Marking.

DOCUMENT NUMBER:	98AON15232H	Electronic versions are uncontrolled except when accessed directly from the Document Repository. Printed versions are uncontrolled except when stamped "CONTROLLED COPY" in red.
DESCRIPTION:	PIM42 93.00x47.00x12.00	PAGE 1 OF 1

onsemi and ONSEMI are trademarks of Semiconductor Components Industries, LLC dba onsemi or its subsidiaries in the United States and/or other countries. onsemi reserves the right to make changes without further notice to any products herein. onsemi makes no warranty, representation or guarantee regarding the suitability of its products for any particular purpose, nor does onsemi assume any liability arising out of the application or use of any product or circuit, and specifically disclaims any and all liability, including without limitation special, consequential or incidental damages. onsemi does not convey any license under its patent rights nor the rights of others.

onsemi, **Onsemi**, and other names, marks, and brands are registered and/or common law trademarks of Semiconductor Components Industries, LLC dba "**onsemi**" or its affiliates and/or subsidiaries in the United States and/or other countries. **onsemi** owns the rights to a number of patents, trademarks, copyrights, trade secrets, and other intellectual property. A listing of **onsemi**'s product/patent coverage may be accessed at www.onsemi.com/site/pdf/Patent-Marking.pdf. **onsemi** reserves the right to make changes at any time to any products or information herein, without notice. The information herein is provided "as-is" and **onsemi** makes no warranty, representation or guarantee regarding the accuracy of the information, product features, availability, functionality, or suitability of its products for any particular purpose, nor does **onsemi** assume any liability arising out of the application or use of any product or circuit, and specifically disclaims any and all liability, including without limitation special, consequential or incidental damages. Buyer is responsible for its products and applications using **onsemi** products, including compliance with all laws, regulations and safety requirements or standards, regardless of any support or applications information provided by **onsemi**. "Typical" parameters which may be provided in **onsemi** data sheets and/or specifications can and do vary in different applications and actual performance may vary over time. All operating parameters, including "Typicals" must be validated for each customer application by customer's technical experts. **onsemi** does not convey any license under any of its intellectual property rights nor the rights of others. **onsemi** products are not designed, intended, or authorized for use as a critical component in life support systems or any FDA Class 3 medical devices or medical devices with a same or similar classification in a foreign jurisdiction or any devices intended for implantation in the human body. Should Buyer purchase or use **onsemi** products for any such unintended or unauthorized application, Buyer shall indemnify and hold **onsemi** and its officers, employees, subsidiaries, affiliates, and distributors harmless against all claims, costs, damages, and expenses, and reasonable attorney fees arising out of, directly or indirectly, any claim of personal injury or death associated with such unintended or unauthorized use, even if such claim alleges that **onsemi** was negligent regarding the design or manufacture of the part. **onsemi** is an Equal Opportunity/Affirmative Action Employer. This literature is subject to all applicable copyright laws and is not for resale in any manner.

ADDITIONAL INFORMATION

TECHNICAL PUBLICATIONS:

Technical Library: www.onsemi.com/design/resources/technical-documentation
onsemi Website: www.onsemi.com

ONLINE SUPPORT: www.onsemi.com/support

For additional information, please contact your local Sales Representative at www.onsemi.com/support/sales