

Single Phase Inverter Automotive Power MOSFET Module

NXV08A170DB2

Features

- Half Bridge Inverter for Variable Speed Motor Drive
- Current Sensing and Temperature Sensing
- Electrically Isolated DBC Substrate for Low Thermal Resistance
- Compact Design for Low Total Module Resistance
- Module Serialization for Full Traceability
- C Snubber for Low EMI
- AQC324 Qualified
- PPAP Capable
- This Device is Pb-free, RoHS and UL94-V0 Compliant

Applications

- 48 V Motor Control

Benefits

- Enable Design of Small, Efficient and Reliable System for Reduced Vehicle Fuel Consumption and CO₂ Emission
- Enable Low Thermal Resistance
- Simplified Vehicle Assembly

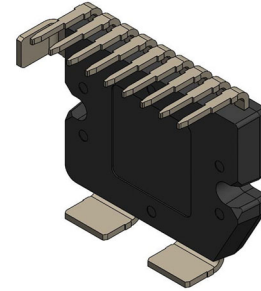

APM12-CBA
 CASE MODBG

MARKING DIAGRAM

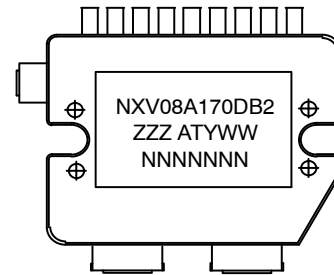

NXV08A170DB2 = Specific Device Code
 ZZZ = Lot ID
 AT = Assembly & Test Location
 Y = Year
 WW = Work Week
 NNN = Serial Number

ORDERING INFORMATION

See detailed ordering and shipping information on page 10 of this data sheet.

NXV08A170DB2

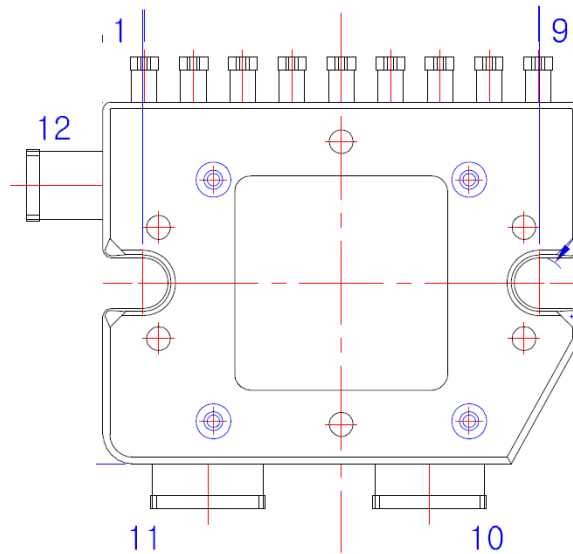

Figure 1. Pin Configuration

PIN DESCRIPTION

Pin Number	Pin Name	Pin Description
1	Q2LG	Low side MOSFET (Q2) Gate
2	Q2LS	Low side MOSFET (Q2) source sense
3	NTC+	Thermistor 1
4	NTC-	Thermistor 2
5	Shunt N	Shunt N
6	Shunt P	Shunt P
7	Q1HS	High side MOSFET (Q1) source sense
8	VLINK	B+ Sense
9	Q1HG	High side MOSFET (Q1) Gate
10	B+	B+ connection
11	GND	GND connection
12	POUT	Phase connection

NXV08A170DB2

Block Diagram

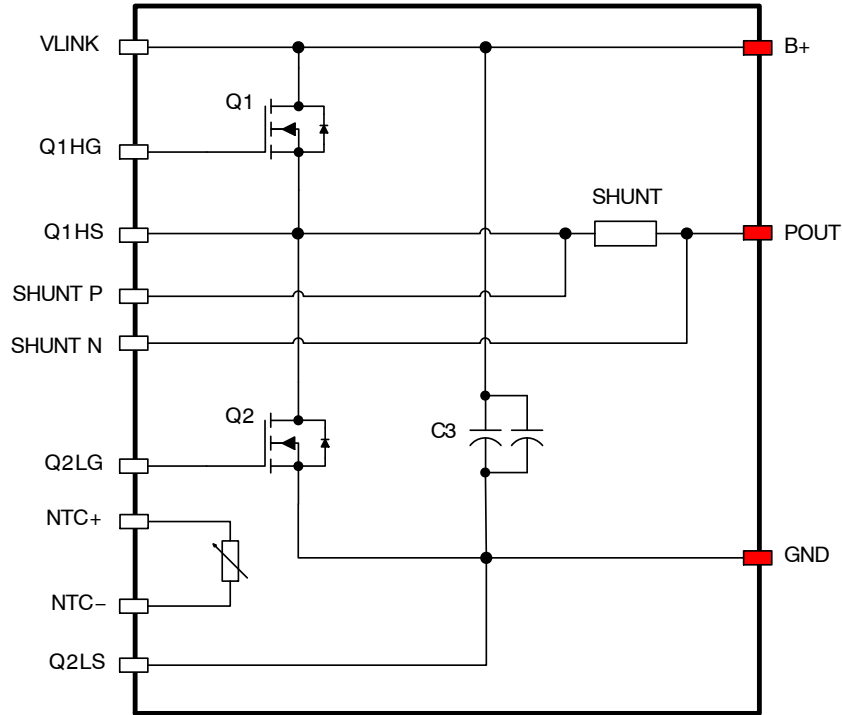

Figure 2. Schematic

Flammability Information

All materials present in the power module meet UL flammability rating class 94V-0.

Solder

Solder used is a lead free SnAgCu alloy.

Compliance to RoHS Directives

The power module is 100% lead free and RoHS compliant 2000/53/C directive.

ABSOLUTE MAXIMUM RATINGS (T_J = 25°C unless otherwise noted)

Symbol	Parameter	Value	Unit
V _{DS}	Drain to Source Voltage	80	V
V _{GS}	Gate to Source Voltage	±20	V
I _D	Drain Current Continuous (Note 1)	200	A
E _{AS}	Single Pulse Avalanche Energy (Note 2)	685	mJ
T _{J(max)}	Maximum Junction Temperature	175	°C
T _{STG}	Storage Temperature Range	-40 ~ +125	°C
V _{ISO}	Isolation Voltage	2000	V _{rms}

Stresses exceeding those listed in the Maximum Ratings table may damage the device. If any of these limits are exceeded, device functionality should not be assumed, damage may occur and reliability may be affected.

1. Defined by design, not subject to production testing. The value is the result of the calculation, Min (package limit max current, Silicon limit max current) where the silicon limit current is calculated based on the maximum value which is not to exceed T_J = 175°C on maximum thermal limitation and on resistance.
2. Starting T_J = 25°C, L = 0.47 mH, I_{AS} = 54 A, V_{DD} = 80 V during inductor charging and V_{DD} = 0 V during time in avalanche.

NXV08A170DB2

THERMAL CHARACTERISTICS

Symbol	Parameter	Min	Typ	Max	Unit
$R_{\theta JC}$	Thermal Resistance, Junction-to-Case (Note 3)	-	-	0.82	K/W

3. Test method compliant with MIL-STD-883-1012.1, case temperature measured below the package at the chip center. Cosmetic oxidation and discolor on the DBC surface is allowed.

ELECTRICAL CHARACTERISTICS ($T_J = 25^\circ\text{C}$ unless otherwise noted)

Parameters	Test Conditions	Symbol	Min	Typ	Max	Unit
Drain-to-Source Breakdown Voltage	$I_D = 250 \mu\text{A}$, $V_{GS} = 0 \text{ V}$	B_{VDSS}	80	-	-	V
Drain-to-Source Leakage Current	$V_{DS} = 80 \text{ V}$, $V_{GS} = 0 \text{ V}$	I_{DSS}	-	-	1	μA
Gate-to-Source Leakage Current	$V_{GS} = \pm 20 \text{ V}$	I_{GSS}	-	-	± 100	nA
Gate-to-Source Threshold Voltage	$V_{GS} = V_{DS}$, $I_D = 250 \mu\text{A}$	$V_{GS(th)}$	2.0	-	4.0	V
Body Diode Forward Voltage of MOSFET	$I_{SD} = 80 \text{ A}$, $V_{GS} = 0 \text{ V}$	V_{SD}	-	0.8	1.2	V
Drain-to-Source On Resistance, Q1	$I_D = 80 \text{ A}$, $V_{GS} = 10 \text{ V}$ (Note 4)	$R_{DS(ON)Q1}$	-	0.66	0.99	$\text{m}\Omega$
Drain-to-Source On Resistance, Q2		$R_{DS(ON)Q2}$	-	0.90	1.35	$\text{m}\Omega$
Drain-to-Source On Resistance, Module Level Q1		$R_{DS(ON) \text{ Module Q1}}$	-	1.75	2.40	$\text{m}\Omega$
Drain-to-Source On Resistance, Module Level Q2		$R_{DS(ON) \text{ Module Q2}}$	-	1.75	2.40	$\text{m}\Omega$

4. All bare die MOSFETs have same die size and same level of $R_{DS(ON)}$ value. However the different $R_{DS(ON)}$ values listed in the datasheet are due to the different access points available inside the module for $R_{DS(ON)}$ measurement. Q1 (High side FET) has shorter $R_{DS(ON)}$ measurement path in the layout, in this reason, $R_{DS(ON)}$ value of Q1 can be used for simple power loss calculation.

Resistance Measurements Methods

MOSFET MEASUREMENTS

	+ Force	- Force	+ Sense	- Sense		+ Force	- Force	+ Sense	- Sense
Q1	B+	Phase	Vlink	Q1 Sorce	Q2	Phase	GND	Q1 Source	Q2 Source
PIN#	9	11	8	5	PIN#	11	10	5	2

MODULE PATH MEASUREMENTS

	+ Force	- Force	+ Sense	- Sense		+ Force	- Force	+ Sense	- Sense
Q1	B+	Phase	B+	Phase	Q2	Phase	GND	Phase	GND
PIN#	9	11	9	11	PIN#	11	10	11	10

CURRENT SENSE RESISTOR

Symbol	Parameter	Min	Typ	Max	Unit
R_{SHUNT}	Current Sense Resistor, $I_d = 80 \text{ A}$ (Note 5)	0.293	0.304	0.317	$\text{m}\Omega$

5. Except resistance value, all the other characteristic is guaranteed by supplier.

COMPONENTS

Component	Specification	Quantity	Type
MOSFET	80 V Bare die reference discrete part, FDBL86361_F085	2	Bare Die
Current Sense Resistor	0.3 $\text{m}\Omega$	1	Discrete
Capacitor	DC 100 V, 68000 pF	2	Discrete
NTC	10 $\text{k}\Omega$	1	Discrete

NXV08A170DB2

ELECTRICAL CHARACTERISTICS (T_J = 25°C unless otherwise noted)

Parameter	Symbol	Test Condition	Min	Typ	Max	Unit
OFF CHARACTERISTICS						
Input Capacitance	C _{iss}	V _{DS} = 40 V, V _{GS} = 0 V, f = 1 MHz	–	14000	–	pF
Output Capacitance	C _{oss}		–	9450	–	pF
Reverse Transfer Capacitance	C _{rss}		–	100	–	pF
Gate Resistance	R _g	f = 1 MHz	–	2.9	–	Ω
Total Gate Charge	Q _{g(tot)}	V _{GS} = 0 V to 10 V	–	195	–	nC
Threshold Gate Charge	Q _{g(th)}	V _{GS} = 0 V to 2.7 V				
Gate to Source Gate Charge	Q _{gs}	V _{DD} = 64 V, I _D = 80 A	–	66	–	nC
Gate to Drain “Miller” Charge	Q _{gd}		–	45	–	nC
ON CHARACTERISTICS						
Turn-On Time	t _{on}	V _{DD} = 48 V, I _D = 80 A V _{GS} = 10 V, R _{GEN} = 6 Ω (Note 6)	–	250	–	ns
Turn-On Delay Time	t _{d(on)}		–	65	–	ns
Turn-On Rise Time	t _r		–	184	–	ns
Turn-Off Delay Time	t _{d(off)}		–	153	–	ns
Turn-Off Fall Time	t _f		–	123	–	ns
Turn-Off Time	t _{off}		–	276	–	ns
BODY DIODE CHARACTERISTICS						
Reverse Recovery Time	T _{rr}	V _{SD} = 64 V, I _{SD} = 125 A, dI/dt = 100 A/μs	–	112	–	ns
Reverse Recovery Charge	Q _{rr}		–	208	–	nC

Product parametric performance is indicated in the Electrical Characteristics for the listed test conditions, unless otherwise noted. Product performance may not be indicated by the Electrical Characteristics if operated under different conditions.

6. By characterization, the measurement is limited by test set up.

TYPICAL CHARACTERISTICS

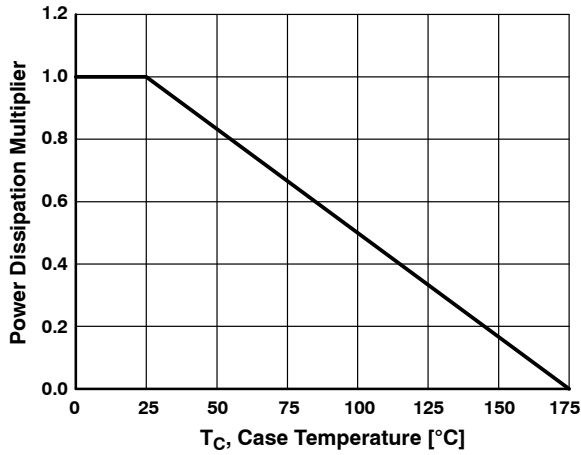

Figure 3. Normalized Power Dissipation vs. Case Temperature

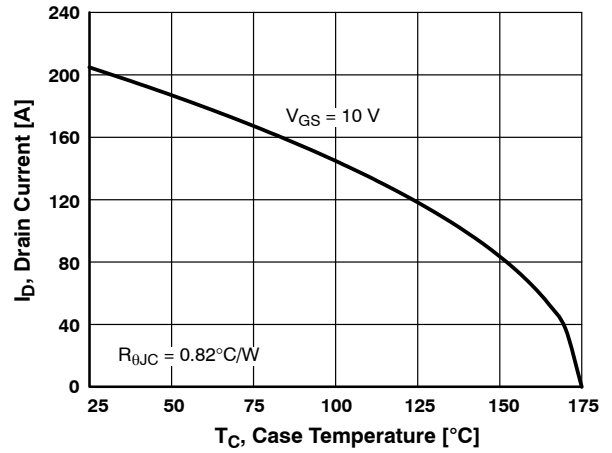

Figure 4. Maximum Continuous Drain Current vs. Case Temperature

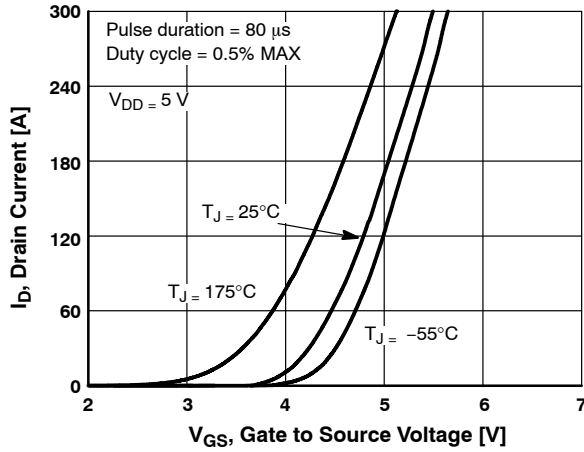

Figure 5. Transfer Characteristics

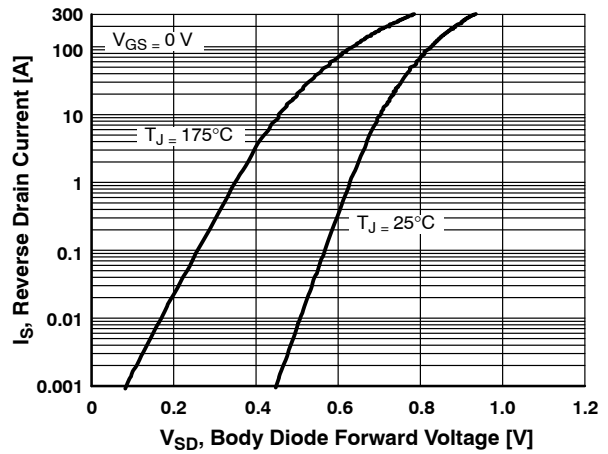

Figure 6. Forward Diode Characteristics

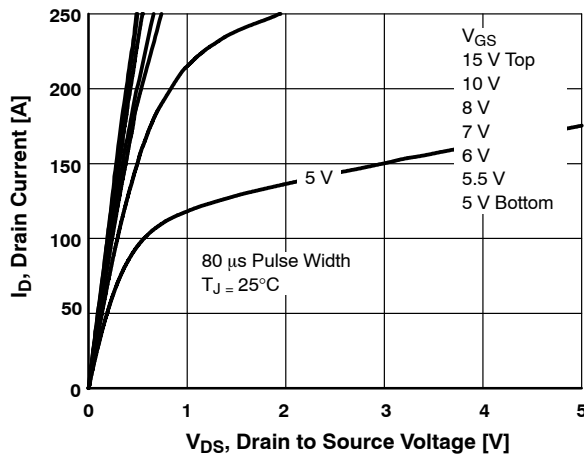

Figure 7. Saturation Characteristics (25°C)

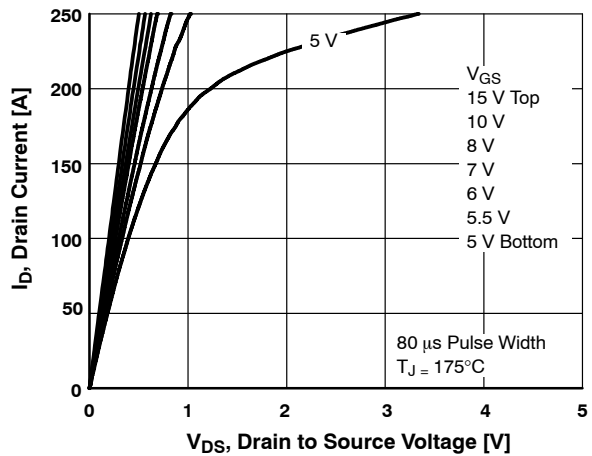

Figure 8. Saturation Characteristics (175°C)

TYPICAL CHARACTERISTICS (continued)

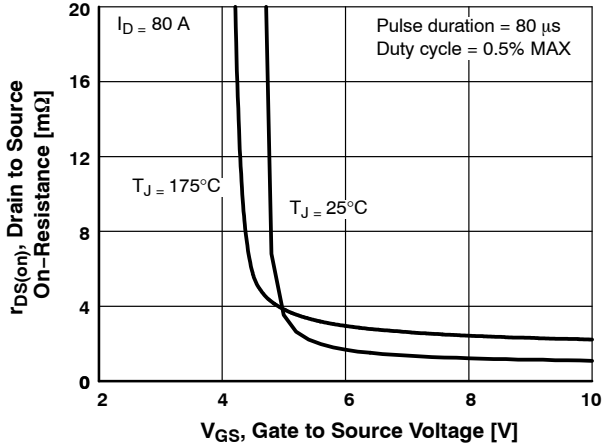

Figure 9. $R_{DS(on)}$ vs. Gate Voltage

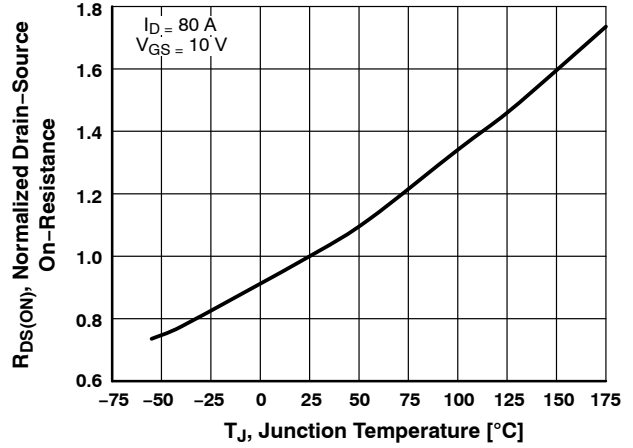

Figure 10. Normalized $R_{DS(on)}$ vs. Junction Temperature

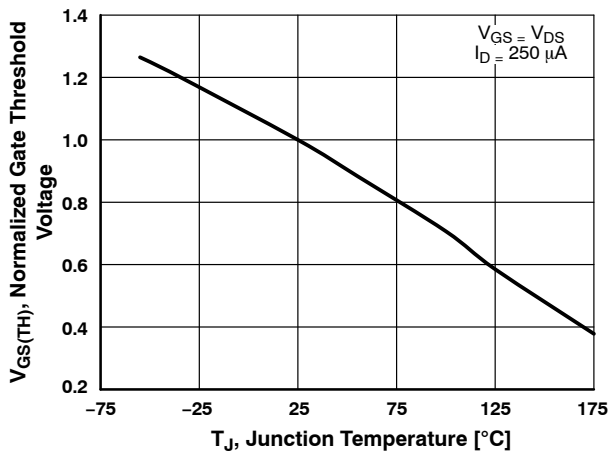

Figure 11. Normalized $V_{GS(th)}$ vs. Temperature

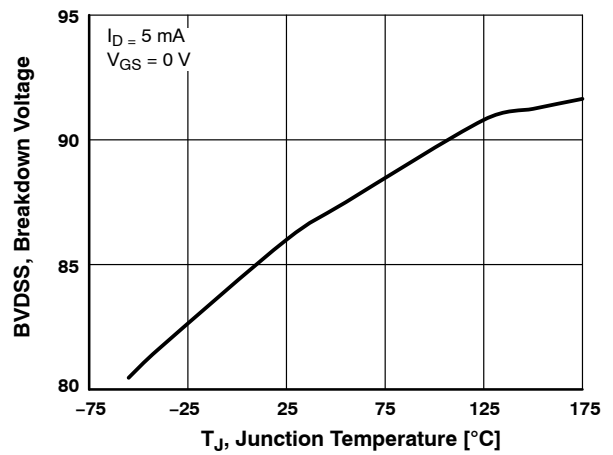

Figure 12. Breakdown Voltage vs. Temperature

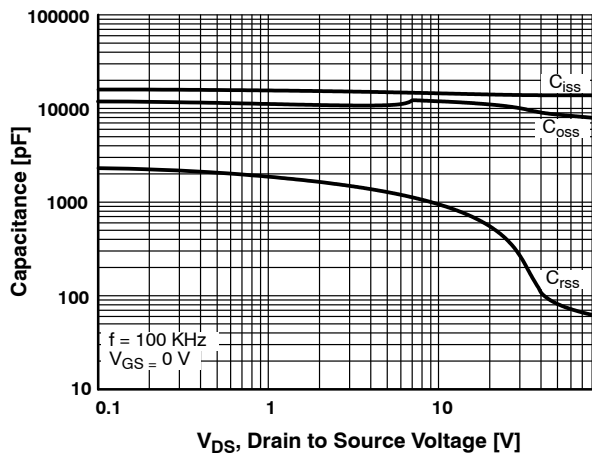

Figure 13. Capacitance Variation

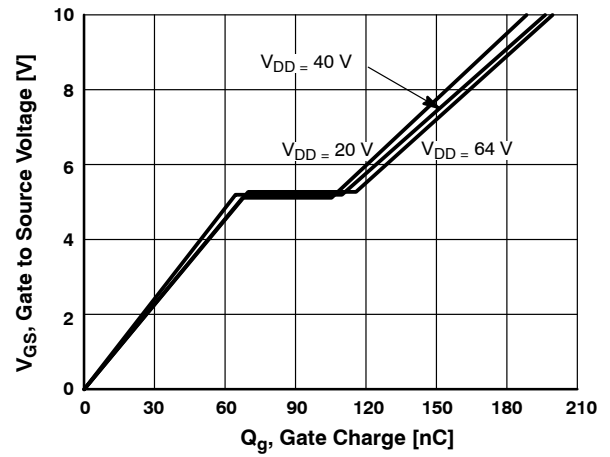
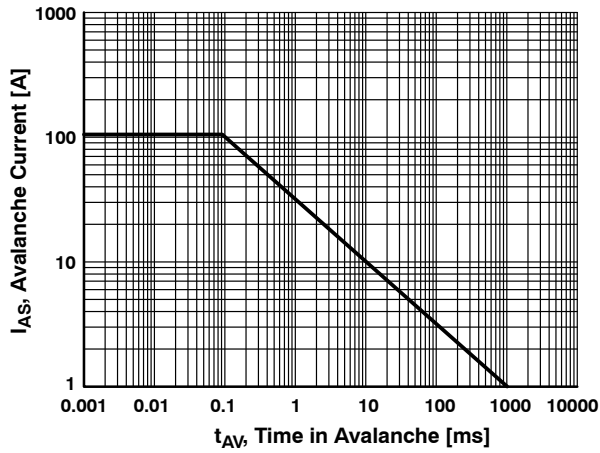

Figure 14. Gate Charge

TYPICAL CHARACTERISTICS (continued)



Refer to onsemi Application Notes AN7514 and AN7515.

Figure 15. Unclamped Inductive Switching Capability

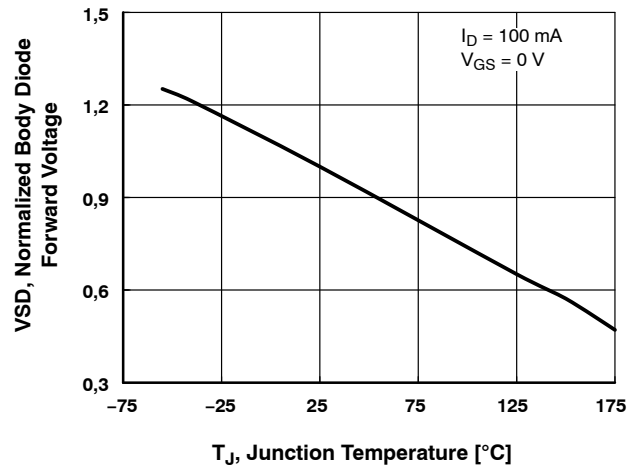

Figure 16. Forward Diode Characteristic

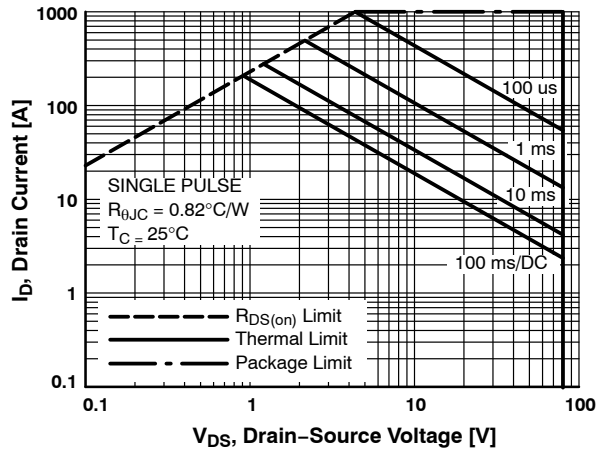

Figure 17. Safe Operation Area

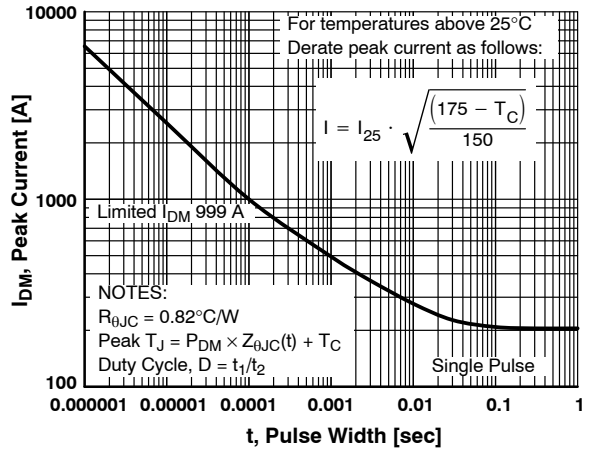

Figure 18. Peak Current Capability

TYPICAL CHARACTERISTICS (continued)

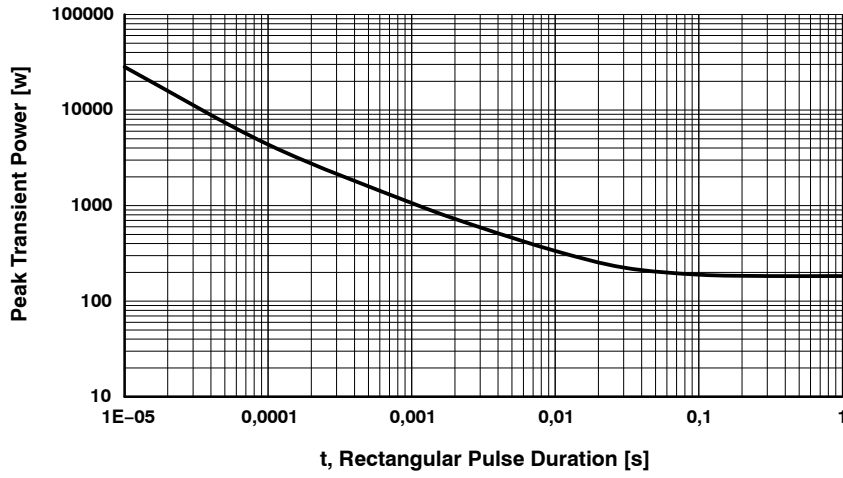

Figure 19. Peak Power Capability

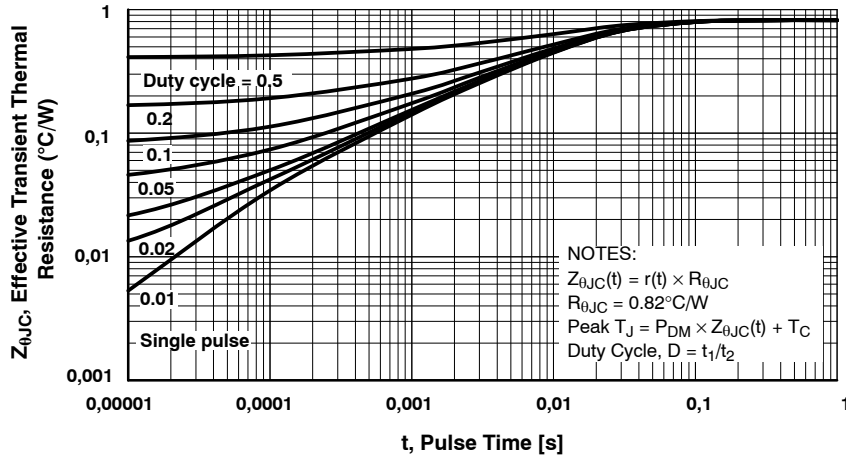
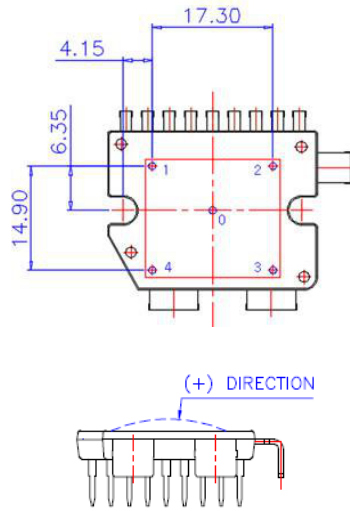

Figure 20. Maximum Transient Thermal Impedance

NXV08A170DB2

PACKAGE DIMENSIONS



- 1.WARPAGE SPEC: 0 ~ 100um
 2.WARPAGE MEASUREMENT
 1)OPTICAL HEIGHT MEASUREMENT ZERO POINT
 IN PACKAGE CENTER
 2)WARPAGE IN MAX HEIGHT OF POINT 1,2,3,4

Figure 21. Flatness Measurement Position

MECHANICAL CHARACTERISTICS AND RATINGS

Parameter	Test Conditions	Min	Typ	Max	Units
Device Flatness	Refer to the package dimensions	0	-	100	um
Mounting Torque	Mounting screw – M3, Recommended 0.7 N-m	0.6	-	1.4	N-m
Weight		-	10	-	g
Compression Test	Maximum load, test speed: 0.5 mm/min (Note 7)	-	-	22	kN

7. Guaranteed by experiment, valid only in confirmed condition.

PACKAGE MARKING AND ORDERING INFORMATION

Device	Part Number	Package	Pb-Free and RoHS Compliant	Packing Method
NXV08A170DB2	NXV08A170DB2	APM12-CBA	Yes	Tray

MECHANICAL CASE OUTLINE

PACKAGE DIMENSIONS

ON Semiconductor®

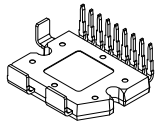

APM12-SERIES AUTOMOTIVE MODULE

CASE MODBG

ISSUE B

DATE 16 DEC 2021

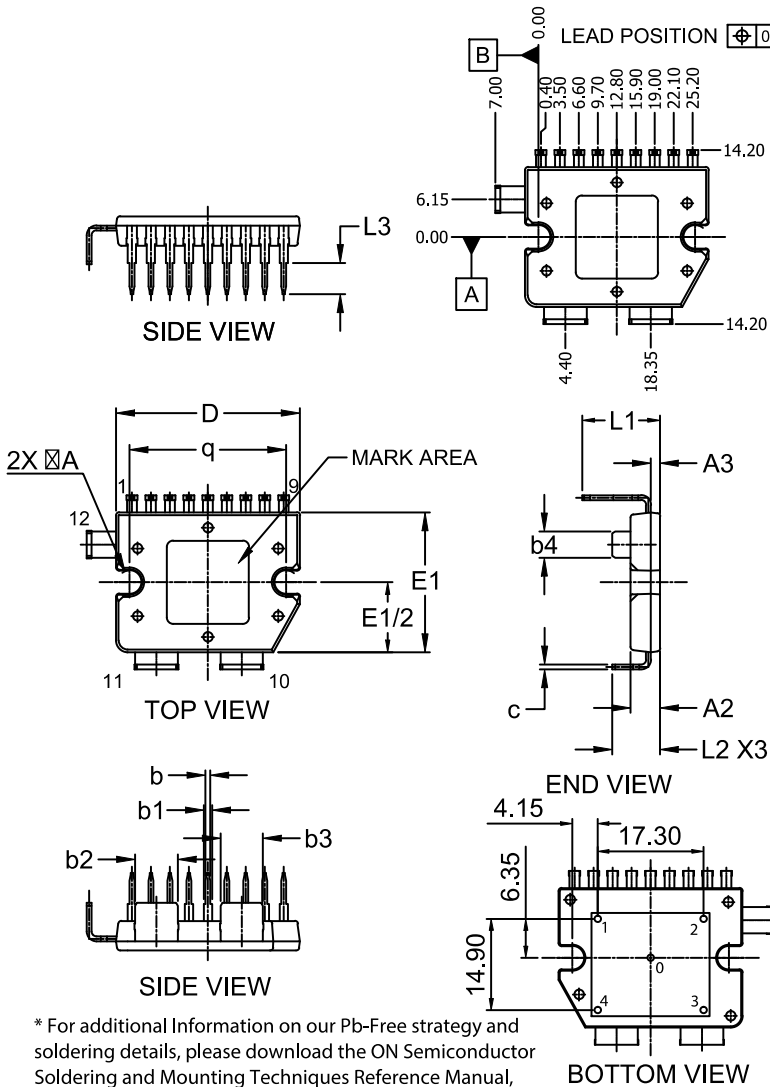

NOTES:

1. DIMENSIONING AND TOLERANCING PER. ASME Y14.5M, 2009.
2. CONTROLLING DIMENSION: MILLIMETERS.
3. DIMENSIONS ARE EXCLUSIVE OF BURRS, MOLD FLASH AND TIE BAR EXTRUSIONS.

DIM	MILLIMETERS		
	MIN.	NOM.	MAX.
⊠A	3.70	3.80	3.90
A2	4.60	4.80	5.00
A3	1.30	1.50	1.70
b	0.70	0.80	0.90
b1	1.25	1.35	1.45
b2	6.80	7.00	7.20
b3	6.70	6.90	7.10
b4	4.10	4.30	4.50
c	0.75	0.80	0.85
D	29.80	30.00	30.20
E1	22.60	22.80	23.00
L1	12.40	12.70	13.00
L2	7.50	7.80	8.10
L3	4.90	5.10	5.30
q	25.50	25.60	25.70

* For additional Information on our Pb-Free strategy and soldering details, please download the ON Semiconductor Soldering and Mounting Techniques Reference Manual, SOLDER RM/D.

* WARPAGE (POINT 1,2,3,4 BASED ON 0)
: 0~100um

GENERIC MARKING DIAGRAM*

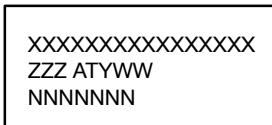

XXXX = Specific Device Code
 ZZZ = Lot ID
 AT = Assembly & Test Location
 Y = Year
 WW = Work Week
 NNN = Serial Number

*This information is generic. Please refer to device data sheet for actual part marking. Pb-Free indicator, "G" or microdot "μ", may or may not be present. Some products may not follow the Generic Marking.

DOCUMENT NUMBER:	98AON34474H	Electronic versions are uncontrolled except when accessed directly from the Document Repository. Printed versions are uncontrolled except when stamped "CONTROLLED COPY" in red.
DESCRIPTION:	APM12-SERIES AUTOMOTIVE MODULE	PAGE 1 OF 1

ON Semiconductor and are trademarks of Semiconductor Components Industries, LLC dba ON Semiconductor or its subsidiaries in the United States and/or other countries. ON Semiconductor reserves the right to make changes without further notice to any products herein. ON Semiconductor makes no warranty, representation or guarantee regarding the suitability of its products for any particular purpose, nor does ON Semiconductor assume any liability arising out of the application or use of any product or circuit, and specifically disclaims any and all liability, including without limitation special, consequential or incidental damages. ON Semiconductor does not convey any license under its patent rights nor the rights of others.

onsemi, **Onsemi**, and other names, marks, and brands are registered and/or common law trademarks of Semiconductor Components Industries, LLC dba "**onsemi**" or its affiliates and/or subsidiaries in the United States and/or other countries. **onsemi** owns the rights to a number of patents, trademarks, copyrights, trade secrets, and other intellectual property. A listing of **onsemi**'s product/patent coverage may be accessed at www.onsemi.com/site/pdf/Patent-Marking.pdf. **onsemi** reserves the right to make changes at any time to any products or information herein, without notice. The information herein is provided "as-is" and **onsemi** makes no warranty, representation or guarantee regarding the accuracy of the information, product features, availability, functionality, or suitability of its products for any particular purpose, nor does **onsemi** assume any liability arising out of the application or use of any product or circuit, and specifically disclaims any and all liability, including without limitation special, consequential or incidental damages. Buyer is responsible for its products and applications using **onsemi** products, including compliance with all laws, regulations and safety requirements or standards, regardless of any support or applications information provided by **onsemi**. "Typical" parameters which may be provided in **onsemi** data sheets and/or specifications can and do vary in different applications and actual performance may vary over time. All operating parameters, including "Typicals" must be validated for each customer application by customer's technical experts. **onsemi** does not convey any license under any of its intellectual property rights nor the rights of others. **onsemi** products are not designed, intended, or authorized for use as a critical component in life support systems or any FDA Class 3 medical devices or medical devices with a same or similar classification in a foreign jurisdiction or any devices intended for implantation in the human body. Should Buyer purchase or use **onsemi** products for any such unintended or unauthorized application, Buyer shall indemnify and hold **onsemi** and its officers, employees, subsidiaries, affiliates, and distributors harmless against all claims, costs, damages, and expenses, and reasonable attorney fees arising out of, directly or indirectly, any claim of personal injury or death associated with such unintended or unauthorized use, even if such claim alleges that **onsemi** was negligent regarding the design or manufacture of the part. **onsemi** is an Equal Opportunity/Affirmative Action Employer. This literature is subject to all applicable copyright laws and is not for resale in any manner.

ADDITIONAL INFORMATION

TECHNICAL PUBLICATIONS:

Technical Library: www.onsemi.com/design/resources/technical-documentation
onsemi Website: www.onsemi.com

ONLINE SUPPORT: www.onsemi.com/support

For additional information, please contact your local Sales Representative at www.onsemi.com/support/sales