

NXH80B120L2Q0

Q0 - Dual Boost Power Module

The NXH80B120L2Q0 is a high-density, integrated power module combines high-performance IGBTs with rugged anti-parallel diodes including on-board thermistor.

Features

- Dual Boost 40 A / 1200 V IGBT and Si FRD Module
- 1200 V FSII IGBT $V_{CE(SAT)} = 2.2\text{ V}$
- 1200 V Stealth Fast Recovery Diode $V_F = 2.4\text{ V}$
- Low Inductive Layout
- Solderable Pins
- Thermistor
- Bare Copper and Nickel-Plated DBC Options

Typical Applications

- Solar Inverter
- Uninterruptible Power Supplies
- Energy Storage Systems

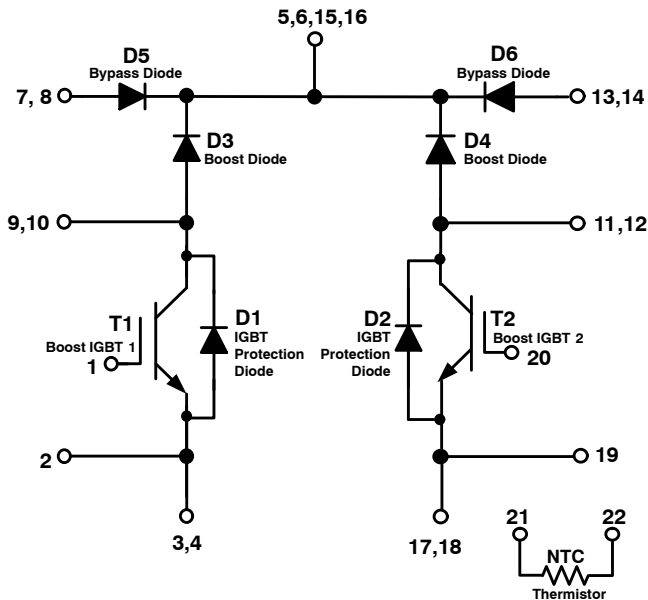
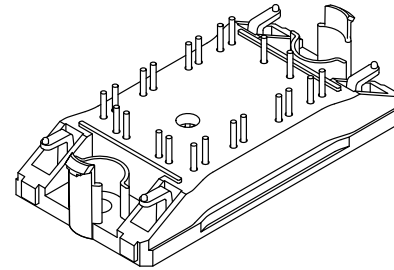

Figure 1. NXH80B120L2Q0SNG Schematic Diagram



ON Semiconductor®

www.onsemi.com



Q0BOOST
CASE 180AJ

MARKING DIAGRAM

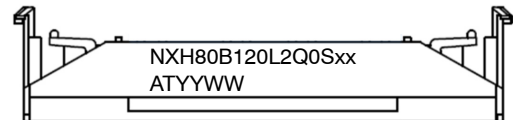

NXH80B120L2Q0Sxx = Specific Device Code
AT = Assembly & Test Side Code
YYWW = Year and Work Week Code

PIN CONNECTIONS

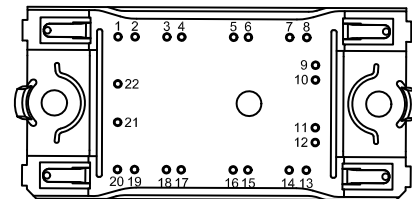

ORDERING INFORMATION

See detailed ordering, marking and shipping information on page 4 of this data sheet.

NXH80B120L2Q0

Table 1. ABSOLUTE MAXIMUM RATINGS (Note 1) $T_J = 25^\circ\text{C}$ unless otherwise noted

Rating	Symbol	Value	Unit
BOOST IGBT			
Collector–Emitter Voltage	V_{CES}	1200	V
Gate–Emitter Voltage	V_{GE}	± 20	V
Continuous Collector Current @ $T_h = 80^\circ\text{C}$ ($T_J = 175^\circ\text{C}$)	I_C	41	A
Pulsed Collector Current ($T_J = 175^\circ\text{C}$)	I_{Cpulse}	123	A
Maximum Power Dissipation ($T_J = 175^\circ\text{C}$)	P_{tot}	103	W
Short Circuit Withstand Time @ $V_{GE} = 15\text{ V}$, $V_{CE} = 600\text{ V}$, $T_J \leq 150^\circ\text{C}$	T_{sc}	5	μs
Minimum Operating Junction Temperature	T_{JMIN}	-40	$^\circ\text{C}$
Maximum Operating Junction Temperature	T_{JMAX}	150	$^\circ\text{C}$

BOOST DIODE			
Peak Repetitive Reverse Voltage	V_{RRM}	1200	V
Continuous Forward Current @ $T_h = 80^\circ\text{C}$ ($T_J = 175^\circ\text{C}$)	I_F	25	A
Maximum Power Dissipation ($T_J = 175^\circ\text{C}$)	P_{tot}	60	W
Surge Forward Current (60 Hz single half–sine wave)	I_{FSM}	150	A
I^2t – value (60 Hz single half–sine wave)	I^2t	93	A^2s
Minimum Operating Junction Temperature	T_{JMIN}	-40	$^\circ\text{C}$
Maximum Operating Junction Temperature	T_{JMAX}	150	$^\circ\text{C}$

BYPASS DIODE / IGBT PROTECTION DIODE			
Peak Repetitive Reverse Voltage	V_{RRM}	1600	V
Continuous Forward Current @ $T_c = 80^\circ\text{C}$ ($T_J = 150^\circ\text{C}$)	I_F	46	A
Repetitive Peak Forward Current ($T_J = 175^\circ\text{C}$, t_p limited by T_{Jmax})	I_{FRM}	130	A
Power Dissipation Per Diode ($T_J = 175^\circ\text{C}$)	P_{tot}	66	W
Minimum Operating Junction Temperature	T_{JMIN}	-40	$^\circ\text{C}$
Maximum Operating Junction Temperature	T_{JMAX}	150	$^\circ\text{C}$

THERMAL PROPERTIES

Storage Temperature range	T_{stg}	-40 to 125	$^\circ\text{C}$
---------------------------	-----------	------------	------------------

INSULATION PROPERTIES

Isolation test voltage, $t = 1\text{ sec}$, 60 Hz	V_{is}	3000	V_{RMS}
Creepage distance		12.7	mm

Stresses exceeding those listed in the Maximum Ratings table may damage the device. If any of these limits are exceeded, device functionality should not be assumed, damage may occur and reliability may be affected.

1. Refer to ELECTRICAL CHARACTERISTICS, RECOMMENDED OPERATING RANGES and/or APPLICATION INFORMATION for Safe Operating parameters.

Table 2. RECOMMENDED OPERATING RANGES

Rating	Symbol	Min	Max	Unit
Module Operating Junction Temperature	T_J	-40	($T_{Jmax} - 25$)	$^\circ\text{C}$

Functional operation above the stresses listed in the Recommended Operating Ranges is not implied. Extended exposure to stresses beyond the Recommended Operating Ranges limits may affect device reliability.

NXH80B120L2Q0

Table 3. ELECTRICAL CHARACTERISTICS $T_J = 25^\circ\text{C}$ unless otherwise noted

Parameter	Test Conditions	Symbol	Min	Typ	Max	Unit
BOOST IGBT CHARACTERISTICS						
Collector-Emitter Cutoff Current	$V_{GE} = 0\text{ V}, V_{CE} = 1200\text{ V}$	I_{CES}	–	–	200	μA
Collector-Emitter Saturation Voltage	$V_{GE} = 15\text{ V}, I_C = 40\text{ A}, T_J = 25^\circ\text{C}$	$V_{CE(sat)}$	–	2.20	2.5	V
	$V_{GE} = 15\text{ V}, I_C = 40\text{ A}, T_J = 150^\circ\text{C}$		–	2.16	–	
Gate-Emitter Threshold Voltage	$V_{GE} = V_{CE}, I_C = 1.5\text{ mA}$	$V_{GE(TH)}$	–	5.45	6.4	V
Gate Leakage Current	$V_{GE} = 20\text{ V}, V_{CE} = 0\text{ V}$	I_{GES}	–	–	200	nA
Turn-on Delay Time	$T_J = 25^\circ\text{C}$ $V_{CE} = 700\text{ V}, I_C = 40\text{ A}$ $V_{GE} = \pm 15\text{ V}, R_G = 4\ \Omega$	$t_{d(on)}$	–	27	–	ns
Rise Time		t_r	–	20	–	
Turn-off Delay Time		$t_{d(off)}$	–	95	–	
Fall Time		t_f	–	75	–	
Turn-on Switching Loss per Pulse		E_{on}	–	1020	–	
Turn off Switching Loss per Pulse	E_{off}	–	1810	–		
Turn-on Delay Time	$T_J = 125^\circ\text{C}$ $V_{CE} = 700\text{ V}, I_C = 40\text{ A}$ $V_{GE} = \pm 15\text{ V}, R_G = 4\ \Omega$	$t_{d(on)}$	–	27	–	ns
Rise Time		t_r	–	20	–	
Turn-off Delay Time		$t_{d(off)}$	–	110	–	
Fall Time		t_f	–	180	–	
Turn-on Switching Loss per Pulse		E_{on}	–	1630	–	
Turn off Switching Loss per Pulse	E_{off}	–	3550	–		
Input Capacitance	$V_{CE} = 25\text{ V}, V_{GE} = 0\text{ V}, f = 10\text{ kHz}$	C_{ies}	–	9700	–	pF
Output Capacitance		C_{oes}	–	200	–	
Reverse Transfer Capacitance		C_{res}	–	170	–	
Total Gate Charge	$V_{CE} = 600\text{ V}, I_C = 40\text{ A}, V_{GE} = 15\text{ V}$	Q_g	–	400	–	nC
Thermal Resistance – chip-to-heatsink	Thermal grease, Thickness < 100 μm , $\lambda = 0.84\text{ W/mK}$	R_{thJH}	–	0.92	–	$^\circ\text{C/W}$

BOOST DIODE CHARACTERISTICS

Diode Reverse Leakage Current	$V_R = 1200\text{ V}$	I_R	–	–	100	μA
Diode Forward Voltage	$I_F = 30\text{ A}, T_J = 25^\circ\text{C}$	V_F	–	2.4	3.15	V
	$I_F = 30\text{ A}, T_J = 150^\circ\text{C}$		–	1.9	–	
Reverse Recovery Time	$T_J = 25^\circ\text{C}$ $V_{CE} = 700\text{ V}, I_C = 40\text{ A}$ $V_{GE} = \pm 15\text{ V}, R_G = 4\ \Omega$	t_{rr}	–	195	–	ns
Reverse Recovery Charge		Q_{rr}	–	2420	–	nC
Peak Reverse Recovery Current		I_{RRM}	–	53	–	A
Peak Rate of Fall of Recovery Current		di/dt	–	2390	–	A/ μs
Reverse Recovery Energy		E_{rr}	–	1360	–	μJ
Reverse Recovery Time	$T_J = 125^\circ\text{C}$ $V_{CE} = 700\text{ V}, I_C = 40\text{ A}$ $V_{GE} = \pm 15\text{ V}, R_G = 4\ \Omega$	t_{rr}	–	370	–	ns
Reverse Recovery Charge		Q_{rr}	–	5580	–	nC
Peak Reverse Recovery Current		I_{RRM}	–	75	–	A
Peak Rate of Fall of Recovery Current		di/dt	–	2025	–	A/ μs
Reverse Recovery Energy		E_{rr}	–	3160	–	μJ
Thermal Resistance – chip-to-heatsink	Thermal grease, Thickness < 100 μm , $\lambda = 0.84\text{ W/mK}$	R_{thJH}	–	1.59	–	$^\circ\text{C/W}$

BYPASS DIODE/IGBT PROTECTION DIODE CHARACTERISTICS

Diode Reverse Leakage Current	$V_R = 1600\text{ V}, T_J = 25^\circ\text{C}$	I_R	–	–	100	μA
-------------------------------	---	-------	---	---	-----	---------------

NXH80B120L2Q0

Table 3. ELECTRICAL CHARACTERISTICS $T_J = 25^\circ\text{C}$ unless otherwise noted

Parameter	Test Conditions	Symbol	Min	Typ	Max	Unit
BYPASS DIODE/IGBT PROTECTION DIODE CHARACTERISTICS						
Diode Forward Voltage	$I_F = 25\text{ A}, T_J = 25^\circ\text{C}$	V_F	–	1.0	1.4	V
	$I_F = 25\text{ A}, T_J = 150^\circ\text{C}$		–	0.90	–	
Thermal Resistance – chip-to-heatsink	Thermal grease, Thickness < 100 μm , $\lambda = 0.84\text{ W/mK}$	R_{thJH}	–	1.44	–	$^\circ\text{C/W}$

THERMISTOR CHARACTERISTICS

Nominal resistance		R_{25}	–	22	–	$\text{k}\Omega$
Nominal resistance	$T = 100^\circ\text{C}$	R_{100}	–	1486	–	Ω
Deviation of R25		$\Delta R/R$	–5	–	5	%
Power dissipation		P_D	–	200	–	mW
Power dissipation constant			–	2	–	mW/K
B-value	$B(25/50)$, tolerance $\pm 3\%$		–	3950	–	K
B-value	$B(25/100)$, tolerance $\pm 3\%$		–	3998	–	K

Product parametric performance is indicated in the Electrical Characteristics for the listed test conditions, unless otherwise noted. Product performance may not be indicated by the Electrical Characteristics if operated under different conditions.

ORDERING INFORMATION

Orderable Part Number	Marking	Package	Shipping
NXH80B120L2Q0SG	NXH80B120L2Q0SG	Q0BOOST – Case 180AJ Bare Copper DBC, Solder Pins (Pb-Free and Halide-Free)	24 Units / Blister Tray
NXH80B120L2Q0SNG	NXH80B120L2Q0SNG	Q0BOOST – Case 180AJ Nickel-Plated DBC, Solder Pins (Pb-Free and Halide-Free)	24 Units / Blister Tray

NXH80B120L2Q0

TYPICAL CHARACTERISTICS – Boost IGBT & Boost Diode

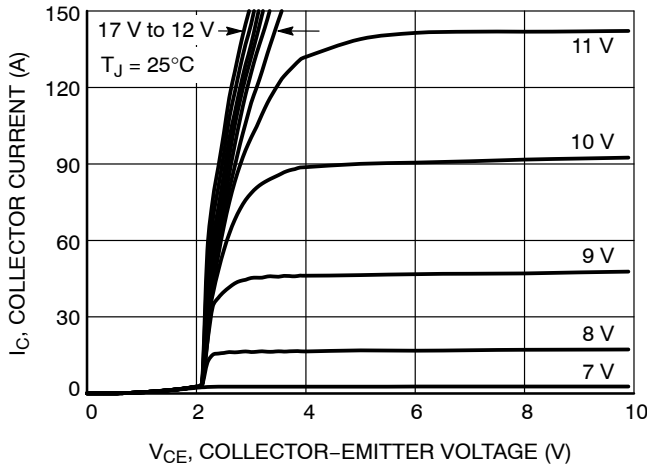

Figure 1. IGBT Typical Output Characteristics

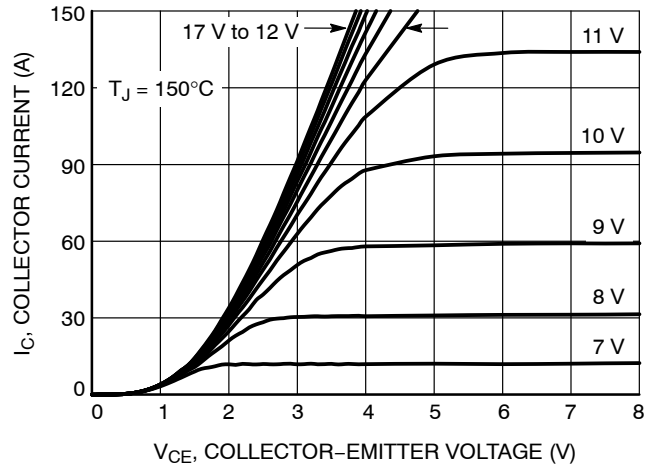

Figure 2. IGBT Typical Output Characteristics

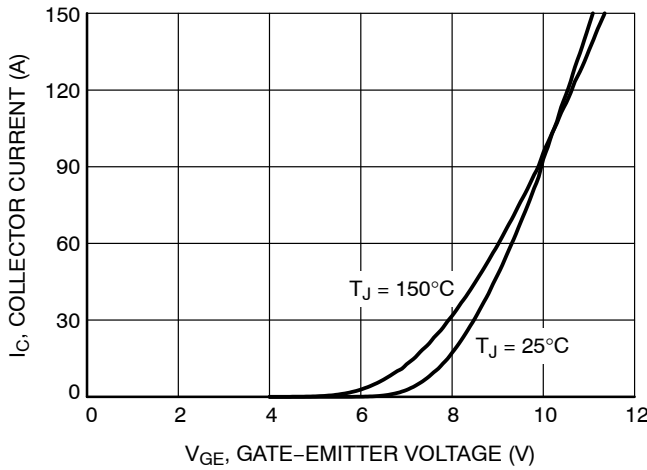

Figure 3. IGBT Typical Transfer Characteristics

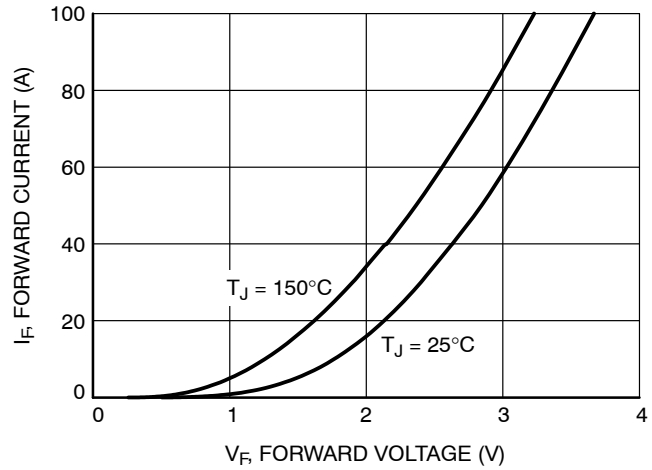

Figure 4. Diode Forward Characteristic

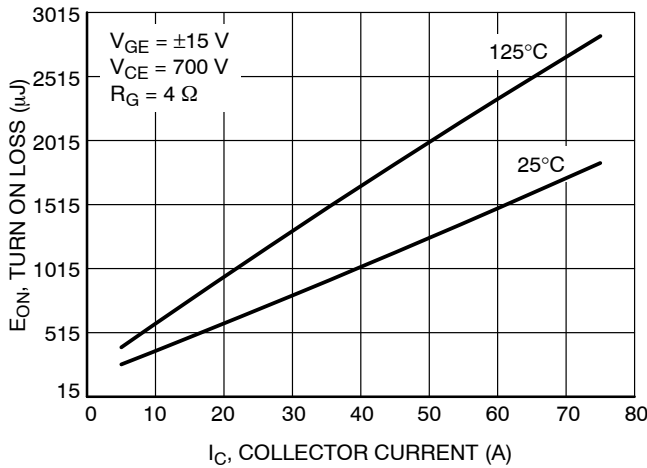

Figure 5. Typical Turn On Loss vs. Ic

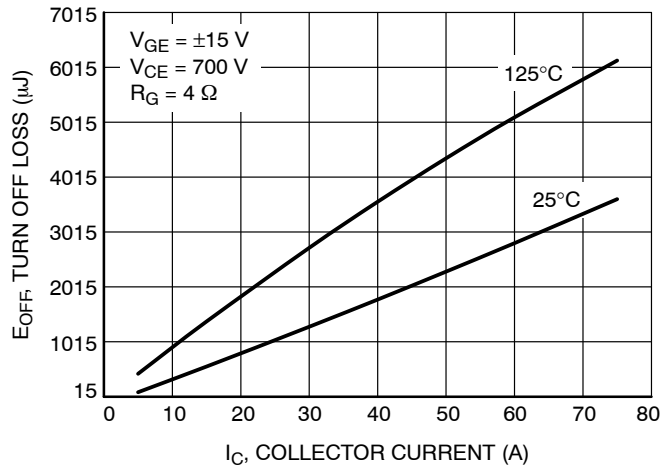

Figure 6. Typical Turn Off Loss vs. Ic

NXH80B120L2Q0

TYPICAL CHARACTERISTICS – Boost IGBT & Boost Diode

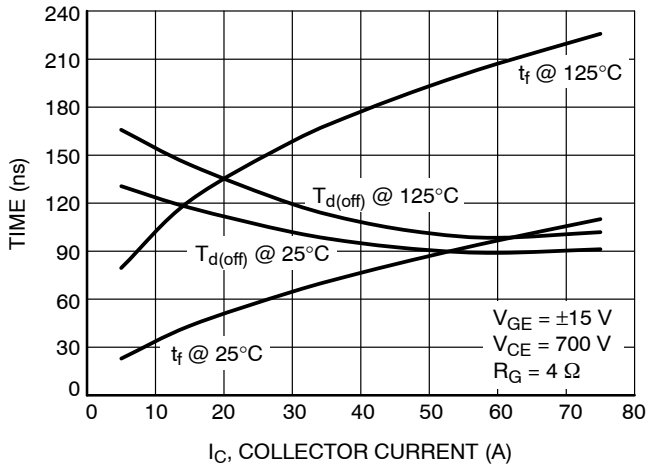

Figure 7. Typical Switching Times vs. I_C

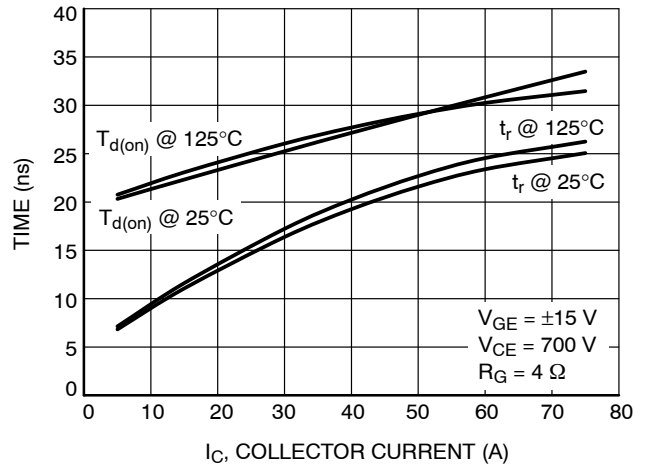

Figure 8. Typical Switching Times vs. I_C

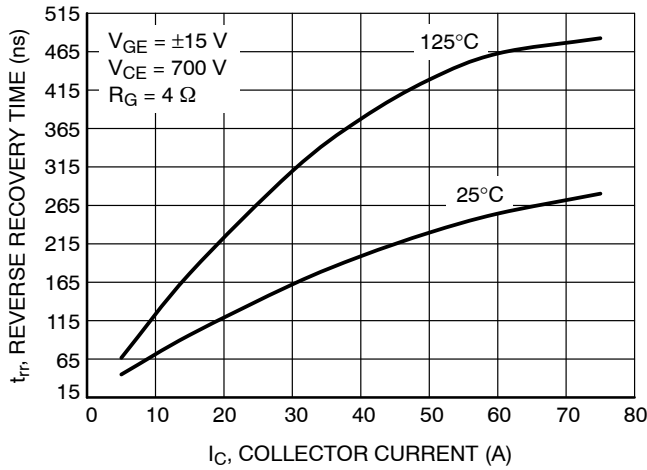

Figure 9. Typical Reverse Recovery Time vs. I_C

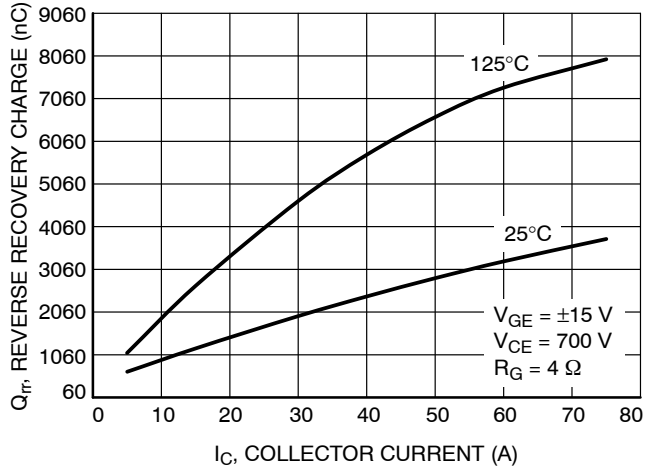

Figure 10. Typical Reverse Recovery Charge vs. I_C

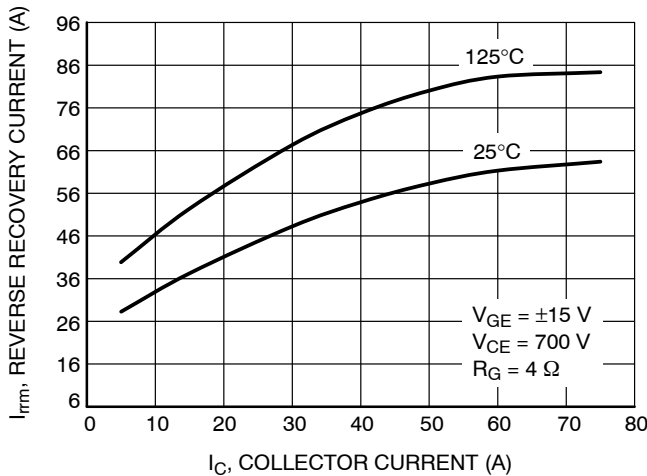

Figure 11. Typical Reverse Recovery Peak Current vs. I_C

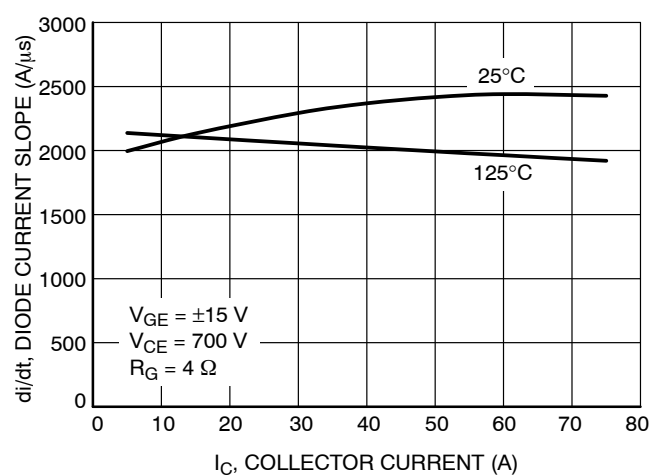

Figure 12. Typical Diode Current Slope vs. I_C

NXH80B120L2Q0

TYPICAL CHARACTERISTICS – Boost IGBT & Boost Diode

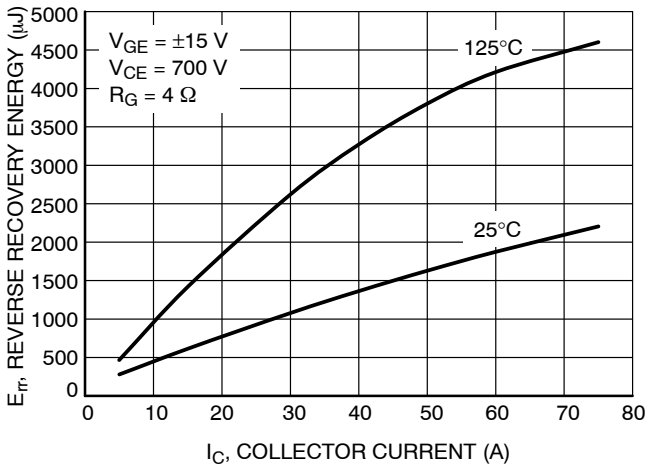

Figure 13. Typical Reverse Recovery Energy vs. I_C

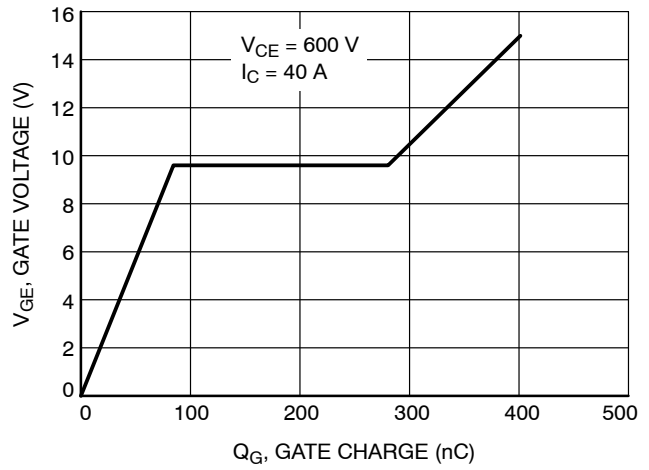

Figure 14. Gate Voltage vs. Gate Charge

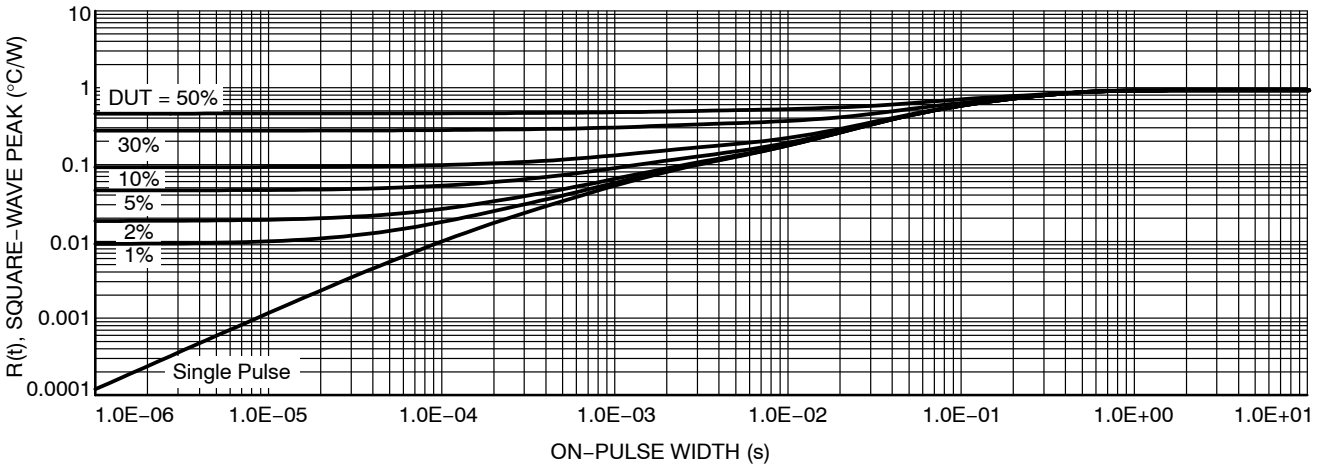

Figure 15. IGBT Transient Thermal Impedance

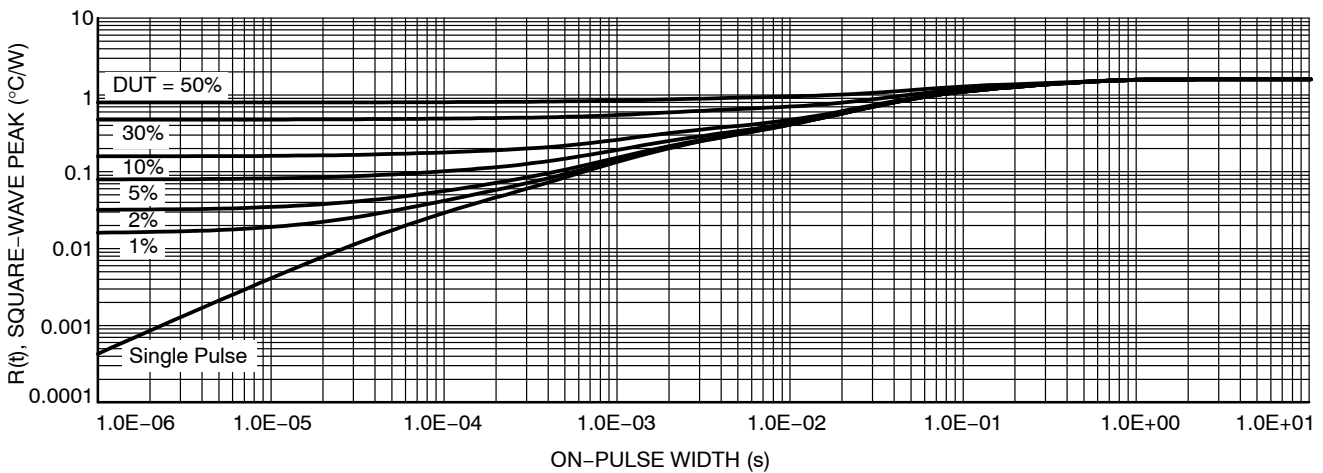

Figure 16. Diode Transient Thermal Impedance

NXH80B120L2Q0

TYPICAL CHARACTERISTICS – IGBT Protection Diode and Bypass Diode

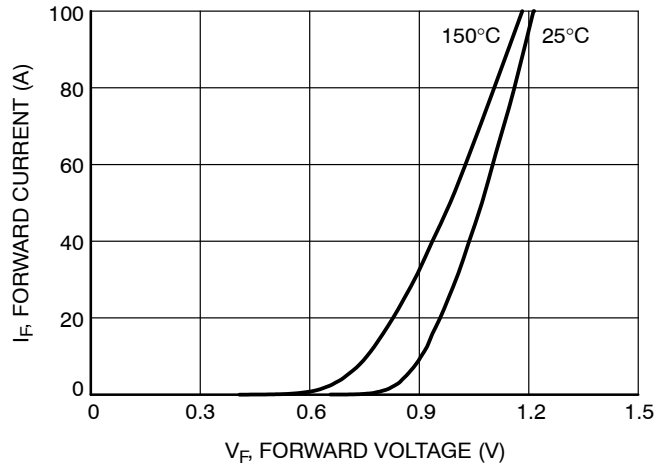

Figure 17. Diode Forward Characteristic

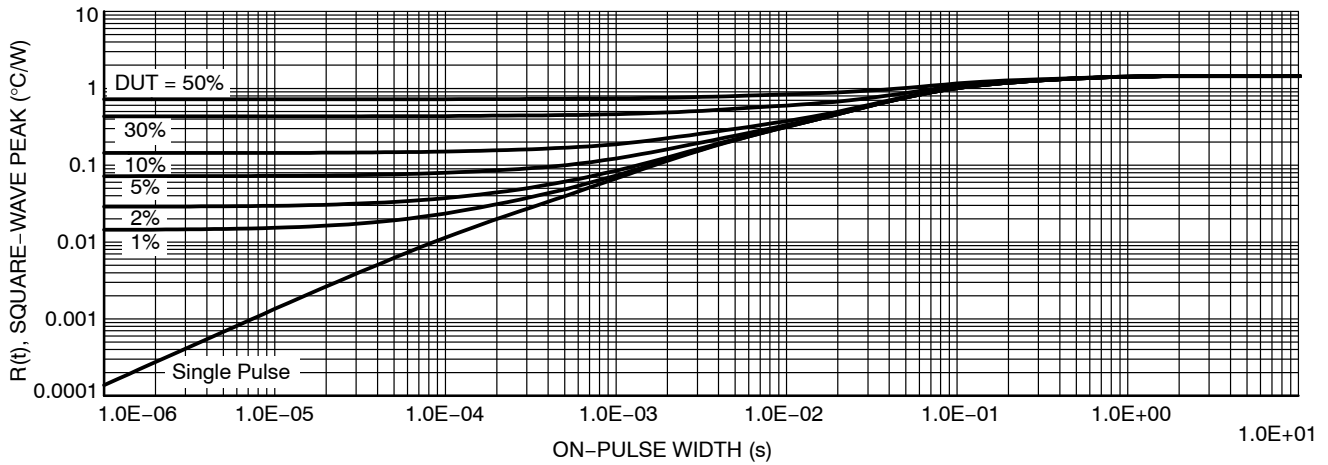

Figure 18. Diode Transient Thermal Impedance

TYPICAL CHARACTERISTICS – Thermistor

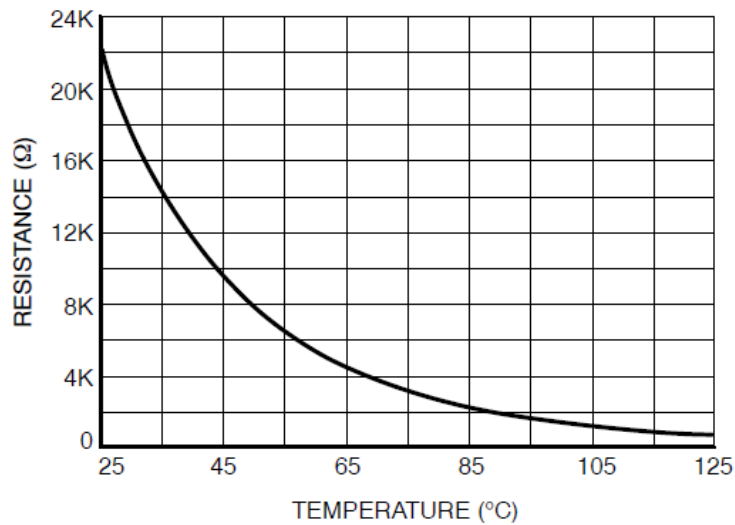

Figure 19. Thermistor Characteristic

MECHANICAL CASE OUTLINE

PACKAGE DIMENSIONS

ON Semiconductor®



PIM22, 55x32.5 / Q0BOOST CASE 180AJ ISSUE B

DATE 08 NOV 2017

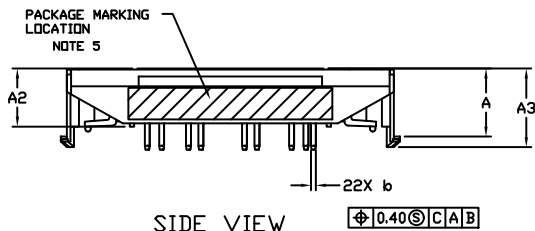
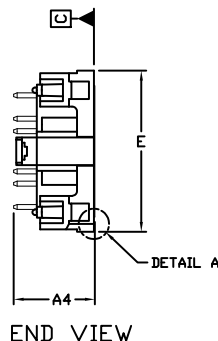
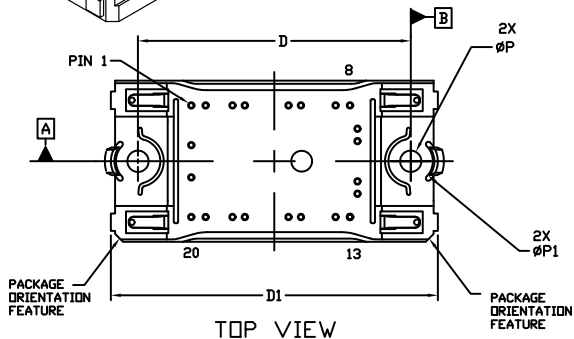
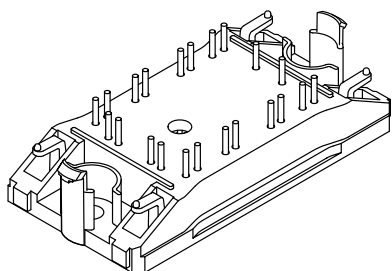

NOTES:

1. DIMENSIONING AND TOLERANCING PER ASME Y14.5M, 2009.
2. CONTROLLING DIMENSION: MILLIMETERS
3. DIMENSION b APPLIES TO THE PLATED TERMINALS AND IS MEASURED BETWEEN 1.00 AND 3.00 FROM THE TERMINAL TIP.
4. POSITION OF THE CENTER OF THE TERMINALS IS DETERMINED FROM DATUM B THE CENTER OF DIMENSION D, X DIRECTION, AND FROM DATUM A, Y DIRECTION. POSITIONAL TOLERANCE, AS NOTED IN DRAWING, APPLIES TO EACH TERMINAL IN BOTH DIRECTIONS.
5. PACKAGE MARKING IS LOCATED AS SHOWN ON THE SIDE OPPOSITE THE PACKAGE ORIENTATION FEATURES.

DIM	MILLIMETERS	
	MIN.	NDM.
A	13.50	13.90
A1	0.10	0.30
A2	11.50	11.90
A3	15.65	16.05
A4	16.35	REF
b	0.95	1.05
D	54.80	55.20
D1	65.60	66.20
E	32.20	32.80
P	4.20	4.40
P1	8.90	9.10

MOUNTING HOLE POSITION

NOTE 4

PIN	HOLE POSITION		PIN	PIN POSITION		PIN	PIN POSITION		PIN	PIN POSITION	
	X	Y		X	Y		X	Y		X	Y
1	-16.75	-11.25	12	16.75	6.55	1	-16.75	11.25	12	16.75	-6.55
2	-13.85	-11.25	13	15.25	11.25	2	-13.85	11.25	13	15.25	-11.25
3	-8.45	-11.25	14	12.35	11.25	3	-8.45	11.25	14	12.35	-11.25
4	-5.95	-11.25	15	5.35	11.25	4	-5.95	11.25	15	5.35	-11.25
5	2.85	-11.25	16	2.85	11.25	5	2.85	11.25	16	2.85	-11.25
6	5.35	-11.25	17	-5.95	11.25	6	5.35	11.25	17	-5.95	-11.25
7	12.35	-11.25	18	-8.45	11.25	7	12.35	11.25	18	-8.45	-11.25
8	15.25	-11.25	19	-13.85	11.25	8	15.25	11.25	19	-13.85	-11.25
9	16.75	-6.55	20	-16.75	11.25	9	16.75	6.55	20	-16.75	-11.25
10	16.75	-4.05	21	-16.75	3.25	10	16.75	4.05	21	-16.75	-3.25
11	16.75	4.05	22	-16.75	-3.25	11	16.75	-4.05	22	-16.75	3.25

GENERIC MARKING DIAGRAM*

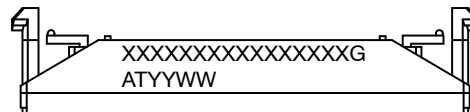

XXXXX = Specific Device Code
 G = Pb-Free Package
 AT = Assembly & Test Site Code
 YYWW = Year and Work Week Code

*This information is generic. Please refer to device data sheet for actual part marking. Pb-Free indicator, "G" or microdot "•", may or may not be present. Some products may not follow the Generic Marking.

DOCUMENT NUMBER:	98AON63481G	Electronic versions are uncontrolled except when accessed directly from the Document Repository. Printed versions are uncontrolled except when stamped "CONTROLLED COPY" in red.
DESCRIPTION:	PIM22 55X32.5 / Q0BOOST (SOLDER PIN)	PAGE 1 OF 2

ON Semiconductor and ON are trademarks of Semiconductor Components Industries, LLC dba ON Semiconductor or its subsidiaries in the United States and/or other countries. ON Semiconductor reserves the right to make changes without further notice to any products herein. ON Semiconductor makes no warranty, representation or guarantee regarding the suitability of its products for any particular purpose, nor does ON Semiconductor assume any liability arising out of the application or use of any product or circuit, and specifically disclaims any and all liability, including without limitation special, consequential or incidental damages. ON Semiconductor does not convey any license under its patent rights nor the rights of others.

PIM22, 55x32.5 / Q0BOOST
CASE 180AJ
ISSUE B

DATE 08 NOV 2017

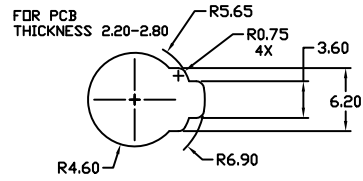
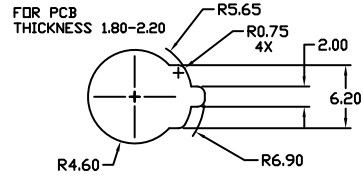
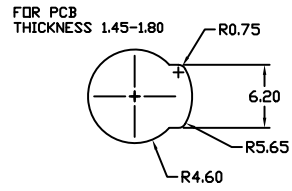
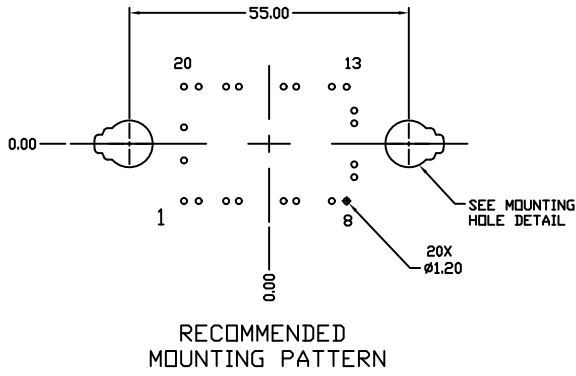

MOUNTING HOLE DETAIL

DOCUMENT NUMBER:	98AON63481G	Electronic versions are uncontrolled except when accessed directly from the Document Repository. Printed versions are uncontrolled except when stamped "CONTROLLED COPY" in red.
DESCRIPTION:	PIM22 55X32.5 / Q0BOOST (SOLDER PIN)	PAGE 2 OF 2

ON Semiconductor and are trademarks of Semiconductor Components Industries, LLC dba ON Semiconductor or its subsidiaries in the United States and/or other countries. ON Semiconductor reserves the right to make changes without further notice to any products herein. ON Semiconductor makes no warranty, representation or guarantee regarding the suitability of its products for any particular purpose, nor does ON Semiconductor assume any liability arising out of the application or use of any product or circuit, and specifically disclaims any and all liability, including without limitation special, consequential or incidental damages. ON Semiconductor does not convey any license under its patent rights nor the rights of others.

onsemi, **Onsemi**, and other names, marks, and brands are registered and/or common law trademarks of Semiconductor Components Industries, LLC dba "**onsemi**" or its affiliates and/or subsidiaries in the United States and/or other countries. **onsemi** owns the rights to a number of patents, trademarks, copyrights, trade secrets, and other intellectual property. A listing of **onsemi**'s product/patent coverage may be accessed at www.onsemi.com/site/pdf/Patent-Marking.pdf. **onsemi** reserves the right to make changes at any time to any products or information herein, without notice. The information herein is provided "as-is" and **onsemi** makes no warranty, representation or guarantee regarding the accuracy of the information, product features, availability, functionality, or suitability of its products for any particular purpose, nor does **onsemi** assume any liability arising out of the application or use of any product or circuit, and specifically disclaims any and all liability, including without limitation special, consequential or incidental damages. Buyer is responsible for its products and applications using **onsemi** products, including compliance with all laws, regulations and safety requirements or standards, regardless of any support or applications information provided by **onsemi**. "Typical" parameters which may be provided in **onsemi** data sheets and/or specifications can and do vary in different applications and actual performance may vary over time. All operating parameters, including "Typicals" must be validated for each customer application by customer's technical experts. **onsemi** does not convey any license under any of its intellectual property rights nor the rights of others. **onsemi** products are not designed, intended, or authorized for use as a critical component in life support systems or any FDA Class 3 medical devices or medical devices with a same or similar classification in a foreign jurisdiction or any devices intended for implantation in the human body. Should Buyer purchase or use **onsemi** products for any such unintended or unauthorized application, Buyer shall indemnify and hold **onsemi** and its officers, employees, subsidiaries, affiliates, and distributors harmless against all claims, costs, damages, and expenses, and reasonable attorney fees arising out of, directly or indirectly, any claim of personal injury or death associated with such unintended or unauthorized use, even if such claim alleges that **onsemi** was negligent regarding the design or manufacture of the part. **onsemi** is an Equal Opportunity/Affirmative Action Employer. This literature is subject to all applicable copyright laws and is not for resale in any manner.

ADDITIONAL INFORMATION

TECHNICAL PUBLICATIONS:

Technical Library: www.onsemi.com/design/resources/technical-documentation
onsemi Website: www.onsemi.com

ONLINE SUPPORT: www.onsemi.com/support

For additional information, please contact your local Sales Representative at www.onsemi.com/support/sales