

Silicon Carbide (SiC) Module – 11 mohm SiC M3S MOSFET, 1200 V, TNPC Topology, F2 Package

Product Preview

NXH011T120M3F2PTHG

The NXH011T120M3F2PTHG is a power module containing an 11 mΩ / 1200 V SiC MOSFET TNPC and a thermistor with HPS DBC in an F2 package.

Features

- 11 mΩ / 1200 V M3S SiC MOSFET TNPC
- HPS DBC
- Thermistor
- Options with Pre-Applied Thermal Interface Material (TIM) and without Pre-Applied TIM
- Press-Fit Pins
- These Devices are Pb-Free, Halide Free and are RoHS Compliant

Typical Applications

- Solar Inverter
- Uninterruptible Power Supplies
- Electric Vehicle Charging Stations
- Industrial Power

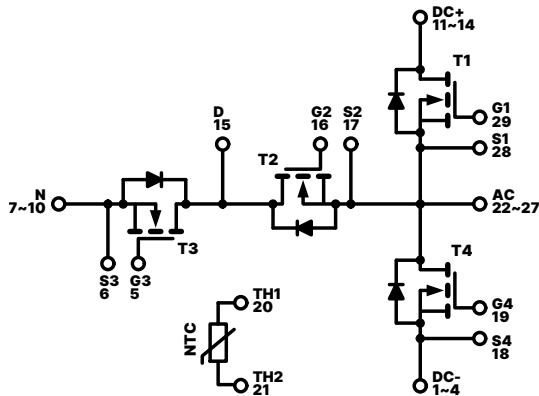
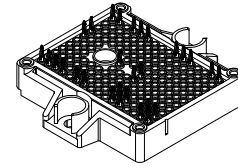

Figure 1. NXH011T120M3F2PTHG Schematic Diagram

This document contains information on a product under development. onsemi reserves the right to change or discontinue this product without notice.



PIM29 56.7x42.5 (PRESS FIT)
CASE 180HR

MARKING DIAGRAM

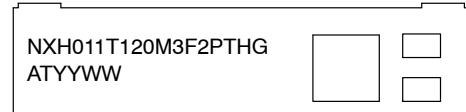

NXH011T120M3F2PTHG = Specific Device Code
AT = Assembly & Test Site Code
YYWW = Year and Work Week Code

PIN CONNECTIONS

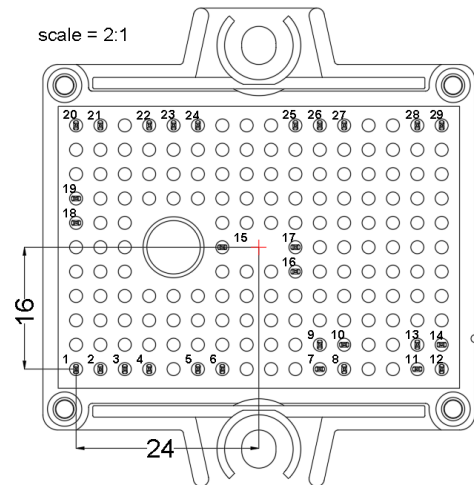

See Pin Function Description for pin names

ORDERING INFORMATION

See detailed ordering and shipping information on page 5 of this data sheet.

NXH011T120M3F2PTHG

PIN FUNCTION DESCRIPTION

Pin	Name	Description
1	DC-	DC Negative Bus connection
2	DC-	DC Negative Bus connection
3	DC-	DC Negative Bus connection
4	DC-	DC Negative Bus connection
5	G3	T3 Gate
6	S3	T3 Source
7	N	DC Neutral Point
8	N	DC Neutral Point
9	N	DC Neutral Point
10	N	DC Neutral Point
11	DC+	DC Positive Bus connection
12	DC+	DC Positive Bus connection
13	DC+	DC Positive Bus connection
14	DC+	DC Positive Bus connection
15	D	Common point drain
16	G2	T2 Gate
17	S2	T2 Source
18	S4	T4 Source
19	G4	T4 Gate
20	TH1	Thermistor Connection 1
21	TH2	Thermistor Connection 2
22	AC	AC Phase Output
23	AC	AC Phase Output
24	AC	AC Phase Output
25	AC	AC Phase Output
26	AC	AC Phase Output
27	AC	AC Phase Output
28	S1	T1 Source
29	G1	T1 Gate

NXH011T120M3F2PTHG

MAXIMUM RATINGS

Rating	Symbol	Value	Unit
SIC MOSFET			
Drain–Source Voltage	V_{DSS}	1200	V
Gate–Source Voltage	V_{GS}	+22/–10	V
Continuous Drain Current @ $T_c = 80^\circ\text{C}$ ($T_J = 175^\circ\text{C}$)	I_D	91	A
Pulsed Drain Current ($T_J = 175^\circ\text{C}$) (Note 2)	I_{Dpulse}	273	A
Maximum Power Dissipation ($T_J = 175^\circ\text{C}$)	P_{tot}	272	W
Minimum Operating Junction Temperature	T_{JMIN}	–40	$^\circ\text{C}$
Maximum Operating Junction Temperature	T_{JMAX}	175	$^\circ\text{C}$

THERMAL PROPERTIES

Storage Temperature Range	T_{stg}	–40 to 150	$^\circ\text{C}$
TIM Layer Thickness	T_{TIM}	160 ± 20	μm

INSULATION PROPERTIES

Isolation test voltage, $t = 1$ sec, 60 Hz	V_{is}	4800	V_{RMS}
Creepage distance		12.7	mm
CTI		600	
Substrate Ceramic Material		HPS	
Substrate Ceramic Material Thickness		0.38	mm
Substrate Warpage (Note 2)	W	Max 0.18	mm

Stresses exceeding those listed in the Maximum Ratings table may damage the device. If any of these limits are exceeded, device functionality should not be assumed, damage may occur and reliability may be affected.

1. Refer to ELECTRICAL CHARACTERISTICS, RECOMMENDED OPERATING RANGES and/or APPLICATION INFORMATION for Safe Operating parameters.
2. Height difference between horizontal plane and substrate copper bottom.

RECOMMENDED OPERATING RANGES

Rating	Symbol	Min	Max	Unit
Module Operating Junction Temperature	T_J	–40	150	$^\circ\text{C}$

Functional operation above the stresses listed in the Recommended Operating Ranges is not implied. Extended exposure to stresses beyond the Recommended Operating Ranges limits may affect device reliability.

ELECTRICAL CHARACTERISTICS

$T_J = 25^\circ\text{C}$ unless otherwise noted

Parameter	Test Conditions	Symbol	Min	Typ	Max	Unit
SIC MOSFET CHARACTERISTICS						
Zero Gate Voltage Drain Current	$V_{GS} = 0\text{ V}, V_{DS} = 1200\text{ V}$	I_{DSS}	–	–	300	μA
Drain–Source On Resistance	$V_{GS} = 18\text{ V}, I_D = 70\text{ A}, T_J = 25^\circ\text{C}$	$R_{DS(ON)}$	–	11.9	16	m Ω
	$V_{GS} = 18\text{ V}, I_D = 70\text{ A}, T_J = 125^\circ\text{C}$		–	21.5	–	
	$V_{GS} = 18\text{ V}, I_D = 70\text{ A}, T_J = 150^\circ\text{C}$		–	24.1	–	
	$V_{GS} = 18\text{ V}, I_D = 70\text{ A}, T_J = 175^\circ\text{C}$		–	28.1	–	
Gate–Source Threshold Voltage	$V_{GS} = V_{DS}, I_D = 40\text{ mA}$	$V_{GS(TH)}$	1.8	2.8	4.4	V
Gate Leakage Current	$V_{GS} = -10\text{ V} / 20\text{ V}, V_{DS} = 0\text{ V}$	I_{GSS}	–600	–	600	nA
Input Capacitance	$V_{DS} = 800\text{ V}, V_{GS} = 0\text{ V}, f = 100\text{ kHz}$	C_{ISS}	–	6331	–	pF
Reverse Transfer Capacitance		C_{RSS}	–	29	–	
Output Capacitance		C_{OSS}	–	354	–	

NXH011T120M3F2PTHG

ELECTRICAL CHARACTERISTICS (continued)

T_J = 25 °C unless otherwise noted

Parameter	Test Conditions	Symbol	Min	Typ	Max	Unit
-----------	-----------------	--------	-----	-----	-----	------

SiC MOSFET CHARACTERISTICS

Total Gate Charge	V _{DS} = 800 V, V _{GS} = -5/20 V, I _D = 200 A	Q _{G(TOTAL)}	-	306	-	nC
Gate-Source Charge		Q _{GS}	-	31	-	nC
Gate-Drain Charge		Q _{GD}	-	78	-	nC

SiC MOSFET CHARACTERISTICS - Halfbridge Commutation Path

Turn-on Delay Time	T _J = 25°C V _{DS} = 400 V, I _D = 70 A V _{GS} = -3 V / 18 V, R _G = 2.7 Ω	t _{d(on)}	-	40.1	-	ns
Rise Time		t _r	-	14.5	-	
Turn-off Delay Time		t _{d(off)}	-	111.3	-	
Fall Time		t _f	-	10.4	-	
Turn-on Switching Loss per Pulse		E _{ON}	-	0.33	-	mJ
Turn-off Switching Loss per Pulse		E _{OFF}	-	0.13	-	
Turn-on Delay Time	T _J = 150°C V _{DS} = 400 V, I _D = 70 A V _{GS} = -3 V / 18 V, R _G = 2.7 Ω	t _{d(on)}	-	38	-	ns
Rise Time		t _r	-	12.81	-	
Turn-off Delay Time		t _{d(off)}	-	124	-	
Fall Time		t _f	-	12.2	-	
Turn-on Switching Loss per Pulse		E _{ON}	-	0.38	-	mJ
Turn off Switching Loss per Pulse		E _{OFF}	-	0.17	-	
Diode Forward Voltage	I _D = 70 A, T _J = 25°C, V _{GS} = -3 V	V _{SD}	-	5.18	6.5	V
	I _D = 70 A, T _J = 125°C, V _{GS} = -3 V		-	4.78	-	
	I _D = 70 A, T _J = 150°C		-	4.72	-	
Thermal Resistance - Chip-to-Case	T1, T2, T3, T4	R _{thJC}	-	0.349	-	°C/W
Thermal Resistance - Chip-to-Heatsink	Thermal grease, Thickness = 2 Mil +2%, A = 2.8 W/mK	R _{thJH}	-	0.548	-	°C/W

SiC MOSFET CHARACTERISTICS - Neutral Point Commutation Path

Turn-on Delay Time	T _J = 25°C V _{DS} = 400 V, I _D = 70 A V _{GS} = -5 V / 18 V, R _G = 2.7 Ω	t _{d(on)}	-	40.8	-	ns
Rise Time		t _r	-	13.8	-	
Turn-off Delay Time		t _{d(off)}	-	112.6	-	
Fall Time		t _f	-	8.7	-	
Turn-on Switching Loss per Pulse		E _{ON}	-	0.34	-	mJ
Turn-off Switching Loss per Pulse		E _{OFF}	-	0.18	-	
Turn-on Delay Time	T _J = 150°C V _{DS} = 400 V, I _D = 70 A V _{GS} = -3 V / 18 V, R _G = 2.7 Ω	t _{d(on)}	-	38.4	-	ns
Rise Time		t _r	-	12.0	-	
Turn-off Delay Time		t _{d(off)}	-	137	-	
Fall Time		t _f	-	8.9	-	
Turn-on Switching Loss per Pulse		E _{ON}	-	0.38	-	mJ
Turn off Switching Loss per Pulse		E _{OFF}	-	0.23	-	

THERMISTOR CHARACTERISTICS

Nominal Resistance	TNTC = 25°C	R ₂₅	-	5	-	kΩ
	TNTC = 100°C	R ₁₀₀	-	493	-	Ω
	TNTC = 150°C	R ₁₅₀	-	159.5	-	Ω
Deviation of R100	TNTC = 100°C	ΔR/R	-5	-	5	%

NXH011T120M3F2PTHG

ELECTRICAL CHARACTERISTICS (continued)

T_J = 25 °C unless otherwise noted

Parameter	Test Conditions	Symbol	Min	Typ	Max	Unit
THERMISTOR CHARACTERISTICS						
Power Dissipation – Recommended Limit	0.15 mA. Non-Self-heating Effect	P _D	–	0.1	–	mW
Power Dissipation – Absolute Maximum	5 mA	P _D	–	34.2	–	mW
Power Dissipation Constant			–	1.4	–	mW/K
B-value	B(25/50), tolerance ±2%		–	3375	–	K
B-value	B(25/100), tolerance ±2%		–	3436	–	K

Product parametric performance is indicated in the Electrical Characteristics for the listed test conditions, unless otherwise noted. Product performance may not be indicated by the Electrical Characteristics if operated under different conditions.

ORDERING INFORMATION

Orderable Part Number	Marking	Package	Shipping
NXH011T120M3F2PTHG	NXH011T120M3F2PTHG	F2-TNPC: Case 180HR Press-fit Pins with pre-applied thermal interface material (TIM) (Pb-Free / Halide Free)	20 Units / Blister Tray

NXH011T120M3F2PTHG

TYPICAL CHARACTERISTICS M1/M2 SIC MOSFET CHARACTERISTIC

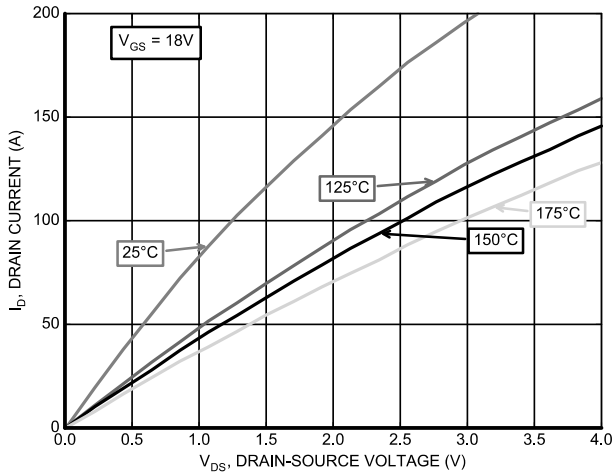

Figure 2. MOSFET Typical Output Characteristic

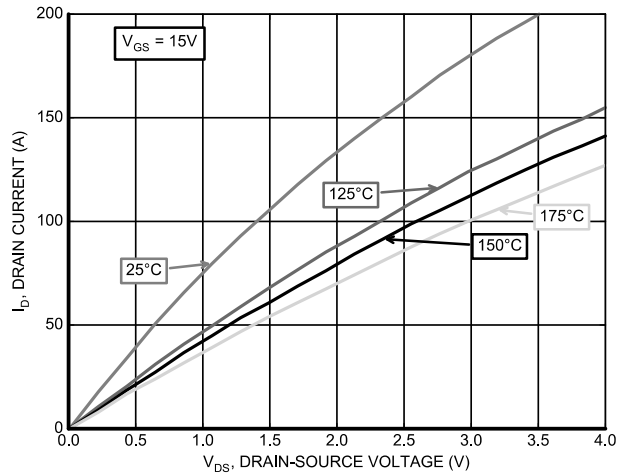

Figure 3. MOSFET Typical Output Characteristic

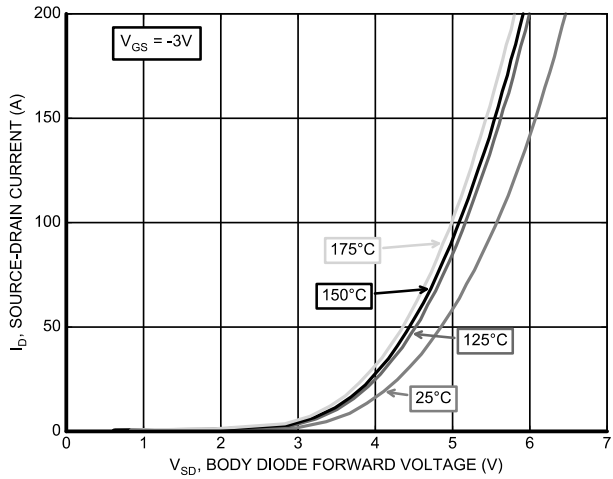

Figure 4. I_D vs. V_{SD}

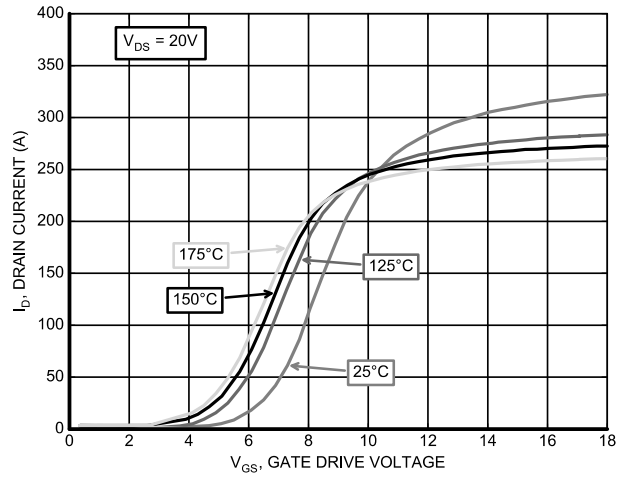

Figure 5. I_D vs. V_{GS}

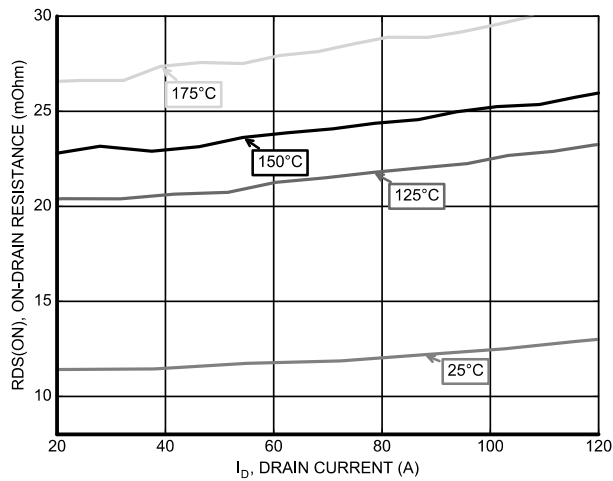

Figure 6. $R_{DS(ON)}$ vs. I_D

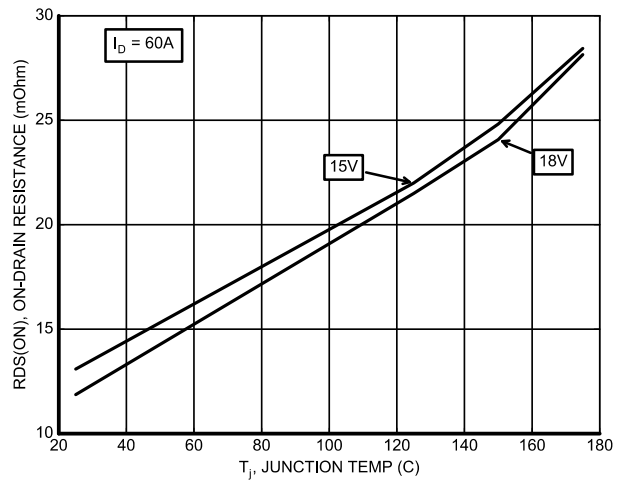

Figure 7. $R_{DS(ON)}$ vs. T_J

NXH011T120M3F2PTHG

TYPICAL CHARACTERISTICS M1/M2 SIC MOSFET CHARACTERISTIC

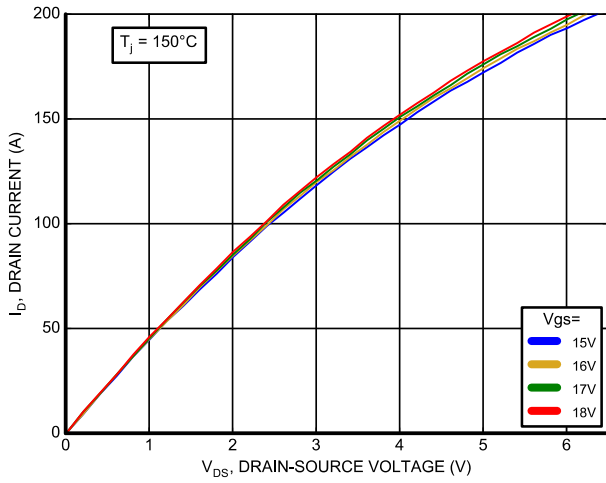

Figure 8. I_D vs. V_{DS}

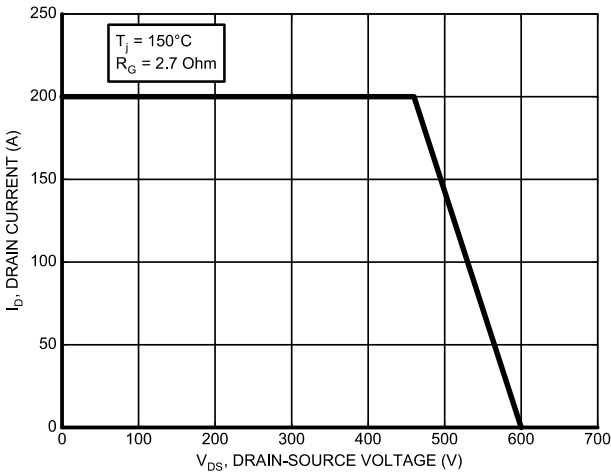

Figure 9. I_D vs. V_{SD}

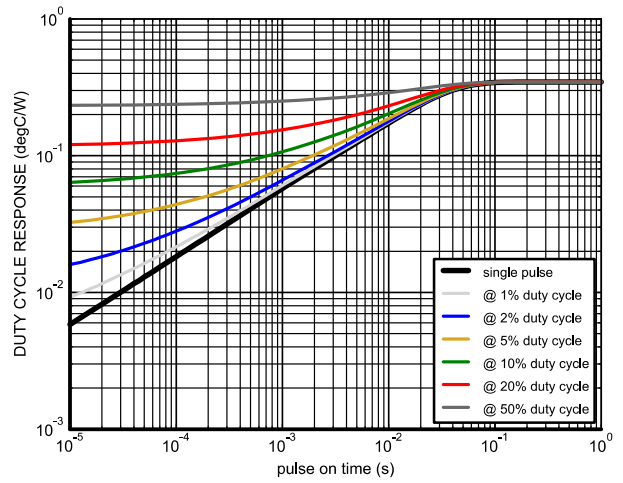

Figure 10. Duty Cycle Response vs. Pulse On Time

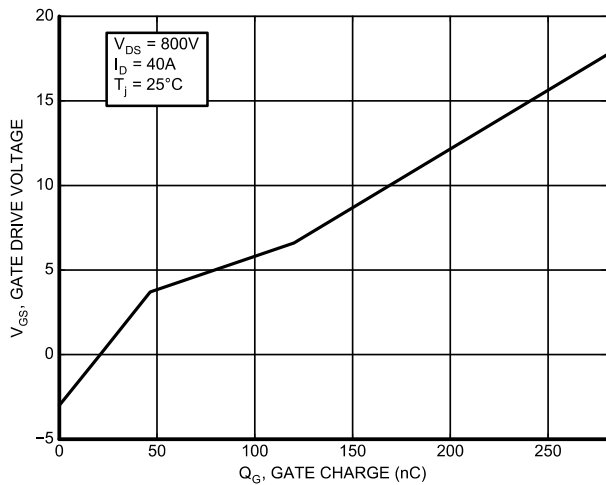

Figure 11. V_{GS} vs. Q_G

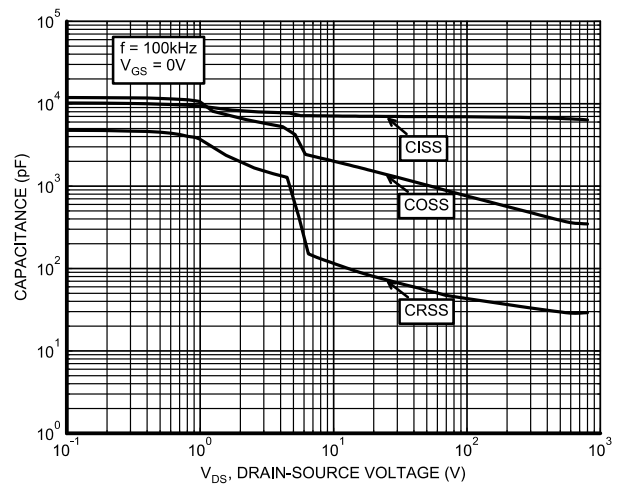

Figure 12. Capacitance vs. V_{DS}

NXH011T120M3F2PTHG

TYPICAL CHARACTERISTICS – HB COMMUTATION PATH

M1/M2 SIC MOSFET SWITCHING CHARACTERISTIC

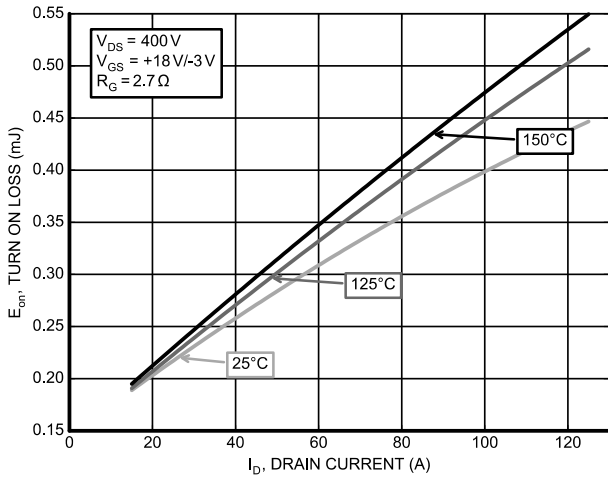

Figure 13. E_{on} vs. I_D

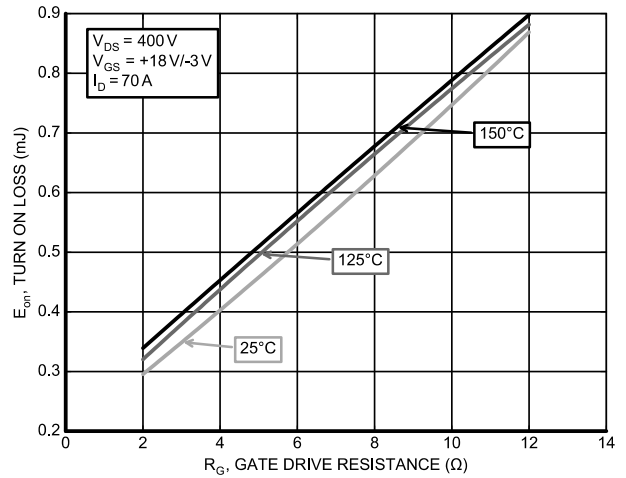

Figure 14. E_{on} vs. R_G

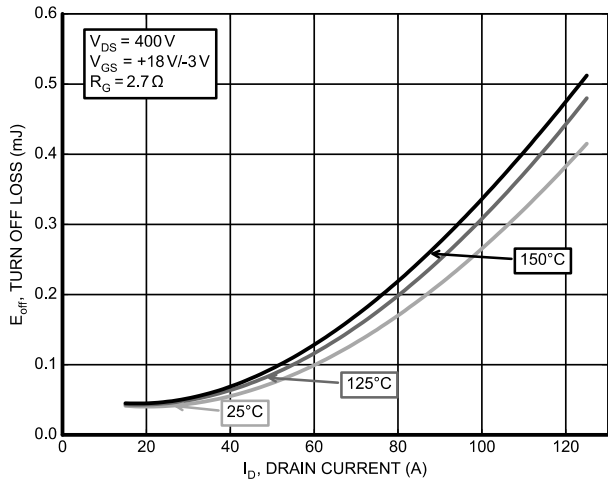

Figure 15. E_{off} vs. I_D

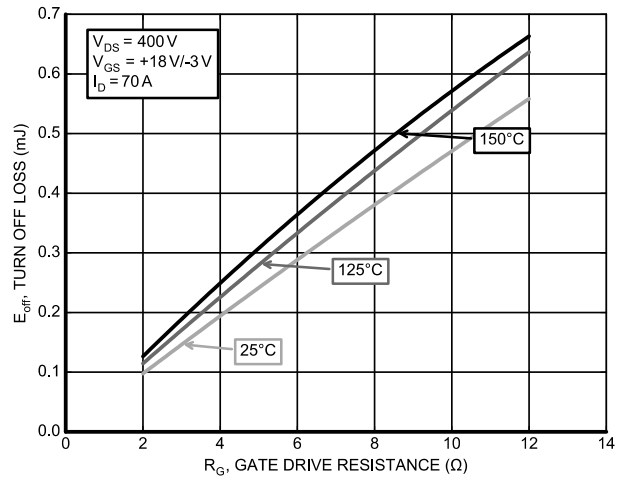

Figure 16. E_{off} vs. R_G

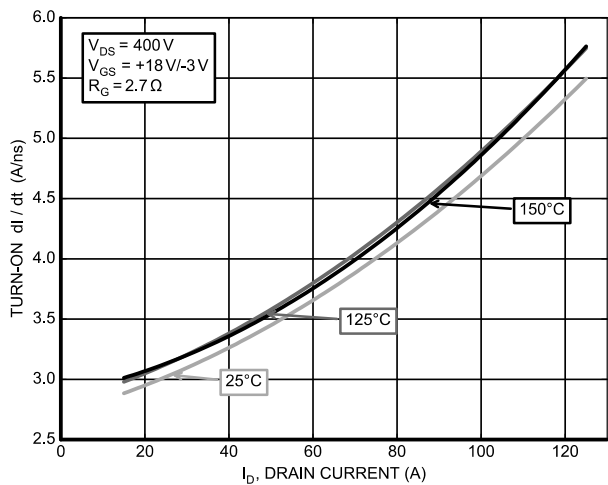

Figure 17. Turn-on di/dt vs. I_D

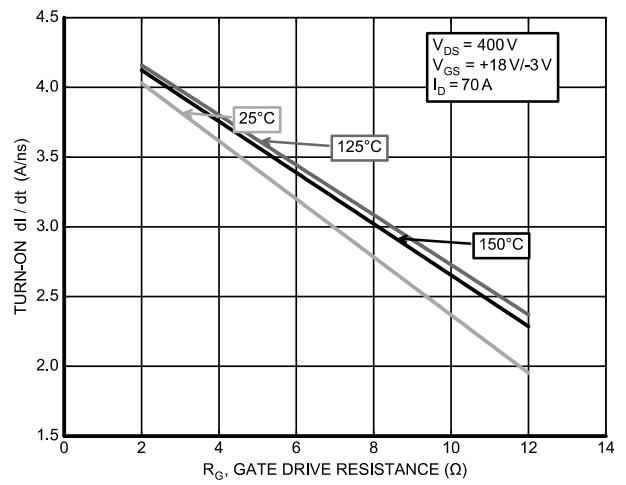

Figure 18. Turn-on di/dt vs. R_G

NXH011T120M3F2PTHG

TYPICAL CHARACTERISTICS – HB COMMUTATION PATH

M1/M2 SIC MOSFET SWITCHING CHARACTERISTIC

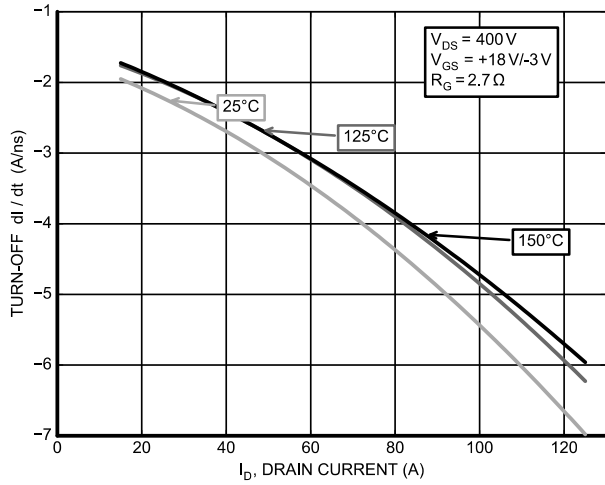

Figure 19. Turn-off di/dt vs. I_D

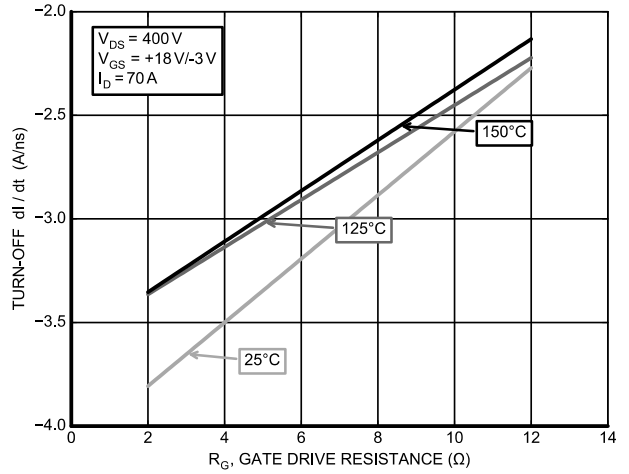

Figure 20. Turn-off di/dt vs. R_G

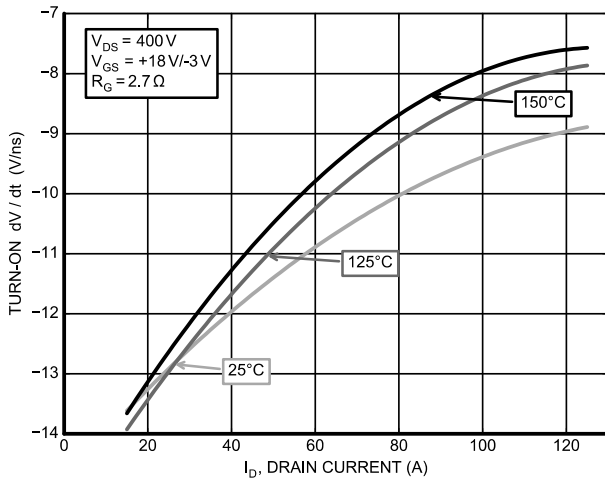

Figure 21. Turn-on dv/dt vs. I_D

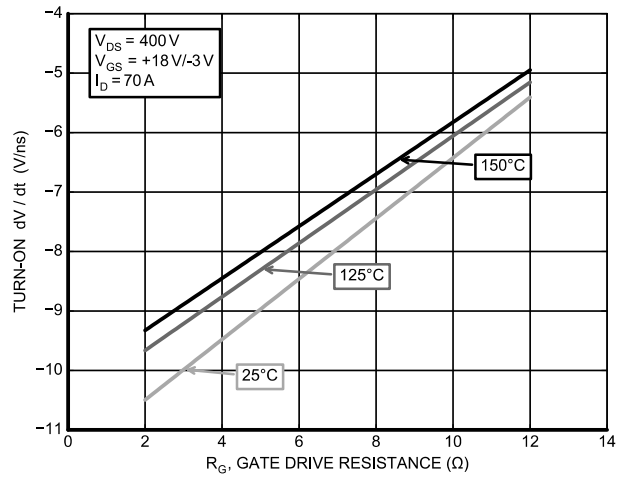

Figure 22. Turn-on dv/dt vs. R_G

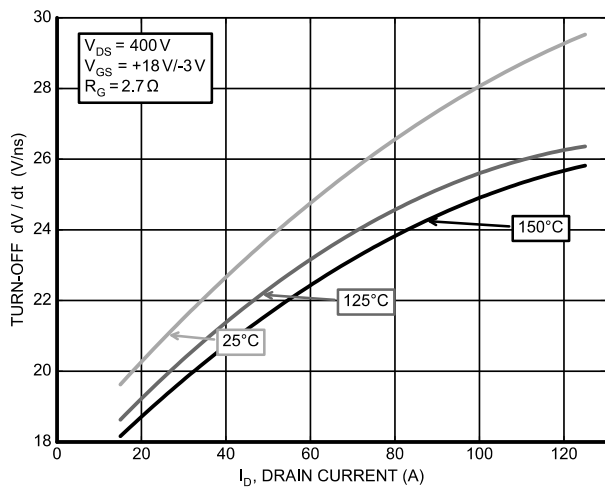

Figure 23. Turn-off dv/dt vs. I_D

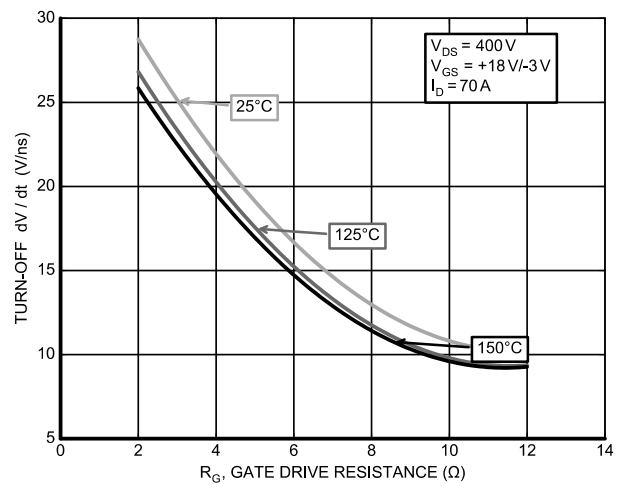

Figure 24. Turn-off dv/dt vs. R_G

NXH011T120M3F2PTHG

TYPICAL CHARACTERISTICS – HB COMMUTATION PATH

M1/M2 SIC MOSFET SWITCHING CHARACTERISTIC

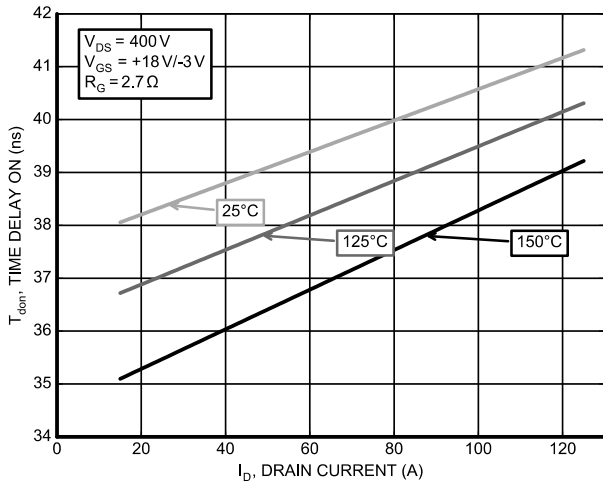

Figure 25. T_{don} vs. I_D

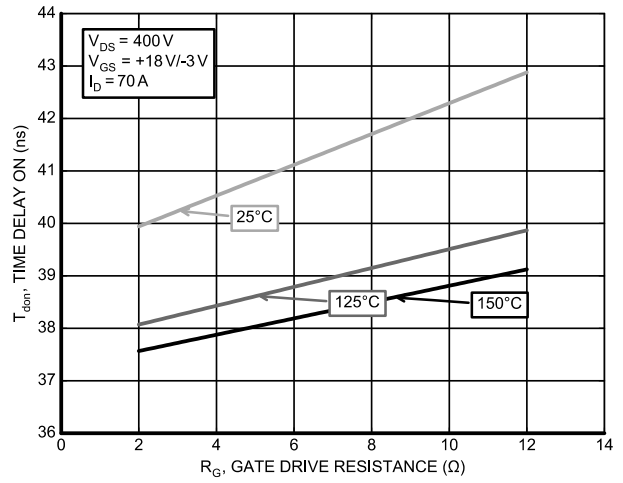

Figure 26. T_{don} vs. R_G

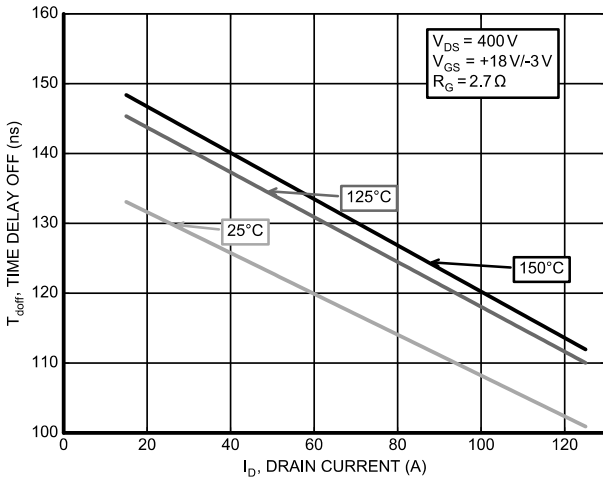

Figure 27. T_{doff} vs. I_D

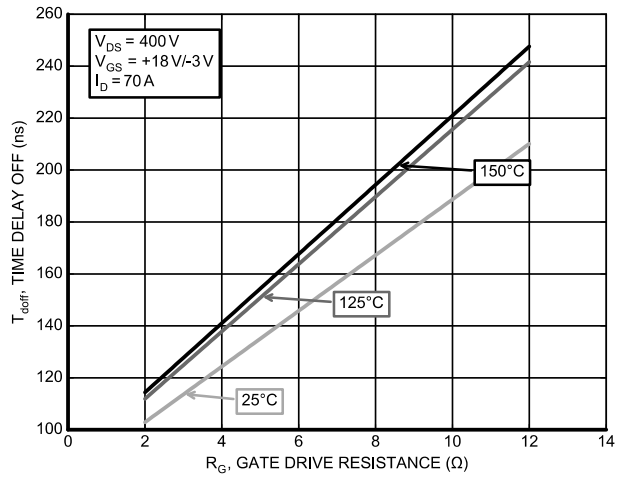

Figure 28. T_{doff} vs. R_G

NXH011T120M3F2PTHG

TYPICAL CHARACTERISTICS – NP COMMUTATION PATH

M1/M2 SIC MOSFET SWITCHING CHARACTERISTIC

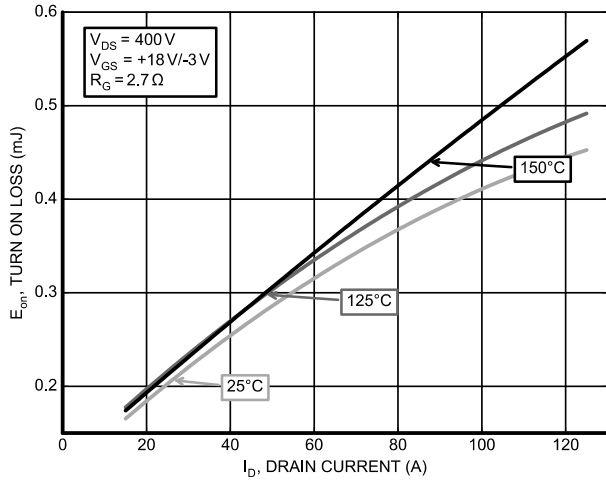

Figure 29. E_{on} vs. I_D

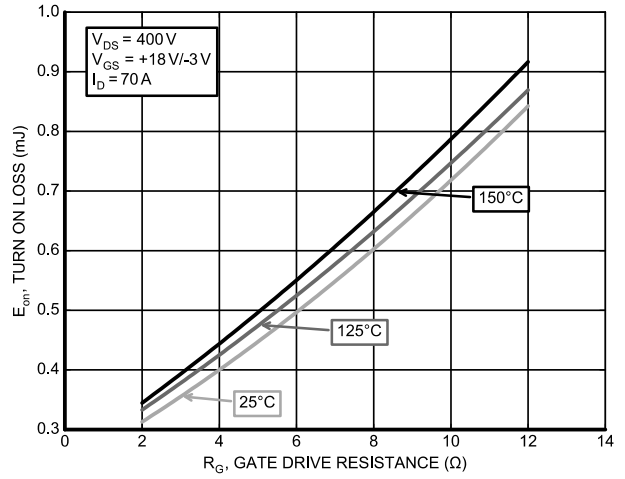

Figure 30. E_{on} vs. R_G

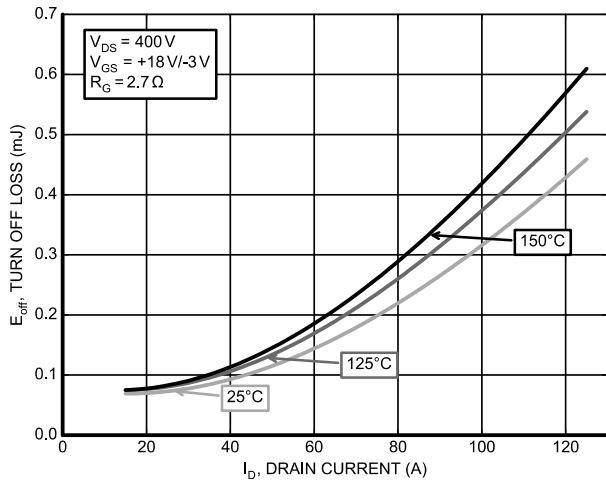

Figure 31. E_{off} vs. I_D

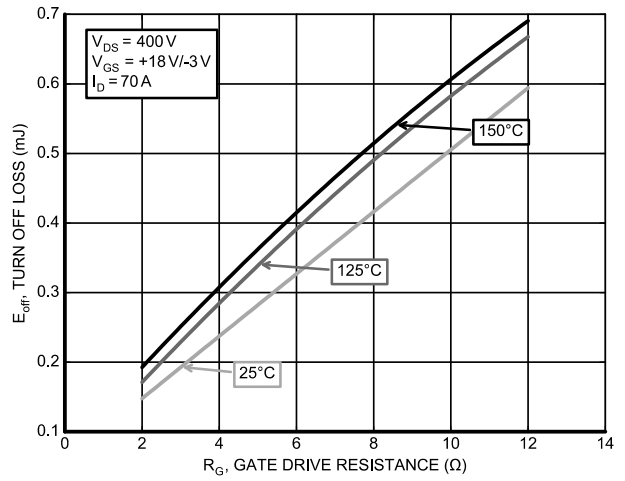

Figure 32. E_{off} vs. R_G

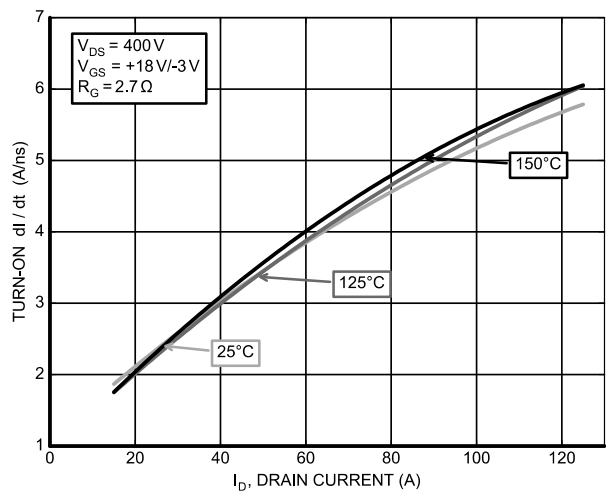

Figure 33. Turn-on di/dt vs. I_D

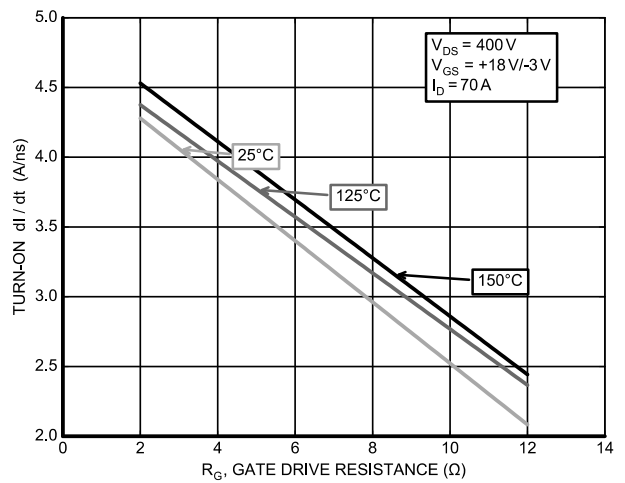

Figure 34. Turn-on di/dt vs. R_G

NXH011T120M3F2PTHG

TYPICAL CHARACTERISTICS – NP COMMUTATION PATH

M1/M2 SIC MOSFET SWITCHING CHARACTERISTIC

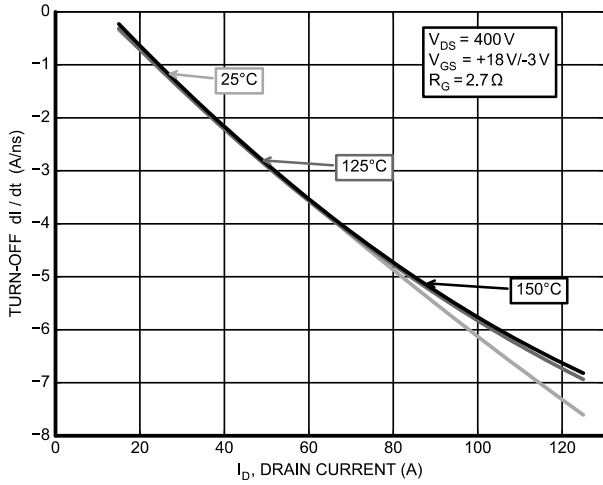

Figure 35. Turn-off di/dt vs. I_D

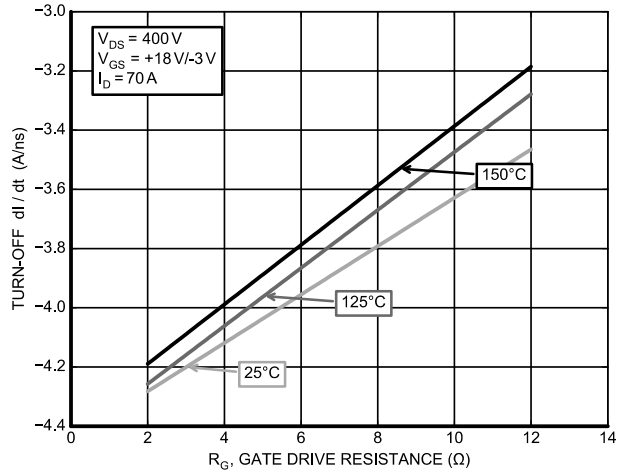

Figure 36. Turn-off di/dt vs. R_G

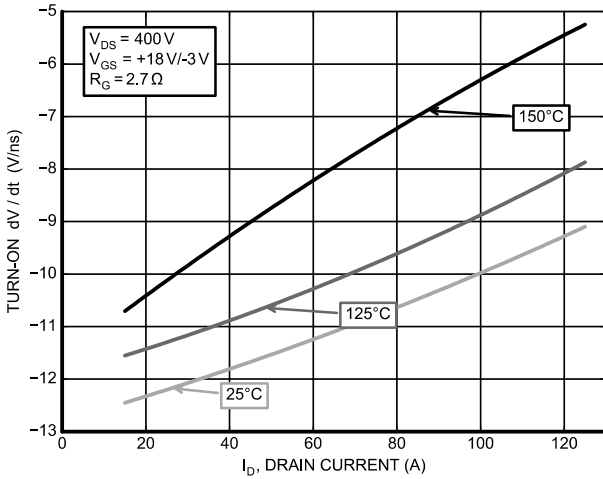

Figure 37. Turn-on dv/dt vs. I_D

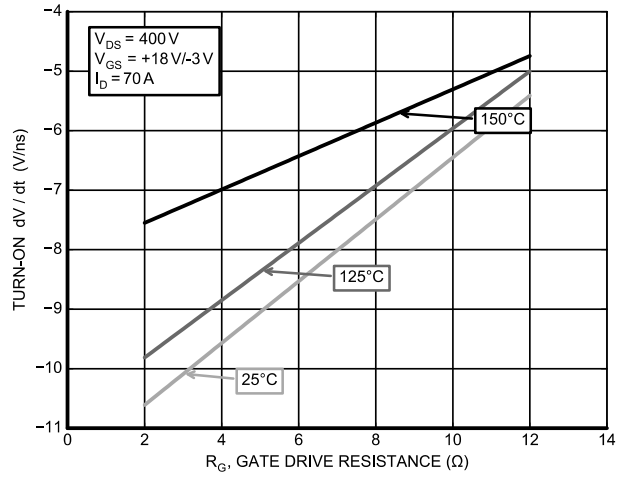

Figure 38. Turn-on dv/dt vs. R_G

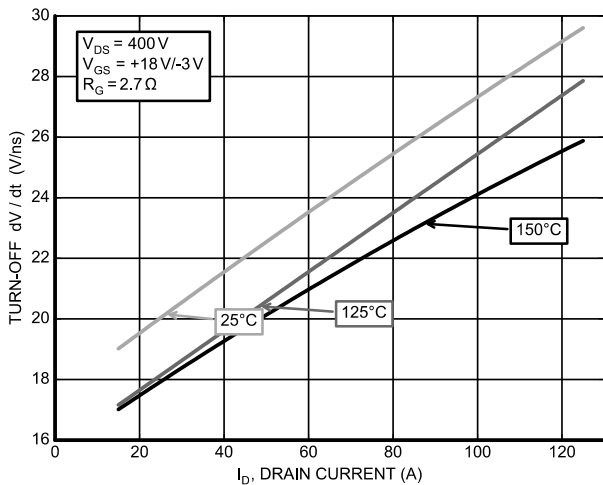

Figure 39. Turn-off dv/dt vs. I_D

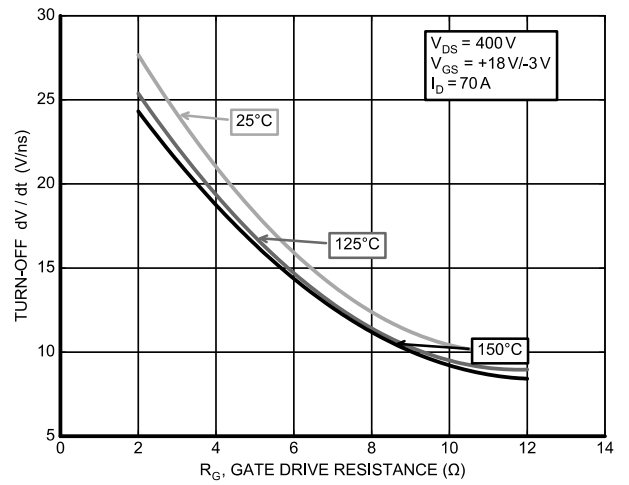

Figure 40. Turn-off dv/dt vs. R_G

NXH011T120M3F2PTHG

TYPICAL CHARACTERISTICS – NP COMMUTATION PATH

M1/M2 SIC MOSFET SWITCHING CHARACTERISTIC

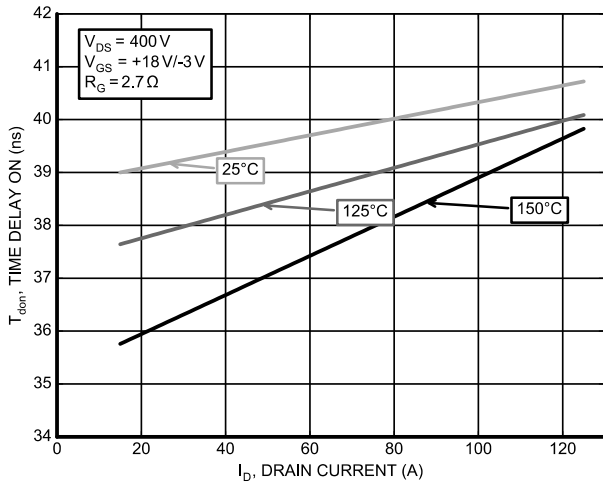

Figure 41. T_{don} vs. I_D

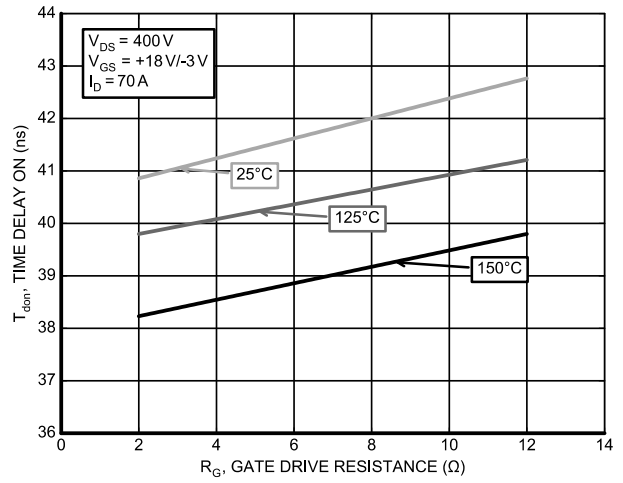

Figure 42. T_{don} vs. R_G

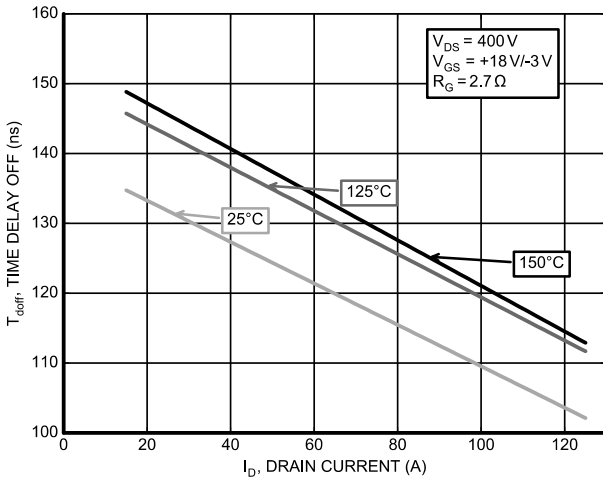

Figure 43. T_{doff} vs. I_D

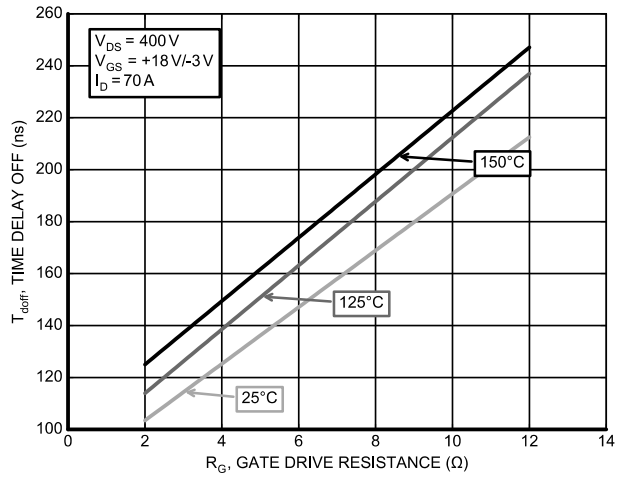

Figure 44. T_{doff} vs. R_G

NXH011T120M3F2PTHG

CAUER NETWORKS – M1, M2

Cauer Element #	M1,2	
	Rth (K/W)	Cth (Ws/K)
1	0.029384	0.005433
2	0.06356	0.016248
3	0.088601	0.038021
4	0.091938	0.034252
5	0.073668	0.078985

FOSTER NETWORKS – M1, M2

Cauer Element #	M1,2	
	Rth (K/W)	Cth (Ws/K)
1	0.014874	0.007783
2	0.018344	0.041519
3	0.016552786	0.081928011
4	0.027204	0.141411
5	0.270176	0.081891

NXH011T120M3F2PTHG

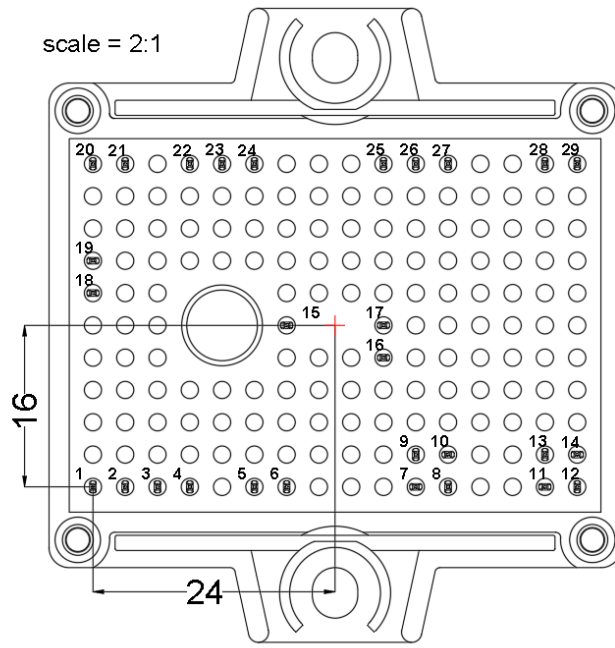

Figure 45. Pin Connections

PIN FUNCTIONS

Pin #	X	Y	Function	Pin #	X	Y	Function
1	0	0	DC-	16	28.8	12.8	G2
2	3.2	0	DC-	17	28.8	16	S2
3	6.4	0	DC-	18	0	19.2	S4
4	9.6	0	DC-	19	0	22.4	G4
5	16	0	G3	20	0	32	TH1
6	19.2	0	S3	21	3.2	32	TH2
7	32	0	N	22	9.6	32	AC
8	35.2	0	N	23	12.8	32	AC
9	32	3.2	N	24	16	32	AC
10	35.2	3.2	N	25	28.8	32	AC
11	44.8	0	DC+	26	32	32	AC
12	48	0	DC+	27	35.2	32	AC
13	44.8	3.2	DC+	28	44.8	32	S1
14	48	3.2	DC+	29	48	32	G1
15	19.2	16	D				

NXH011T120M3F2PTHG

PACKAGE DIMENSIONS

PIM29, 56.7x42.5 (PRESS FIT)
CASE 180HR
ISSUE O

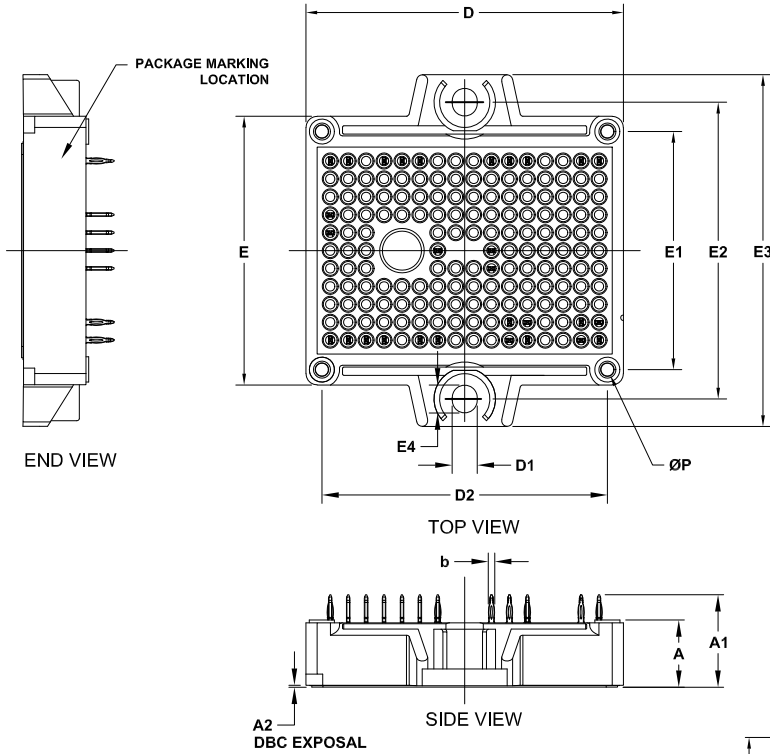

NOTES:

1. CONTROLLING DIMENSION: MILLIMETERS
2. PIN POSITION TOLERANCE IS $\pm 0.4\text{mm}$

DIM	MILLIMETERS		
	MIN.	NOM.	MAX.
A	11.65	12.00	12.35
A1	16.00	16.50	17.00
A2	0.00	0.35	0.60
A3	12.85	13.35	13.85
b	1.15	1.20	1.25
b1	0.59	0.64	0.69
D	56.40	56.70	57.00
D1	4.40	4.50	4.60
D2	50.85	51.00	51.15
E	47.70	48.00	48.30
E1	42.35	42.50	42.65
E2	52.90	53.00	53.10
E3	62.30	62.80	63.30
E4	4.90	5.00	5.10
P	2.20	2.30	2.40

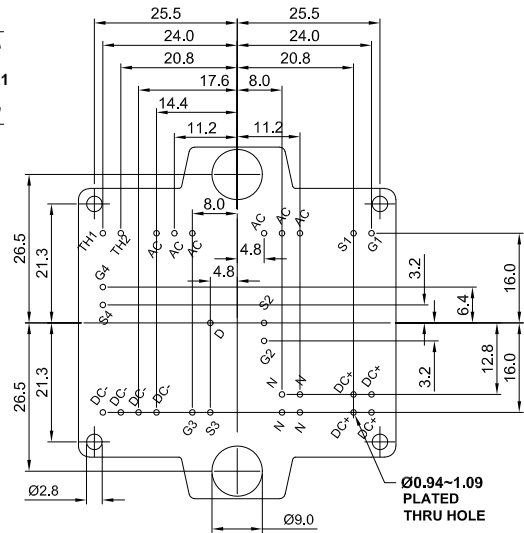

RECOMMENDED MOUNTING PATTERN

* For additional information on our Pb-Free strategy and soldering details, please download the ON Semiconductor Soldering and Mounting Techniques Reference Manual, SOLDER RM/D.

onsemi, **Onsemi**, and other names, marks, and brands are registered and/or common law trademarks of Semiconductor Components Industries, LLC dba "**onsemi**" or its affiliates and/or subsidiaries in the United States and/or other countries. **onsemi** owns the rights to a number of patents, trademarks, copyrights, trade secrets, and other intellectual property. A listing of **onsemi**'s product/patent coverage may be accessed at www.onsemi.com/site/pdf/Patent-Marking.pdf. **onsemi** reserves the right to make changes at any time to any products or information herein, without notice. The information herein is provided "as-is" and **onsemi** makes no warranty, representation or guarantee regarding the accuracy of the information, product features, availability, functionality, or suitability of its products for any particular purpose, nor does **onsemi** assume any liability arising out of the application or use of any product or circuit, and specifically disclaims any and all liability, including without limitation special, consequential or incidental damages. Buyer is responsible for its products and applications using **onsemi** products, including compliance with all laws, regulations and safety requirements or standards, regardless of any support or applications information provided by **onsemi**. "Typical" parameters which may be provided in **onsemi** data sheets and/or specifications can and do vary in different applications and actual performance may vary over time. All operating parameters, including "Typicals" must be validated for each customer application by customer's technical experts. **onsemi** does not convey any license under any of its intellectual property rights nor the rights of others. **onsemi** products are not designed, intended, or authorized for use as a critical component in life support systems or any FDA Class 3 medical devices or medical devices with a same or similar classification in a foreign jurisdiction or any devices intended for implantation in the human body. Should Buyer purchase or use **onsemi** products for any such unintended or unauthorized application, Buyer shall indemnify and hold **onsemi** and its officers, employees, subsidiaries, affiliates, and distributors harmless against all claims, costs, damages, and expenses, and reasonable attorney fees arising out of, directly or indirectly, any claim of personal injury or death associated with such unintended or unauthorized use, even if such claim alleges that **onsemi** was negligent regarding the design or manufacture of the part. **onsemi** is an Equal Opportunity/Affirmative Action Employer. This literature is subject to all applicable copyright laws and is not for resale in any manner.

ADDITIONAL INFORMATION

TECHNICAL PUBLICATIONS:

Technical Library: www.onsemi.com/design/resources/technical-documentation
onsemi Website: www.onsemi.com

ONLINE SUPPORT: www.onsemi.com/support

For additional information, please contact your local Sales Representative at www.onsemi.com/support/sales