

AC Input, Half Pitch Mini-Flat Package 4-Pin Optocoupler

HMHAA280

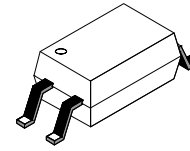

MPF4
 CASE 100AL

Description

The HMHAA280 series consists of two gallium arsenide infrared emitting diodes, connected in inverse parallel, driving a single silicon phototransistor in a compact 4-pin mini-flat package. The lead pitch is 1.27 mm.

Features

- Compact 4-pin Package (2.4 mm Maximum Standoff Height)
- Half Pitch Leads for Optimum Board Space Savings
- Current Transfer Ratio: 50–600%
- Available in Tape and Reel Quantities of 2500
- CSA (File #1201524), UL (File #E90700) and VDE (File #136480) Certified
- This is a Pb-Free Device

Applications

- AC Line Monitor
- Unknown Polarity DC Sensor
- Telephone Line Receiver

MARKING DIAGRAM

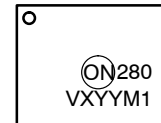

- ON = onsemi Logo
- 280 = Device Number
- V = VDE mark (Note: Only appears on parts ordered with VDE option – See order entry table)
- X = One-Digit Year Code
- YY = Digit Work Week, Ranging from “01” to “53”
- M1 = Assembly Package Code

PIN CONNECTIONS

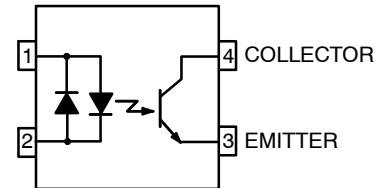

ORDERING INFORMATION

See detailed ordering and shipping information on page 5 of this data sheet.

HMHAA280

ABSOLUTE MAXIMUM RATINGS (T_A = 25°C, unless otherwise noted)

Symbol	Parameter	Value	Unit
--------	-----------	-------	------

TOTAL PACKAGE

T _{STG}	Storage Temperature	-55 to + 125	°C
T _{OPR}	Operating Temperature	-55 to + 100	°C

EMITTER

I _{F (avg)}	Continuous Forward Current	50	mA
I _{F (pk)}	Peak Forward Current (1μs pulse, 300 pps.)	1	A
V _R	Reverse Input Voltage	6	V
P _D	Power Dissipation Derate Linearly (above 25°C)	60 0.6	mW mW/°C

DETECTOR

	Continuous Collector Current	50	mA
P _D	Power Dissipation Derate Linearly (above 25°C)	150 1.5	mW mW/°C
V _{CEO}	Collector–Emitter Voltage	80	V
V _{ECO}	Emitter–Collector Voltage	7	V

ELECTRICAL CHARACTERISTICS (T_A = 25°C)

Symbol	Parameter	Test Condition	Min	Typ	Max	Unit
--------	-----------	----------------	-----	-----	-----	------

INDIVIDUAL COMPONENT CHARACTERISTICS

Emitter

V _F	Forward Voltage	I _F = ±5 mA	–	–	1.4	V
I _R	Reverse Current	V _R = 5 V	–	–	5	μA

Detector

BV _{CEO}	Breakdown Voltage Collector to Emitter	I _C = 0.5 mA, I _F = 0	80	–	–	V
BV _{ECO}	Emitter to Collector	I _E = 100 μA, I _F = 0	7	–	–	
I _{CEO}	Collector Dark Current	V _{CE} = 80 V, I _F = 0	–	–	100	nA
C _{CE}	Capacitance	V _{CE} = 0 V, f = 1 MHz	–	10	–	pF

TRANSFER CHARACTERISTICS

CTR	DC Current Transfer Ratio	I _F = ±5 mA, V _{CE} = 5 V	50	–	600	%
	CTR Symmetry	I _F = ±5 mA, V _{CE} = 5 V	0.33	–	3.0	
V _{CE(SAT)}	Saturation Voltage	I _F = ±8 mA, I _C = 2.4 mA	–	–	0.4	V
t _r	Rise Time (Non–Saturated)	I _C = 2 mA, V _{CE} = 5 V, R _L = 100 Ω	–	3	–	μs
t _f	Fall Time (Non–Saturated)	I _C = 2 mA, V _{CE} = 5 V, R _L = 100 Ω	–	3	–	μs

ISOLATION CHARACTERISTICS

V _{ISO}	Steady State Isolation Voltage	1 Minute	3750	–	–	VRMS
------------------	--------------------------------	----------	------	---	---	------

Product parametric performance is indicated in the Electrical Characteristics for the listed test conditions, unless otherwise noted. Product performance may not be indicated by the Electrical Characteristics if operated under different conditions.

*All typicals at T_A = 25°C.

TYPICAL PERFORMANCE CHARACTERISTICS

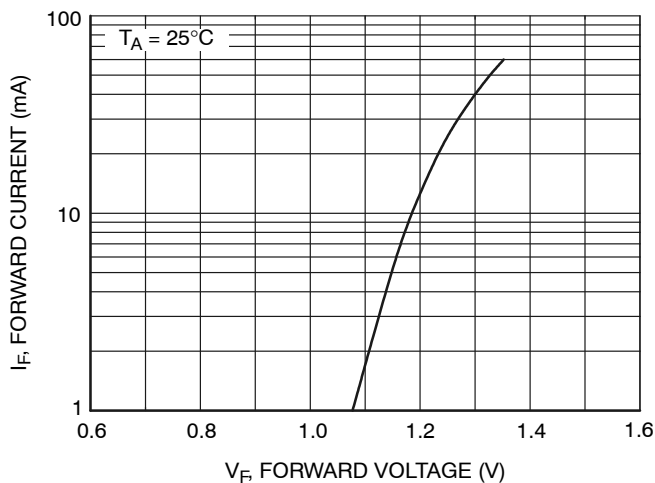

Figure 1. Forward Current vs. Forward Voltage

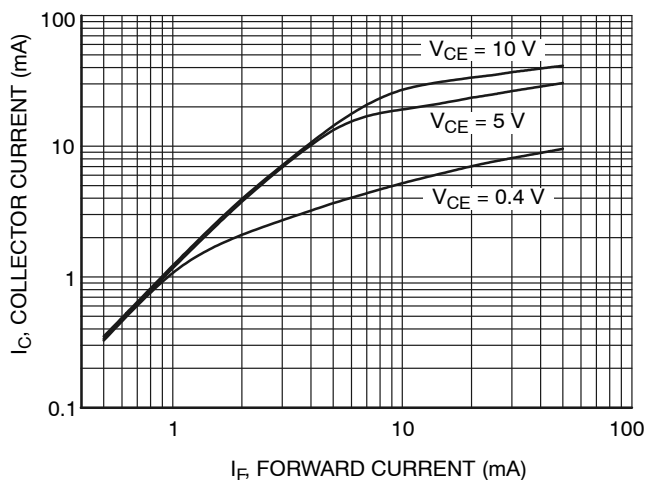

Figure 2. Collector Current vs. Forward Current

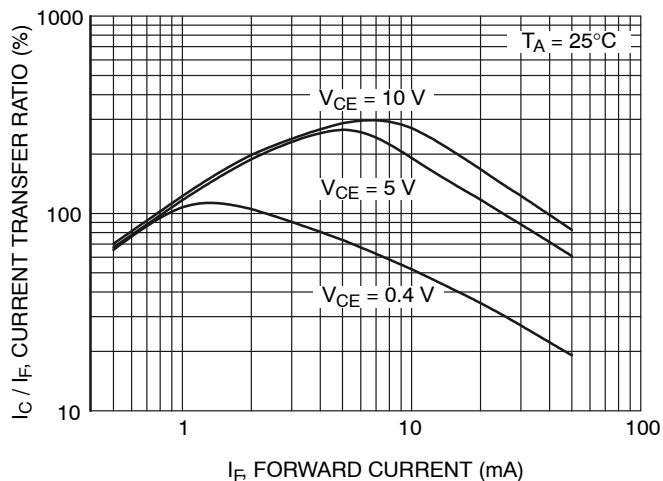

Figure 3. Current Transfer Ratio vs. Forward Current

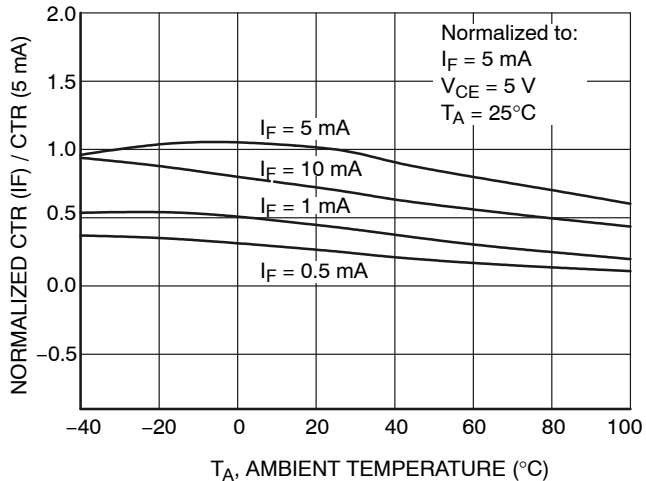

Figure 4. Normalized CTR vs. Temperature

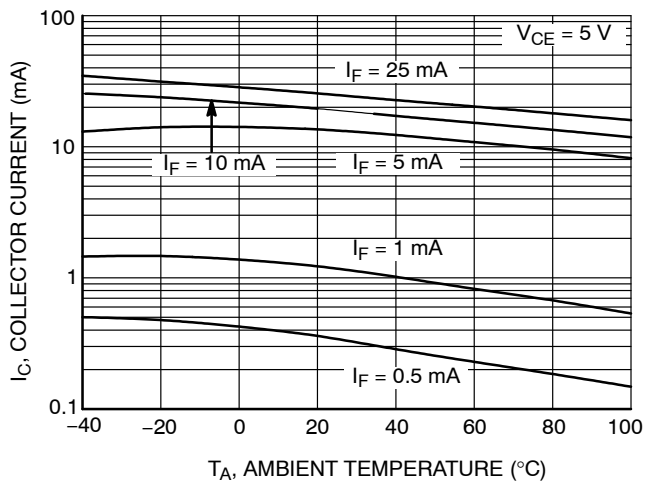

Figure 5. Collector Current vs. Temperature

TYPICAL PERFORMANCE CHARACTERISTICS (continued)

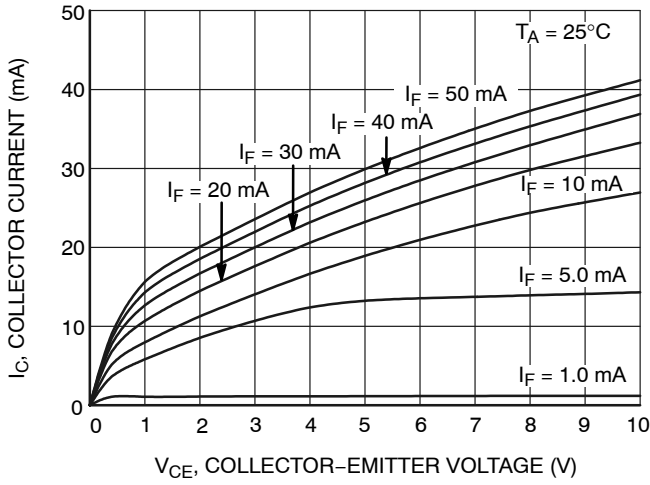

Figure 6. Collector Current vs. Collector-Emitter Voltage

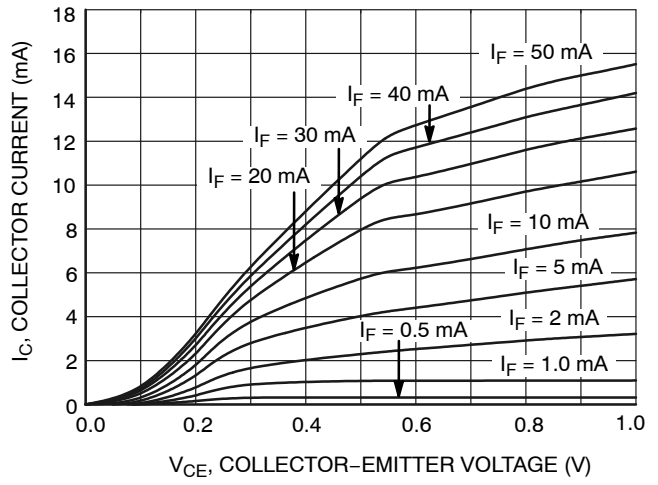

Figure 7. Collector Current vs. Collector-Emitter Voltage

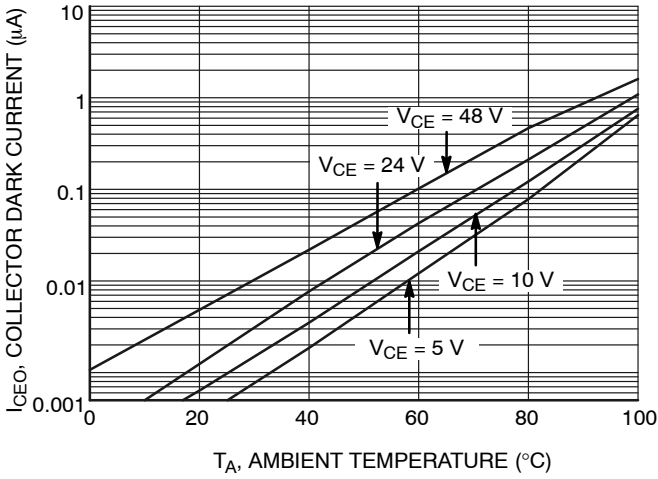

Figure 8. Collector Dark Current vs. Temperature

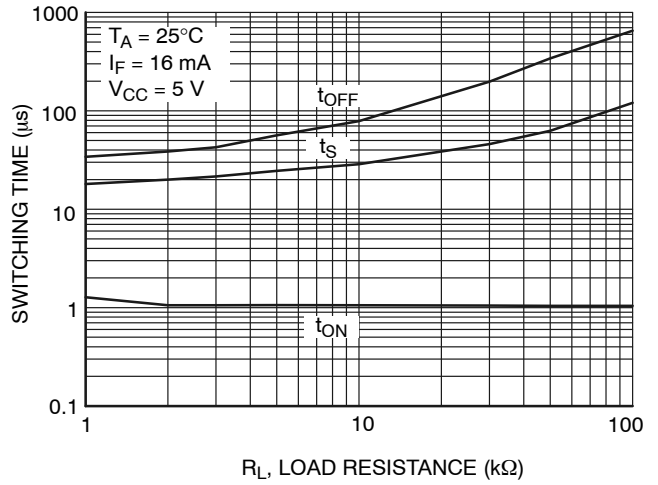

Figure 9. Switching Time vs. Load Resistance

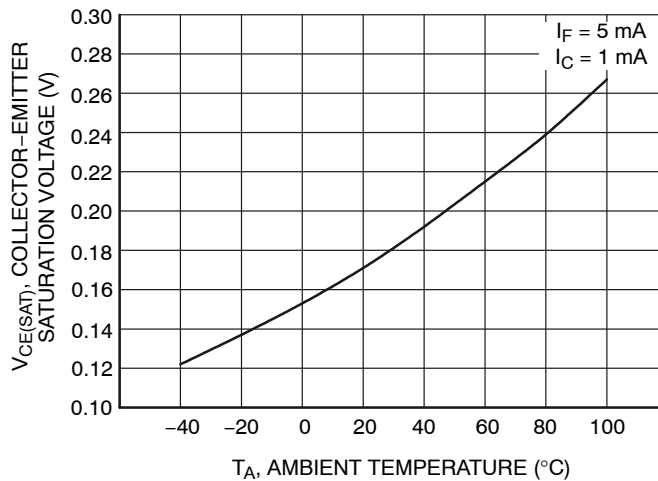
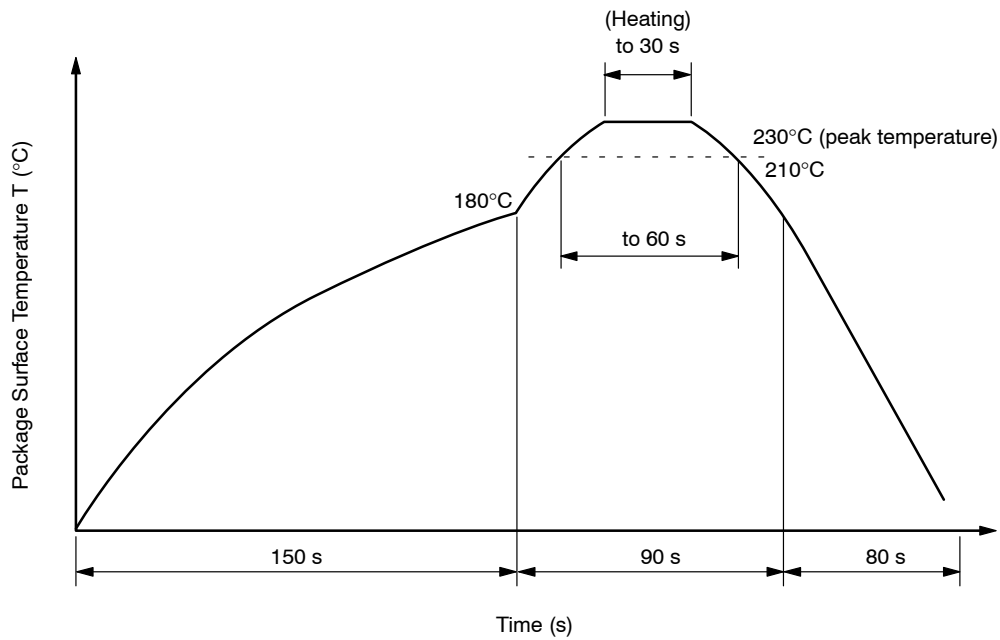

Figure 10. Collector-Emitter Saturation Voltage vs. Temperature

HMHAA280

REFLOW PROFILE



- Peak reflow temperature: 230°C (package surface temperature) for 30 seconds
- Time of temperature higher than 210°C: 60 seconds or less
- One time soldering reflow is recommended

*For applications requiring 260C peak reflow performance, please order FODM214 series.

ORDERING INFORMATION

Device	Package	Shipping [†]
HMHAA280	MFP-4	150 Units / Tube
HMHAA280R2	MFP-4	2500 / Tape & Reel
HMHAA280R2V	MFP-4, VDE Option	2500 / Tape & Reel
HMHAA280V	MFP-4, VDE Option	150 Units / Tube

†For information on tape and reel specifications, including part orientation and tape sizes, please refer to our Tape and Reel Packaging Specifications Brochure, [BRD8011/D](#).

MECHANICAL CASE OUTLINE
PACKAGE DIMENSIONS

ON Semiconductor®



MFP4 2.5X4.4, 1.27P
CASE 100AL
ISSUE O

DATE 31 AUG 2016

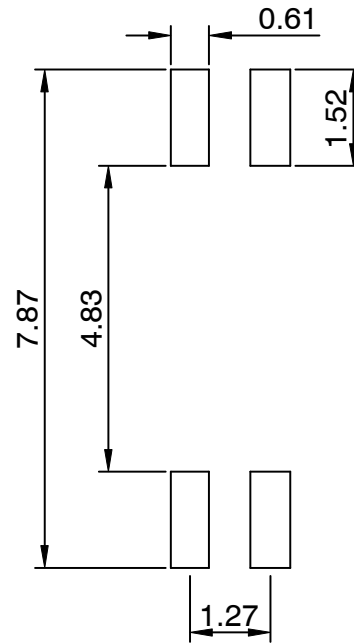
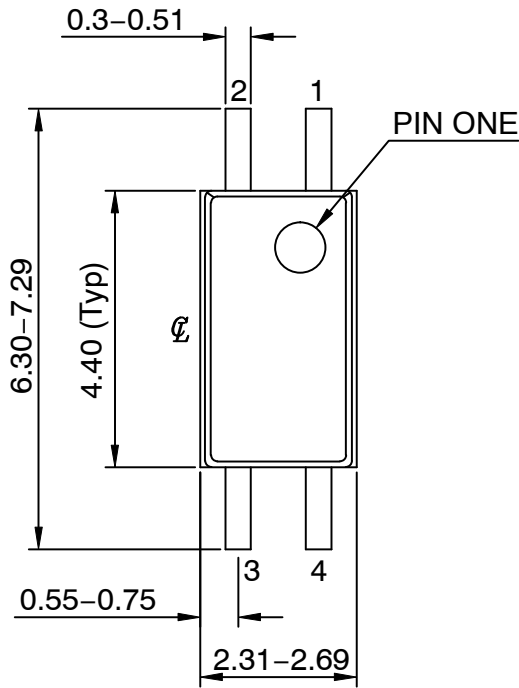

LAND PATTERN RECOMMENDATION

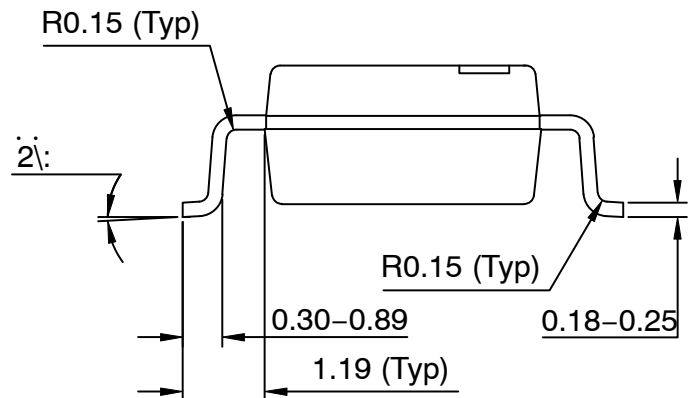
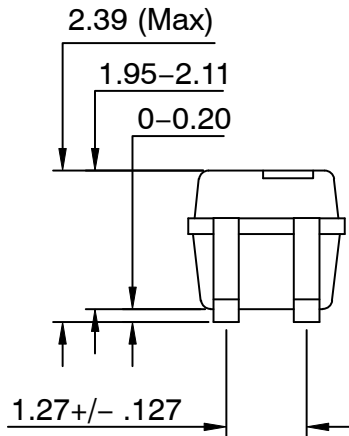

NOTES:

- A) NO STANDARD APPLIES TO THIS PACKAGE
- B) ALL DIMENSIONS ARE IN MILLIMETERS.
- C) DIMENSIONS ARE EXCLUSIVE OF BURRS, MOLD FLASH, AND TIE BAR EXTRUSION

DOCUMENT NUMBER:	98AON13485G	Electronic versions are uncontrolled except when accessed directly from the Document Repository. Printed versions are uncontrolled except when stamped "CONTROLLED COPY" in red.
DESCRIPTION:	MFP4 2.5X4.4, 1.27P	PAGE 1 OF 1

ON Semiconductor and are trademarks of Semiconductor Components Industries, LLC dba ON Semiconductor or its subsidiaries in the United States and/or other countries. ON Semiconductor reserves the right to make changes without further notice to any products herein. ON Semiconductor makes no warranty, representation or guarantee regarding the suitability of its products for any particular purpose, nor does ON Semiconductor assume any liability arising out of the application or use of any product or circuit, and specifically disclaims any and all liability, including without limitation special, consequential or incidental damages. ON Semiconductor does not convey any license under its patent rights nor the rights of others.

onsemi, **Onsemi**, and other names, marks, and brands are registered and/or common law trademarks of Semiconductor Components Industries, LLC dba "**onsemi**" or its affiliates and/or subsidiaries in the United States and/or other countries. **onsemi** owns the rights to a number of patents, trademarks, copyrights, trade secrets, and other intellectual property. A listing of **onsemi**'s product/patent coverage may be accessed at www.onsemi.com/site/pdf/Patent-Marking.pdf. **onsemi** reserves the right to make changes at any time to any products or information herein, without notice. The information herein is provided "as-is" and **onsemi** makes no warranty, representation or guarantee regarding the accuracy of the information, product features, availability, functionality, or suitability of its products for any particular purpose, nor does **onsemi** assume any liability arising out of the application or use of any product or circuit, and specifically disclaims any and all liability, including without limitation special, consequential or incidental damages. Buyer is responsible for its products and applications using **onsemi** products, including compliance with all laws, regulations and safety requirements or standards, regardless of any support or applications information provided by **onsemi**. "Typical" parameters which may be provided in **onsemi** data sheets and/or specifications can and do vary in different applications and actual performance may vary over time. All operating parameters, including "Typicals" must be validated for each customer application by customer's technical experts. **onsemi** does not convey any license under any of its intellectual property rights nor the rights of others. **onsemi** products are not designed, intended, or authorized for use as a critical component in life support systems or any FDA Class 3 medical devices or medical devices with a same or similar classification in a foreign jurisdiction or any devices intended for implantation in the human body. Should Buyer purchase or use **onsemi** products for any such unintended or unauthorized application, Buyer shall indemnify and hold **onsemi** and its officers, employees, subsidiaries, affiliates, and distributors harmless against all claims, costs, damages, and expenses, and reasonable attorney fees arising out of, directly or indirectly, any claim of personal injury or death associated with such unintended or unauthorized use, even if such claim alleges that **onsemi** was negligent regarding the design or manufacture of the part. **onsemi** is an Equal Opportunity/Affirmative Action Employer. This literature is subject to all applicable copyright laws and is not for resale in any manner.

ADDITIONAL INFORMATION

TECHNICAL PUBLICATIONS:

Technical Library: www.onsemi.com/design/resources/technical-documentation
onsemi Website: www.onsemi.com

ONLINE SUPPORT: www.onsemi.com/support

For additional information, please contact your local Sales Representative at www.onsemi.com/support/sales