

NPN Darlington Transistor

BC517

Features

- This Device is Designed for Applications Requiring Extremely High Current Gain at Currents to 1.0 A
- Sourced from Process 05
- This is a Pb-Free Device

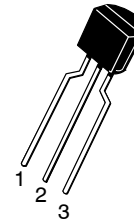

1. Collector
2. Base
3. Emitter

TO-92 3 4.825x4.76
LEADFORMER
CASE 135AR

ABSOLUTE MAXIMUM RATINGS (T_A = 25°C unless otherwise noted) (Note 1, 2)

Symbol	Parameter	Value	Unit
V _{CEO}	Collector-Emitter Voltage	30	V
V _{CBO}	Collector-Base Voltage	40	V
V _{EBO}	Emitter-Base Voltage	10	V
I _C	Collector Current - Continuous	1.2	A
T _J , T _{STG}	Operating and Storage Junction Temperature Range	-55 to +150	°C

Stresses exceeding those listed in the Maximum Ratings table may damage the device. If any of these limits are exceeded, device functionality should not be assumed, damage may occur and reliability may be affected.

1. These ratings are based on a maximum junction temperature of 150°C.
2. These are steady-state limits. onsemi should be consulted on applications involving pulsed or low-duty cycle operations.

THERMAL CHARACTERISTICS (T_A = 25°C unless otherwise noted) (Note 3)

Symbol	Parameter	Max (Note 3)	Unit
P _D	Total Device Dissipation, T _A = 25°C	625	mW
	Derate Above 25°C	5.0	mW/°C
R _{θJC}	Thermal Resistance, Junction to Case	83.3	°C/W
R _{θJA}	Thermal Resistance, Junction to Ambient	200	°C/W

3. PCB size: FR-4 76 x 114 x 1.57 mm³ (3.0 inch x 4.5 inch x 0.062 inch) with minimum land pattern size.

ELECTRICAL CHARACTERISTICS (T_A = 25°C unless otherwise noted)

Symbol	Parameter	Conditions	Min	Typ	Max	Unit
V _{CEO}	Collector-Emitter Breakdown Voltage	I _C = 2.0 mA, I _B = 0	30	-	-	V
V _{CBO}	Collector-Base Breakdown Voltage	I _C = 10 μA, I _E = 0	40	-	-	V
V _{EBO}	Emitter-Base Breakdown Voltage	I _E = 100 nA, I _C = 0	10	-	-	V
I _{CB0}	Base Cut-Off Current	V _{CB} = 30 V, I _E = 0	-	-	100	nA
h _{FE}	DC Current Gain	V _{CE} = 2 V, I _C = 20 mA	30,000	-	-	
V _{CE(sat)}	Collector-Emitter Saturation Voltage	I _C = 100 mA, I _B = 0.1 mA	-	-	1	V
V _{BE(on)}	Base-Emitter On Voltage	I _C = 10 mA, V _{CE} = 5.0 V	-	-	1.4	V

Product parametric performance is indicated in the Electrical Characteristics for the listed test conditions, unless otherwise noted. Product performance may not be indicated by the Electrical Characteristics if operated under different conditions.

MARKING DIAGRAM

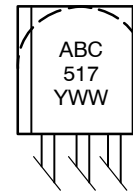

- BC517 = Specific Device Code
A = Assembly Site
Y = Year of Production
WW = Work Week Number

ORDERING INFORMATION

Device	Package	Shipping
BC517-D74Z	TO-92-3 LF	2000 Units / Fan-Fold

TYPICAL PERFORMANCE CHARACTERISTICS

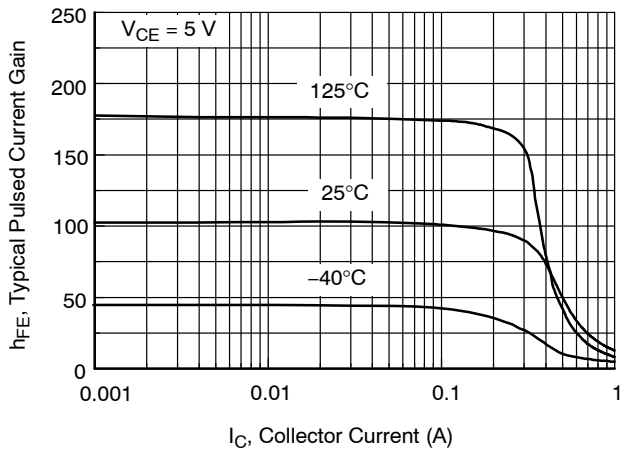

Figure 1. Typical Pulsed Current Gain vs. Collector Current

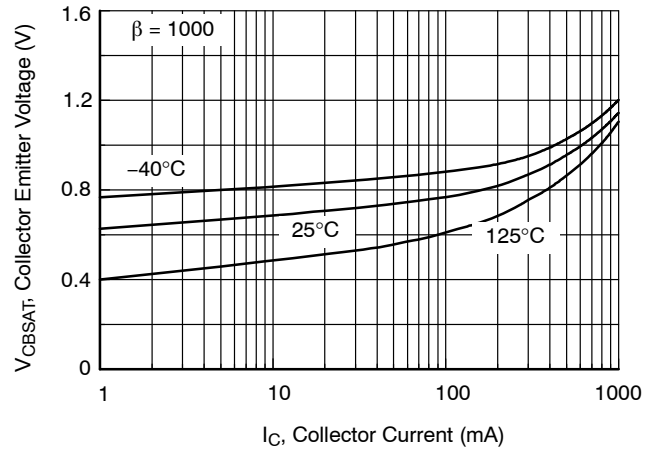

Figure 2. Collector-Emitter Saturation Voltage vs. Collector Current

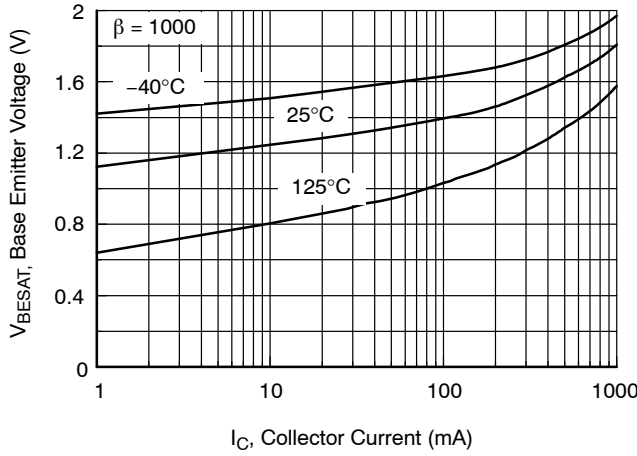

Figure 3. Base-Emitter Saturation Voltage vs. Collector Current

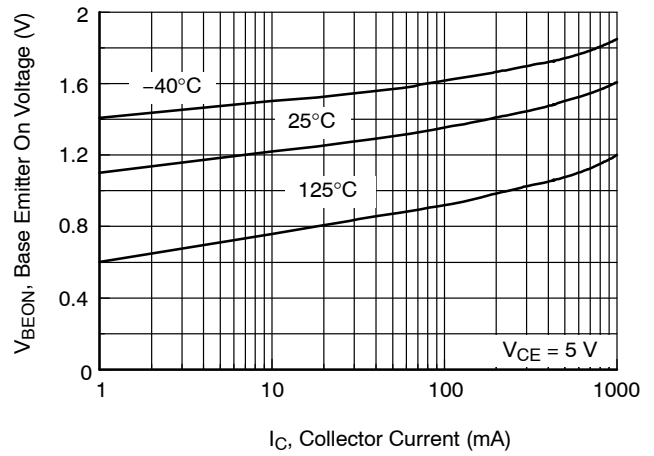

Figure 4. Base-Emitter On Voltage vs. Collector Current

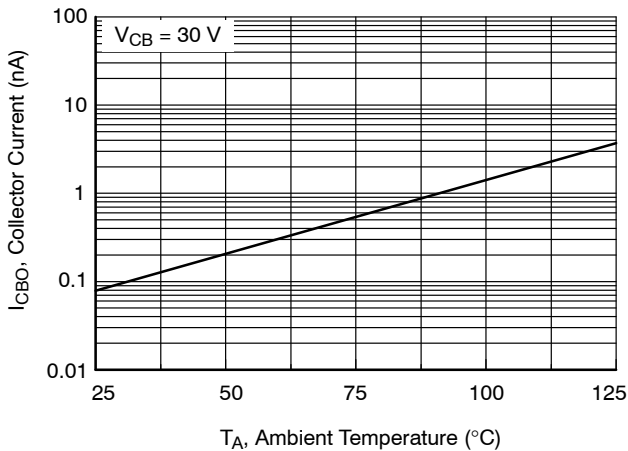

Figure 5. Collector Cut-Off Current vs. Ambient Temperature

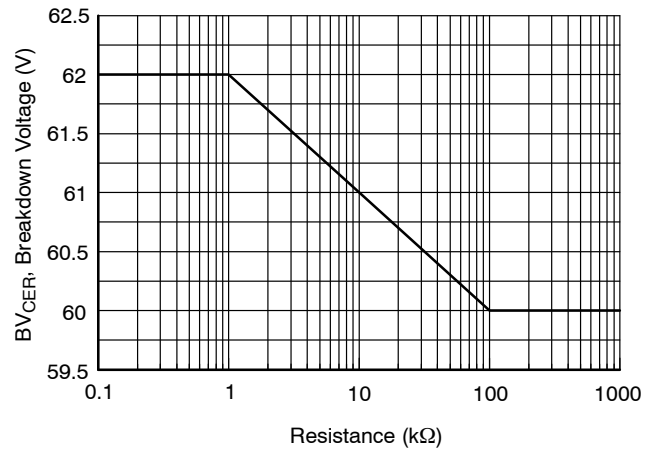

Figure 6. Collector-Emitter Breakdown Voltage with Resistance Between Emitter-Base

TYPICAL PERFORMANCE CHARACTERISTICS (continued)

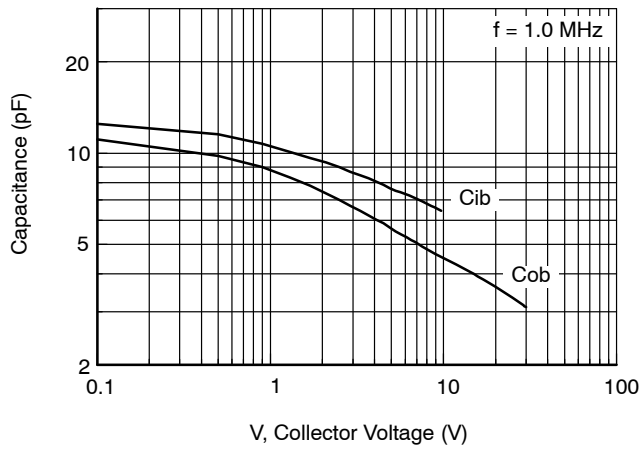

Figure 7. Input and Output Capacitance vs. Reverse Voltage

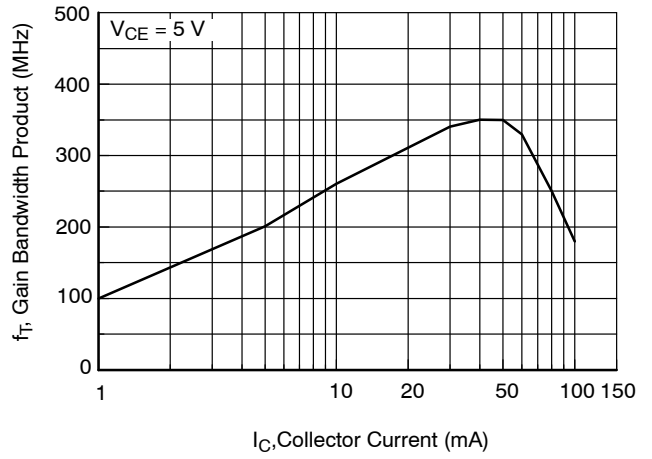

Figure 8. Gain Bandwidth Product vs. Collector Current

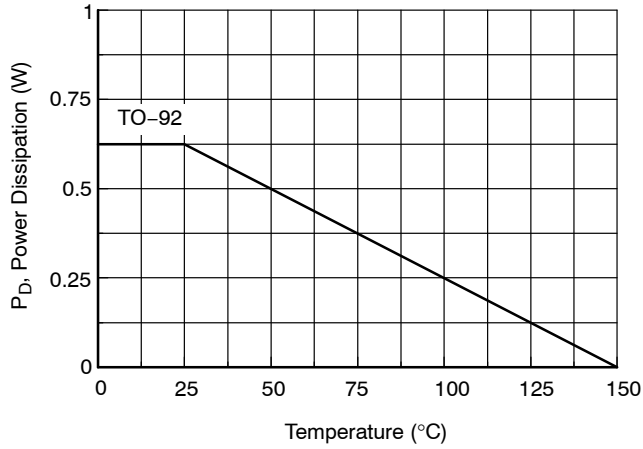
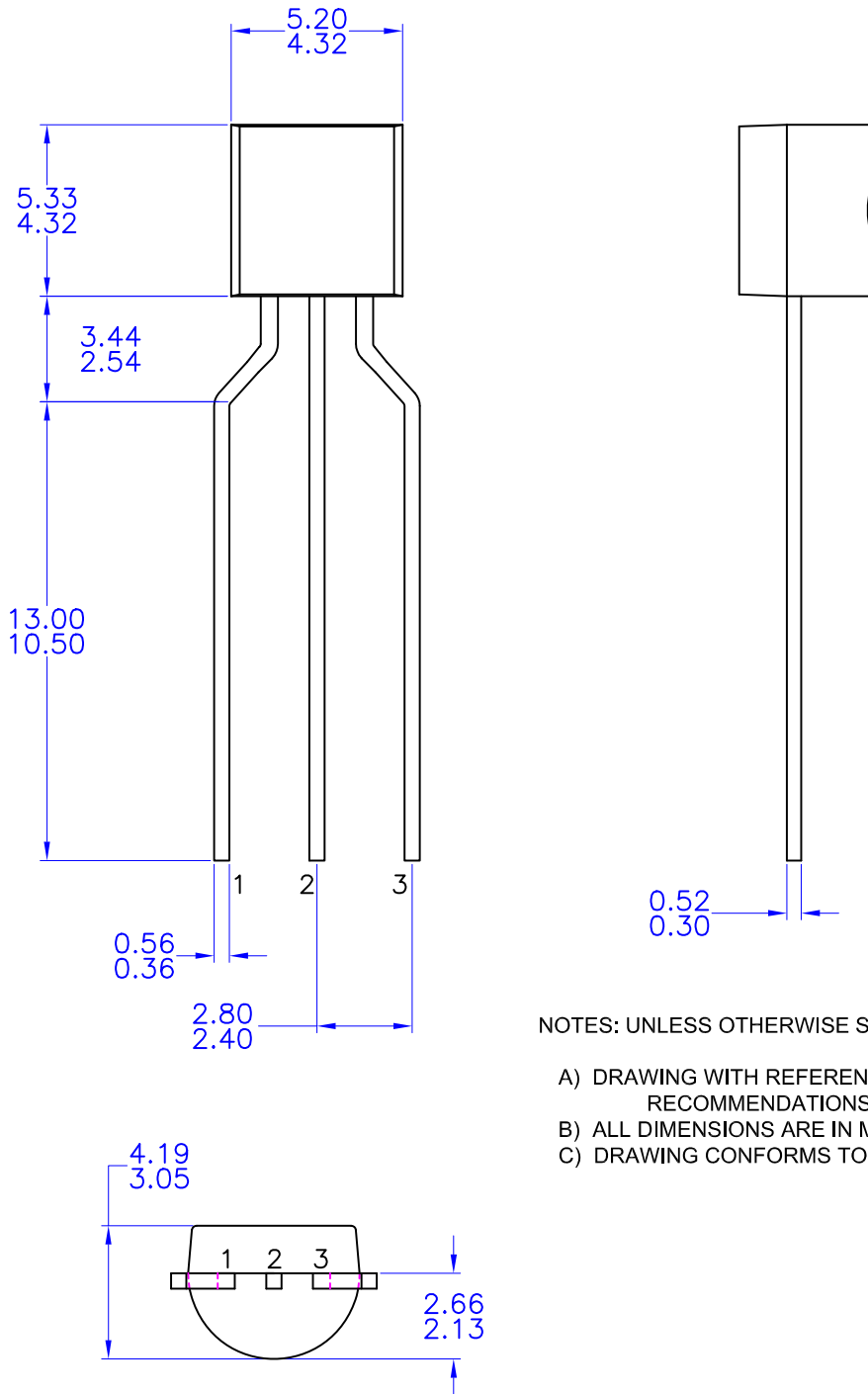

Figure 9. Power Dissipation vs. Ambient Temperature

TO-92 3 4.83x4.76 LEADFORMED
CASE 135AR
ISSUE O

DATE 30 SEP 2016



NOTES: UNLESS OTHERWISE SPECIFIED

- A) DRAWING WITH REFERENCE TO JEDEC TO-92 RECOMMENDATIONS.
- B) ALL DIMENSIONS ARE IN MILLIMETERS.
- C) DRAWING CONFORMS TO ASME Y14.5M-1994

DOCUMENT NUMBER:	98AON13879G	Electronic versions are uncontrolled except when accessed directly from the Document Repository. Printed versions are uncontrolled except when stamped "CONTROLLED COPY" in red.
DESCRIPTION:	TO-92 3 4.83X4.76 LEADFORMED	PAGE 1 OF 1

ON Semiconductor and  are trademarks of Semiconductor Components Industries, LLC dba ON Semiconductor or its subsidiaries in the United States and/or other countries. ON Semiconductor reserves the right to make changes without further notice to any products herein. ON Semiconductor makes no warranty, representation or guarantee regarding the suitability of its products for any particular purpose, nor does ON Semiconductor assume any liability arising out of the application or use of any product or circuit, and specifically disclaims any and all liability, including without limitation special, consequential or incidental damages. ON Semiconductor does not convey any license under its patent rights nor the rights of others.

onsemi, **Onsemi**, and other names, marks, and brands are registered and/or common law trademarks of Semiconductor Components Industries, LLC dba "**onsemi**" or its affiliates and/or subsidiaries in the United States and/or other countries. **onsemi** owns the rights to a number of patents, trademarks, copyrights, trade secrets, and other intellectual property. A listing of **onsemi**'s product/patent coverage may be accessed at www.onsemi.com/site/pdf/Patent-Marking.pdf. **onsemi** reserves the right to make changes at any time to any products or information herein, without notice. The information herein is provided "as-is" and **onsemi** makes no warranty, representation or guarantee regarding the accuracy of the information, product features, availability, functionality, or suitability of its products for any particular purpose, nor does **onsemi** assume any liability arising out of the application or use of any product or circuit, and specifically disclaims any and all liability, including without limitation special, consequential or incidental damages. Buyer is responsible for its products and applications using **onsemi** products, including compliance with all laws, regulations and safety requirements or standards, regardless of any support or applications information provided by **onsemi**. "Typical" parameters which may be provided in **onsemi** data sheets and/or specifications can and do vary in different applications and actual performance may vary over time. All operating parameters, including "Typicals" must be validated for each customer application by customer's technical experts. **onsemi** does not convey any license under any of its intellectual property rights nor the rights of others. **onsemi** products are not designed, intended, or authorized for use as a critical component in life support systems or any FDA Class 3 medical devices or medical devices with a same or similar classification in a foreign jurisdiction or any devices intended for implantation in the human body. Should Buyer purchase or use **onsemi** products for any such unintended or unauthorized application, Buyer shall indemnify and hold **onsemi** and its officers, employees, subsidiaries, affiliates, and distributors harmless against all claims, costs, damages, and expenses, and reasonable attorney fees arising out of, directly or indirectly, any claim of personal injury or death associated with such unintended or unauthorized use, even if such claim alleges that **onsemi** was negligent regarding the design or manufacture of the part. **onsemi** is an Equal Opportunity/Affirmative Action Employer. This literature is subject to all applicable copyright laws and is not for resale in any manner.

ADDITIONAL INFORMATION

TECHNICAL PUBLICATIONS:

Technical Library: www.onsemi.com/design/resources/technical-documentation
onsemi Website: www.onsemi.com

ONLINE SUPPORT: www.onsemi.com/support

For additional information, please contact your local Sales Representative at www.onsemi.com/support/sales